



**ROLE AND  
MANDATE OF THE  
MINISTRY**

### Role and Mandate of the Ministry

#### Role of the Ministry

The primary concerns of the Ministry of Environment & Forests under the Government structure are implementation of policies and programmes relating to conservation of the country's natural resources including lakes and rivers, its biodiversity, forests and wildlife, ensuring the welfare of animals and prevention and abatement of pollution. While implementing these policies and programmes, the Ministry is guided by the principle of sustainable development and enhancement of human well-being. The Ministry also serves as the nodal agency in the country for the United Nations Environment Programme (UNEP), South Asia Co-operative Environment Programme (SACEP), International Centre for Integrated Mountain Development (ICIMOD) and for the follow-up of the United Nations Conference on Environment and Development (UNCED). The Ministry is also entrusted with the issues relating to multilateral bodies such as the Commission on Sustainable Development (CSD), Global Environment Facility (GEF) and of regional bodies like Economic and Social Council for Asia and Pacific (ESCAP) and South Asian Association for Regional Co-operation (SAARC) on matters pertaining to environment.

The broad objectives of the Ministry are:

- Conservation and survey of flora, fauna, forests and wildlife,
- Prevention and control of pollution,
- Afforestation and regeneration of degraded areas,

- Protection of the environment, and
- Ensuring the welfare of animals.

These objectives are well supported by a set of legislative and regulatory measures, aimed at the preservation, conservation and protection of the environment. Besides the legislative measures, a National Conservation Strategy and Policy Statement on Environment and Development, 1992, National Forest Policy, 1988, a Policy Statement on Abatement of Pollution, 1992 and a National Environment Policy, 2006 have also been evolved.

The organization structure of the Ministry indicating various Divisions and its autonomous and subordinate offices is given at Annexure- I-A & I-B.

#### Mandate of the Ministry

##### Allocation of Business

- Environment and Ecology, including environment in coastal waters, in mangroves and coral reefs but excluding marine environment on the high seas.
- Survey and Exploration of Natural Resources particularly of Forest, Flora, Fauna, Ecosystems etc.
- Bio-diversity Conservation including that of lakes and wetlands.
- Conservation, development, management and abatement of pollution of rivers which shall include National River Conservation Directorate.
- Environmental Impact Assessment.

## Annual Report 2009-2010

- Environment research and development, education, training, information and awareness.
- Environmental Health.
- Forest Development Agency and Joint Forest Management Programme for conservation, management and afforestation.
- Wildlife conservation, preservation, protection planning, research, education, training and awareness including Project Tiger and Project Elephant.
- International co-operation on issues concerning Environment, Forestry and Wildlife.
- Botanical Survey of India and Botanical Gardens.
- Zoological Survey of India.
- National Museum of Natural History.
- Biosphere Reserve Programme.
- National Forest Policy and Forestry Development in the country including Social Forestry.
- All matters relating to Forest and Forest Administration in the Andaman and Nicobar Islands.
- Indian Forest Service.
- Wild Life Preservation and protection of wild birds and animals.
- Fundamental and applied research and training including higher education in forestry.
- Padmaja Naidu Himalayan Zoological Park.
- National Assistance to Forestry Development Schemes.
- Indian Plywood Industries Research and Training Institute, Bangalore.
- Afforestation and Eco-development which shall include National Afforestation and Eco-Development Board.
- Desert and Desertification.
- Forest Survey of India.
- Indian Institute of Bio-diversity, Itanagar.
- Central Pollution Control Board.
- G.B. Pant Institute of Himalayan Environment & Development.
- Wildlife Institute of India and Indian Board for Wildlife.
- Indian Institute of Forest Management.
- Central Zoo Authority including National Zoological Park.
- Indian Council of Forestry Research & Education.
- Andaman and Nicobar Islands Forest and Plantation Development Corporation Limited.
- Prevention of Cruelty to Animals.
- Matters relating to pounds and cattle trespass.
- Gaushalas and Gausadans.
- The Prevention of Cruelty to Animals Act, 1960 (59 of 1960).
- The National Environment Tribunal Act, 1995 (27 of 1995).



## Ministry of Environment & Forests

---

- The National Environment Appellate Authority Act, 1997 (22 of 1997).
- The Water Prevention and Control of Pollution Act, 1974 (6 of 1974).
- The Water (Prevention and Control of Pollution) Cess Act, 1977 (36 of 1977).
- The Air (Prevention and Control of Pollution) Act, 1981 (14 of 1981).
- The Indian Forest Act, 1927 (16 of 1927).
- The Wildlife (Protection) Act, 1972 (53 of 1972).
- The Forest (Conservation) Act, 1980 (69 of 1980).
- The Environment (Protection), Act, 1986 (29 of 1986).
- The Public Liability Insurance Act, 1991 (6 of 1991).

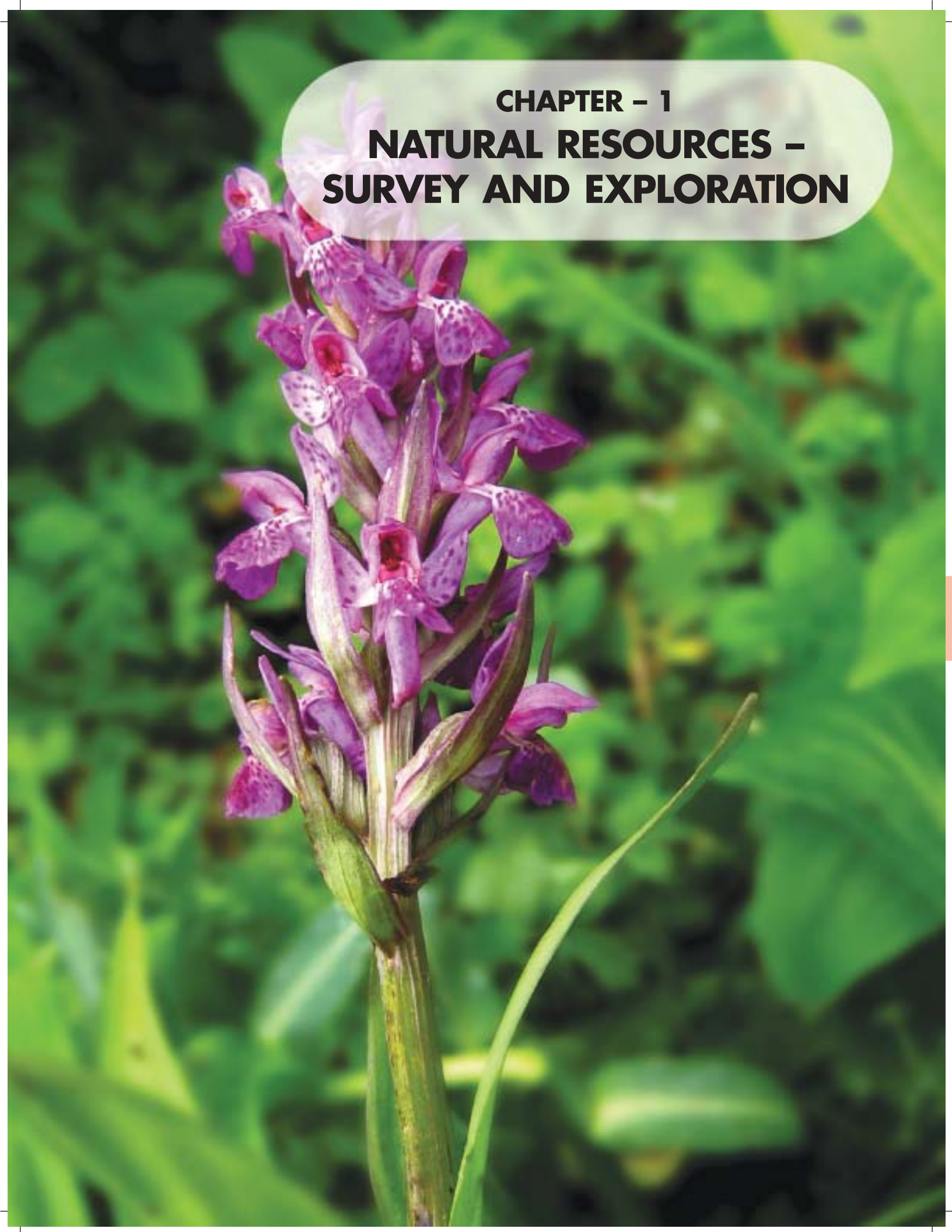

**CHAPTER - 1**  
**NATURAL RESOURCES -**  
**SURVEY AND EXPLORATION**

## Survey of Flora

### Botanical Survey of India

#### Introduction

The Botanical Survey of India (BSI) is the apex research organization under the Ministry of Environment and Forests, Government of India for carrying out taxonomic and floristic studies on wild plant resources of the country. It was established on 13<sup>th</sup> February, 1890 with the basic objective to explore the plant resources of the country and to identify the plants species with economic virtues. Sir George King, the then Superintendent of the 'Royal Botanic Garden' Calcutta was appointed as First ex-officio Honorary Director of the BSI. After independence the department was reorganized in 1954 by Government of India as a part of scientific development of the country. During the successive plan periods, the functional base of BSI was further expanded to include various new areas such as inventorying of endemic, rare and threatened plant species; evolving conservation strategies; studies on fragile ecosystems and protected areas, like wildlife sanctuaries, national parks and biosphere reserves; multiplication and maintenance of endemic and threatened plant species, wild ornamentals, etc., in Botanic Gardens and Orchidaria; documentation of traditional knowledge associated with plants and development of National Database of herbarium and live collections, plant distribution and nomenclature, botanical paintings/illustrations, plant uses, etc.

#### Objectives

The primary objectives of BSI are as follows:

- Exploration, inventorying and documentation of phytodiversity in general and protected areas, hotspots and fragile ecosystems in particular; publication of National, State and District Floras.
- Identification of threatened/red list species and species rich areas needing conservation; *ex-situ* conservation of critically threatened species in botanical gardens.
- Survey and documentation of traditional knowledge (ethno-botany) associated with plants.
- Develop a National database of Indian plants, including herbarium and live specimens, botanical paintings/illustrations, etc.

The secondary objectives are:

- Revisionary/Monographic studies on selected plant groups.
- Qualitative analysis of nutritive value of ethno-food plants and other economically useful species.
- Capacity building in plant taxonomy through refresher courses and post M.Sc. certificate course.
- Environment Impact Assessment of areas assigned by the ministry.
- Develop and maintain Botanical Gardens, Museums and Herbaria.
- Preparation of Seed, Pollen and Spore Atlas of Indian Plants.



Fig-1. An orchid – beauty of the forests

### Activities undertaken during the year

#### Botanical Exploration and Inventorisation of Phytodiversity

#### Field tours and Herbarium consultation tours

Fifty-two field tours were undertaken for floristic/ethnobotanical and other studies of higher and lower groups of plants by different regional centres and units of BSI covering the following areas:

- Western Himalaya: Himachal Pradesh (*Haripurdhar*), Uttarakhand (*Govind Pashu Vihar, Pithoragarh, Dokriani glacier, Dingad valley and Hurraglacier valley, Pauri Garhwal & Rishikesh*).
- Eastern Himalaya: Sikkim (West and South districts)
- North – East India: Arunachal Pradesh (*Kurum Kumey, Delei valley*), Assam (*Gibbon wildlife Sanctuary and Pani Dihing Wildlife Sanctuary*), Manipur (*Senapati and Tamenglong*), Meghalaya (*Ribhoi*)
- Arid – Semi Arid: Gujarat, Punjab, Haryana, Rajasthan

- Gangetic Plains: Uttar Pradesh, Bihar, Jharkhand (*Dalma Wildlife Sanctuary*), West Bengal (*Buxa National Park*)

- Deccan Peninsula: Madhya Pradesh, Chattisgarh, Maharashtra, Tamil Nadu

- Western Ghats: Maharashtra, Karnataka (*Mookambika Wildlife Sanctuary*), Goa (*Netravali Wildlife Sanctuary, Cotigaon Wildlife Sanctuary, Madei & Bondla Wildlife Sanctuaries and Dr. Salim Ali Bird Sanctuary*), Kerala, Tamil Nadu

- East Coast: Orissa, Andhra Pradesh, Tamil Nadu (*Pulicat Lake to Kodiakarai*)

- Islands: Andaman (*Chidiyatapu*) & Nicobar, Lakshadweep

During field tours, ca one thousand nine hundred fifty specimens have been collected. One thousand three hundred forty of these collected specimens belonging to ca three hundred twenty species were identified by scientists of different regional centres and units which resulted to discovery of one genus and twenty five species as new to science and twenty one species as new to India.

#### Genus new to Science

- *Cymbidiopsis* H.J. Chowdhery (Orchidaceae) – a new genus

#### Species new to science

- *Aporosa indo-acuminata* T. Chakrabarty & N.P. Balakrishnan (Euphorbiaceae, *sens. lat.*)
- *Aralia devendrae* Pusalkar (Araliaceae)
- *Bambusa majumdarii* P. Kumari & P. Singh (Poaceae: Bambusoidae)



Fig-2. *Caltha palustris*, commonly known as Kingcup or Marsh Marigold. Skin rashes and dermatitis have been reported from excessive handling of the plant.

- *Cryptothecia multipunctata* Jagadeesh Ram, G.P. Sinha & Kr.P. Singh (Arthoniaceae)
- *Cryptothecia verruculifera* Jagadeesh Ram, G.P. Sinha & Kr.P. Singh (Arthoniaceae)
- *Herpothallon granulorum* Jagadeesh Ram & G.P. Sinha (Arthoniaceae)
- *Herpothallon isidiatum* Jagadeesh Ram & G.P. Sinha (Arthoniaceae)
- *Phyllanthus rangachariarii* C. Murugan, K. A. A. Kabeer & G. V. S. Murthy (Euphorbiaceae)
- *Bambusa mohanramii* P. Kumari & P. Singh (Poaceae: Bambusoidae)
- *Bambusa nairaina* P. Kumari & P. Singh (Poaceae: Bambusoidae)
- *Berchemia jainiana* P. K. Pusalkar & D. K. Singh (Rhamnaceae)
- *Bhesa andamanica* N. Balachandran & T. Chakrabarty (Celastraceae)
- *Canscora sanjappae* P. G. Diwakar & R. Kr. Singh (Gentianaceae)
- *Coriaria duthie* D. K. Singh & Pusalkar (Coriariaceae)
- *Corydalis kedarensis* Pusulkar & D. K. Singh (Fumariaceae)
- *Cryptothecia alboglauca* Jagadeesh Ram, G.P. Sinha & Kr.P. Singh (Arthoniaceae)
- *Cryptothecia bengalensis* Jagadeesh Ram, G.P. Sinha & Kr.P. Singh (Arthoniaceae)
- *Cryptothecia farinosa* Jagadeesh Ram, G.P. Sinha & Kr.P. Singh (Arthoniaceae)
- *Sageratia devendrae* Pusalkar (Rhamnaceae)
- *Sageratia santapauui* Pusalkar & D. K. Singh (Rhamnaceae)
- *Saurauia nicobarica* T. K. Paul (Actinidiaceae)
- *Saurauia parasnathensis* V. Ranjan & S.C. Srivast. (Actinidiaceae)
- *Saxifraga assamensis* B. M. Wadhwa (Saxifragaceae)
- *Vaccinium amakhangium* S. Panda & Sanjappa (Ericaceae)

#### New Records for India

- *Cololejeunea longiana* Grolle & Mizut. (Lejeuneaceae)
- *Combretum trifoliatum* Vent. (Combretaceae)
- *Cotricia vallata* (Berk.) Teng (Hymenochaetaceae)
- *Delphinium nordhagenii* Wendelbo (Ranunculaceae)



- *Erythrodecton malacum* (Kremp.) G. Thor. (Roccellaceae)
- *Ginalloa helferi* Kurz (Viscaceae)
- *Goodenia koningsbergeri* (Back.) Back. ex Bold. (Goodeniaceae)
- *Herpothallon australasicum* (Elix) Elix & G. Thor (Arthoniaceae)
- *Herpothallon granulare* (Sipman) Aptroot & Lücking (Arthoniaceae)
- *Herpothallon albidum* (Fée) Aptroot, Lücking & G. Thor (Arthoniaceae)
- *Herpothallon cinereum* G. Thor (Arthoniaceae)
- *Herpothallon philippinum* (Vain.) Aptroot & Lücking (Arthoniaceae)
- *Impatiens harae* var. *micrantha* (Hara) & S. Akiyama (Balsaminaceae)
- *Lejeunea papilionaceae* Steph. (Lejeuneaceae)
- *Lindera cercidifolia* Hemsl. (Lauraceae)
- *Opegrapha agelaeotera* Vain. (Roccellaceae)
- *Opegrapha subrimulosa* Nyl. (Roccellaceae)
- *Saccogyndium irregularospinum* Gao et al. (Geocalycaceae) – a new generic record.
- *Saussurea forestii* Grolle. (Asteraceae)
- *Sciaphilla secundiflora* Thwaites ex Benth. (Triuridaceae)

- *Sesbania sericea* (Willd.) Link (Leguminosae)

### Documentation of Phytodiversity National Flora (Flora of India)

- Taxonomic description of families Acanthaceae (Subtribe: Justiciinae), Nyctaginaceae, Lauraceae, Salicaceae, Cyperaceae (Tribe: Rynchosporaceae, Hypolyteae & Sclerieae), Ranunculaceae (Genus: *Ranunculus*), Juncaceae, Begoniaceae have been completed and submitted for publication.
- An annotated Checklist of Lichens (Two thousand two hundred thirty one species) and Marine algae (eight hundred forty species) of India have been completed and submitted for publication.
- Checklist of Cyanophyceae (c. one thousand one hundred ninety species) and Chlorophyceae (c. one thousand five hundred species) has been completed



Fig-3. An Alpine orchid

### Regional/State Flora

- Taxonomic description for Flora of Mizoram (Volume III), Manipur (Volume II), Nagaland (Volume I and Volume IV), Uttar Pradesh (Volume I), Jammu & Kashmir (Volume IV) and Kerala (Volume II) have been completed and submitted for publication.
- Flora of Upper Siang District and Bryophytic Flora of Lohit district of Arunachal Pradesh has been completed and submitted for publication.

### Protected Areas

- Taxonomic description for Flora of Ballavpur Wildlife Sanctuary, Kyangnolsa Alpine Sanctuary, Tendong Reserve Forest, Maenam Wildlife Sanctuary, Dampa Tiger Reserve, Mehao Wildlife Sanctuary and Fumbonglho Wildlife Sanctuary have been completed and submitted for publication.
- Bryophytic Flora of Mehao Wildlife Sanctuary of Arunachal Pradesh has been completed and submitted for publication.

### Documentation of Indigenous Knowledge of Plant Resources

- Five tours to Jharsaguda, Angul, Bolangir and Gajapati districts carried out and ethno-botanical uses of ca. two hundred seventy four species recorded, which includes one hundred ninety two medicinal, sixty five of food value and seventeen of veterinary uses.

### Ex-situ Conservation in Botanic Gardens

- Thirty six rare endangered species have been introduced for, acclimatization and multiplication for ex-situ conservation of and economically important plants in Acharya Jagadish Chandra Bose Indian Botanic Garden, Howrah, Botanic Garden of Indian

Republic (BGIR), NOIDA and in the Associated Botanic Gardens of different Regional Centres of BSI.

- Indigenous saplings and seedlings of medicinal plants have been procured from different parts of Terai region and Orissa for BGIR, NOIDA. Planting of seedlings in Terai division of the garden completed. About seven hundred seedlings of twelve plant species have been raised successfully.
- Introduced and maintained three rare Zingibers, two rare Orchids and thirty seven medicinally/economically important species in Botanic Garden, Barapani, Shillong. Stock cultures of *Paphiopedilum* spp., *Cymbidium tigrinum*, *Nepenthes khasiana* were subcultured onto fresh medium and maintained.



Fig-4. *Rheum nobile* – an alpine plant of Sikkim

### Monitoring of Botanic Gardens

- During the period BSI monitored the conservation of rare threatened species in fourteen botanical gardens funded by MoEF under the 'Assistance to Botanic Garden' Scheme and submitted the reports.
- Reviewed thirty four project proposals under 'Assistance to Botanic Garden' scheme of MoEF.

### Miscellaneous

#### Public Services rendered

BSI disseminated scientific information to public and also assisted scientists, students and researchers in their pursuit of taxonomic research on plants. During the period scientists, students and visitors, including nineteen VIPs, have visited the Botanic Gardens, Herbaria and Museums of BSI; one hundred eighty five requests for information and supply of plant materials have been attended. Identified one hundred sixty nine plant materials.

#### e-Governance initiatives

- The 1<sup>st</sup> project of *Conservation, Restoration and Digitisation of the Old Archival Documents/Correspondences/Manuscripts & Herbarium Specimens at Industrial Section Indian Museum, Kolkata* has been sanctioned by MoEF and digitization work has been initiated by the successful vendor. The firm has been selected for execution of the 2<sup>nd</sup> project of *Conservation, Restoration and Digitisation of the Historic Forbes Watson and Thomas Wardle Volumes on Textiles and Natural Dyes and Botanical paintings at Industrial Section Indian Museum, Kolkata* & letter for sanction of project has been sent to MoEF.

- LAN and WAN connectivity through leased line has been completed at AJC Bose IBG Complex
- Data Centre and Data Production Line have been commissioned
- Beta testing of Application Software for Indian Virtual herbarium has been completed
- Two hundred ten Officials of BSI has been trained on *Concepts of IT & Office Suite* through Computer Maintenance Corporation (CMC).

### Publications

During the period BSI published the following books:

1. Hepaticae & Anthocerotae of Great Himalayan National Park, Himachal Pradesh
2. Flora of Pin Valley National Park, Himachal Pradesh
3. *Vanaspati Anveshan 2008* (in Hindi)
4. Plant Discoveries 2008
5. Floristic Diversity of Tiger Reserves of India
6. *Vanaspati Vani*, Vol.18 (in Hindi)
7. ENVIS News Letter Vols. 13 (2).
8. ENVIS News Letter Vols. 14 (1).
9. Flora of Tamil Nadu – Grasses
10. Materials for the Flora of Arunachal Pradesh, Vol. II (Asteraceae to Ceratophyllaceae)
11. Materials for the Flora of Arunachal Pradesh, Vol III (Hydrocharitaceae to Poaceae)
12. Flowering Plants of India – Dicotyledons, Volume I

13. Annotated Checklist of Lichens of India, 2010
14. Bulletin of Botanical Survey of India, Volume 50

Apart from that, Scientist of BSI published more than sixty five research papers in different peer reviewed journals during the period.

#### Report of the Indian Botanical Liaison Officer, Royal Botanic Gardens, Kew, UK

- Indian Botanical Liaison Officer identified twenty two species for the botanists of India. The images of the type sheet of forty nine taxa and eighteen protologues are provided to different institutes in India.

#### Digitization & establishment of integrated network of BSI Libraries and enrichment of library holdings

- Computerised catalogue of holdings of all BSI Libraries initiated using *e-granthalaya* software. The software is installed in computers of all libraries for electronic cataloguing to provide access to library database through internet
- Web portal of integrated network of BSI libraries made functional with digitization of all holdings of BSI, Southern Regional Centre, Coimbatore and ISIM, Kolkata.

#### Maintenance and enrichment of Herbaria in Botanical Survey of India

During the period nine hundred and forty six specimens have been mounted and remounted five thousand six hundred and eighty seven herbarium sheets. Nineteen thousand six hundred and forty five herbarium sheets have been dusted and fumigated. Twelve thousand three hundred and fifty nine herbarium sheets have been

poisoned and six thousand six hundred and eighty nine sheets have been incorporated in different herbaria of BSI.

#### Honours/Awards/Medals received

- Dr. H. C. Pande, Scientist, Northern Circle, Dehradun conferred with Prof. S. S. Bir Medal for significant contribution towards pteridology
- Director, BSI received the KOLTOLIC SHIELD on 04.09.2009 on behalf of BSI for the consecutive 3<sup>rd</sup> year for the best implementation of Official Language amongst the Central Government Offices in Kolkata.

#### Revenue earnings

During the period BSI earned a revenue of Rs. 25,36,321/- as per following breakings

- AJC Bose Indian Botanic Garden, Howrah, earned a revenue of Rs. 21,68,326/- through Entry Fee, Car Parking Fee, Cafeteria, Pavilion and through other fees
- Industrial Section Indian Museum, BSI, Kolkata earned a revenue of Rs.41,500/- through Identification of Plant Samples under N.D.P.S. Act
- Publication Section, BSI – Hqrs., Kolkata earned a revenue of Rs. 1,58,275/- and US\$ 104/- through sale of BSI publications
- Central National Herbarium, BSI, Howrah earned a revenue of Rs 14,650/- through identification of plants/samples received from Excise, Customs, Colleges
- Southern Regional Centre, Coimbatore, earned a revenue of Rs. 99,762/- through sale of BSI publications, Photocopying and Identification of Plant Samples

- Eastern Regional Centre, Shillong earned a revenue of Rs. 22,576/- through Identification, Sale of Plant Saplings, Training, Photocopying and Transit Charges
- Western Regional Centre, Pune, Northern Regional Centre, Dehradun and Arid Zone Regional Centre, Jodhpur earned a revenue of Rs. 12,690/-, Rs. 8,819/- and Rs. 9,723/- respectively through sale of BSI publications and Identification of Plant Samples

### Visit of Parliamentary Committees

The Parliamentary Committee on Official Language reviewed the status of implementation of official language in Arid Zone Regional Centre, Jodhpur on 10<sup>th</sup> February and in Central Regional Centre, Allahabad on 28<sup>th</sup> October, 2009.

### Visit of Planning Commission Member

Dr. K Kasturirangan, Hon'ble Member, Planning Commission, Government of India, visited the AJC Bose Indian Botanic Garden – Central National Herbarium Complex of Botanical Survey of India on September 17, 2009.

### Ph. D degree awarded/Ph.D thesis submitted

Eleven Ph.D theses have been submitted by the Research Scholars of BSI for award of degree, one of them has been awarded.

## Survey of Fauna

### Zoological Survey of India

#### Introduction and Objectives

The Zoological Survey of India (ZSI) a premier institute under the Ministry of

Environment and forests, has been undertaking exploration and research leading to the advancement of our knowledge on the exceptionally rich faunal diversity of the country since its inception in 1916, with its Headquarters at Kolkata and sixteen regional centres located in different parts of the country. In recent years, ZSI has reoriented its plan to work by grouping the survey and studies under six major programmes as follows: (i) Study of the fauna of states (ii) Fauna of conservation areas (iii) Fauna of important ecosystems (iv) Status survey of endangered species (v) Fauna of India and (vi) Ecological Studies & Environmental Impact Assessments (EIA). ZSI further provides (i) Identification & Advisory Services, (ii) Training & Extension Services in the field of animal taxonomy and faunistic surveys, (iii) Library facilities and (iv) Presentation & Publication of Research work in journals and books, (v) Maintenance of Museums at headquarters and regional centre at Digha and Chennai. Recently, ZSI also concentrates in i) Development of ENVIS on Faunal diversity, CITES centres and AICOPTAX Programmes, (ii) Chromosomal Mapping, DNA finger printing, Trichotaxonomic and Acoustic studies and (iii) Participation in Antarctica Expedition: ZSI is providing monthly e-News since January 2009, highlighting new discoveries, new records, published paper articles on its role in environmental protection, visit of the dignitaries, publication of checklists etc.

#### Activities undertaken during the year

During the year, scientists of the department discovered thirty nine species new to science, eight Senior Research Fellows (SRFs) obtained Ph.D. degree from different universities. ZSI recognized as the



repository of Zoological specimens by MoEF under Biological Diversity Act, 2002. Andaman and Nicobar Regional Centre have been recognized as lead institute under UNESCO. Planning Commission recognized the importance of Taxonomy and recommended ZSI to be the Centre of Excellence in Animal Taxonomy. Under Right to Information Act, 2005, ZSI handled twenty two cases. In this year Identification of thirty two seized materials of Wildlife authorities were carried out. A total of seven collaborative research projects of ZSI include habitat analysis for translocation of Pygmy hog at Jaldapara Wildlife Sanctuary was undertaken.

### Faunal Exploration and Surveys

#### – Ecosystems

A total of thirty eight extensive surveys were undertaken during this year viz. Mountain (nineteen), Forests (two), Marine (two), Estuarine (nine), Desert (four), Manmade ecosystems (two).

#### – Protected Areas

A total of nine extensive surveys were undertaken during this year viz. Gulf of Mannar, Sunderbans, Nokrek (Biosphere Reserve), Kumbhalgarh, Dalma, Radhanagiri, Kanyakumary (Wildlife Sanctuary), Mahatma Gandhi Marine National Park and Keibul Lamjao (National Park).

#### – Status Survey of Endangered Species

Status survey on the six species were undertaken viz., Swamp Deer, Mouse Deer, Goral, Chinkara, Desert Cat, Gangetic Dolphin, Blackbuck and Four horned antelope.

#### – State Faunal Surveys

A total sixteen and intensive surveys were undertaken in the states and Union Territories of viz., Arunachal Pradesh, Meghalaya, Assam, Uttar Pradesh, Uttarakhand, Haryana, Rajasthan, Bihar, Chhattisgarh, Madhya Pradesh, Orissa Jharkhand, Kerala, Karnataka, Maharashtra, Gujarat, Andaman and Nicobar Islands and Himachal Pradesh.

#### – Other Studies

A total of fourteen programmes under Ecological Studies, River Systems, Agro-ecosystems, Bioacoustics, and Eastern Ghats were under taken. Several scientists from Headquarters as well as Regional Centres observed the longest solar eclipse of the 21<sup>st</sup> century on 22<sup>nd</sup> July and in connection with that the scientists of the Survey conducted eco-observation studies on the impact of the eclipse on fauna.

#### – Environmental Impact Assessment (EIA) Studies

EIA studies were conducted in two areas, one at Kapudi and Jalipa Lignite Mining blocks of District Barmer, Rajasthan and Lower Subansiri Hydro-Electric Project.



Fig-5. Himalaya blue sheep popularly known as 'Bharal'

## Research Work

### – Identification of New Taxa

A total of thirty nine species were described new to science including one new genus during the year, the details are as follows:

#### Amphibia (Eleven)

Family: BUFONIDAE

*Bufo kiphirensis*  
*Bufo mamitensis*  
*Bufo manipurensis*  
*Bufo mizoramensis*  
*Bufo nagalandensis*  
*Bufo wokhaensis*

Family: RACHOPHORIDAE

*Chirixalus senapatiensis*  
*Philautus manipurensis*  
*Polypedates assamensis*  
*Polypedates subansiriensis*  
*Rhacophorus subansiriensis*

#### Pices (One)

Subfamily : NEMACHEILINAE

*Aborichthys rosammai*

#### Archnida (One)

Family: EREMULIDAE

*Eremulus indicus*

#### Insecta (Sixteen)

Order: HYMENOPTERA

*Narendraniola flagellate* n. gen., n.sp.  
*Tiphodytes gracilis*  
*Tiphodytes minutus*  
*Tiphodytes crassus*  
*Tanaodytes elongatus*  
*Heydenia gibsoni*  
*Philimides indicus*  
*Lophomyrmex changlangensis*

*Palachia frontopuncta*  
*Palachia neorobusta*  
*Palmon kottiyooricus*  
*Kostijurixia laharaensis*  
*Colotrechnus melghaticus*  
*Homoporus maharashtriensis*  
*Chlorocyclus amaravathicus*

Order : COLEOPTERA

*Corticarina mizoramica*

#### Nematoda (Ten)

Order : DORYLAIMIDA

*Torumanawa shinensis*  
*Myiodiscus mognus*  
*Neoactinolaimus rajasthanensis*

Order: SPIRURIDA

*Diplotrriaena champawatensis*  
*Diplotrriaena zootherae*  
*Diplotrriaenaniltavae*  
*Diplotrriaena almoraensis*

Order: MONONCHIDA

*Miconchus rectengularis*  
*Miconchus bulbicaudatus*  
*Cosmocercoides karnatakaensis*

#### New Records

Besides above, seventy species of Hard Corals, nineteen species of Budibranch Molluscs, seventy species of Pisces, twenty two species of Insects are new to the country and a number of the distributional records of States, Ecosystems and conservation areas.

#### – Taxonomic Studies

A total of fifteen thousand five hundred thirty two specimens including seven hundred eighty nine Aves (observed) and two hundred thirty four mammals (sighted)





Fig-6. Himalaya Griffon Vulture (*Gyps himalayensis*)

under eighteen faunal groups were collected, of which five hundred fifty eight species of twelve faunal groups.

#### – Checklist of Indian Fauna

Following checklist of Indian fauna are uploaded on the website viz., Nepomorpha (Hemiptera: Insecta), Gerromorpha (Hemiptera: Insecta), Atyidae and Palaemonidae (Decapoda: Crustacea), Lepidopterous Pests of Vegetables in India, Scelionidae (Hymenoptera: Insecta), Embioptera (Insecta), Odonata (Insecta), Pteromalidae (Chalcidoidea: Hymenoptera: Insecta), Acanthocephala, Eucharitidae (Hymenoptera: Chalcidoidea: Insecta), Amphibia, Chilopoda: Scolopendromorpha, Trichoptera (Insecta), Ephemeroptera (Insecta), Psychodidae (Diptera: Insecta), Valid Indian Rodent Taxa, Native freshwater Fishes of India, Membracidae (Homoptera: Insecta)

A Faunal database centre was inaugurated by Hon'ble Member of Planning Commission Prof. K. Kasturiranga.

#### – Collaborative Projects Undertaken

Six Collaborative Projects were assigned to ANRC, Andaman and Nicobar centre and one Collaborative research project of ZSI at Kolkata include Habitat analysis for translocation of Pygmy hog at Jaldapara Wildlife Sanctuary, West Bengal. Under the collaborative project, during this period eighteen field surveys were conducted in various islands of Campbell Bay in Great Nicobar Island, Mahatma Gandhi Marine National Park, North Bay Reef and Rutland in South Andaman, Ritchie's Archipelago in Middle Andaman and Nancowory Islands in Nicobar. As much as one thousand six hundred forty eight specimens collected through these surveys and nine hundred twelve faunal species were identified from the different groups. They are ninety six species of zooplankton, one hundred eighty three species of mollusks, ninety four species of echinoderms, one hundred sixty six species of corals, seventeen species of octocorals, ninety four species of fishes thirty four species of fishes, forty seven species of butterflies, eleven species of reptiles and amphibians, one hundred sixty five species of birds and five species of mammals.

#### – Identification and Advisory Services

During this period forty one enquiries pertaining to identification of different groups of animals were attended, from Universities and other agencies.

#### – Development of National Zoological Collection

The ZSI which is National depository of



Zoological specimens, maintaining the collection of a large number of identified examples of species belonging to almost all groups of animals of the country. The National Zoological Collection was further enriched by the addition of three thousand one hundred ninety eight identified specimens pertaining to five hundred fifty eight species.

#### – Training and Extension Programme

The following training courses were organised during the year.

- XII Leadership Course on “Environmental Awareness and Wildlife Conservation
- International Day for Biological Diversity “Invasive Alien Species” as the Focal theme
- Training Programme for “Non-matriculate Group-D Employees

#### – Departmental Publications

- Rec. ZSI Volume 109 (Part-1)
- Rec. ZSI Volume 109 (Part-2)
- Occ. Paper No. 292. Animal remains from Jaugada archeological site, Orissa... ancient civilization
- Occ. Paper No.293. Studies on little known Amphibian species of North East India
- Occ. Paper No. 294. Identification of some

small mammal species through owl pellet analysis

- Occ. Paper No. 295. Dung Beetles Thar desert of Gujarat
- Occ. Paper No. 296. Dung Beetles of Rajasthan
- Occ. Paper No. 297. List of valid rodent Taxa from Indian subcontinent
- Occ. Paper No. 298. A morphotaxonomic studies of the Indian species of *Forcipomyia* Meigen biting midges
- Occ. Paper No. 299. Bibliographical notes on Amphibians of N-E India
- Occ. Paper No. 300. Studies on the chromosomes of grasshoppers etc.
- Occ. Paper No. 301. Coral reef ecosystem of Andaman-Remote sensing and rapid site assessment survey



Fig-7. Greater Flamingo (*Phoenicopterus roseus*) in their natural habitat



## Ministry of Environment & Forests

- Occ. Paper No. 302. An annotated Checklist of Indian Amphibians
- Memoirs of ZSI Vol.21 (No.3). Animal remains from Brahmagiri Archeological site, Karnataka... Ancient civilization
- Pictorial Handbook – Dragonflies and Damselflies of Sunderbans
- Handbook on Butterflies of Himachal Pradesh
- Handbook on Hard Corals of Gulf of Kachchh
- Pictorial guide of fishes of Nemipteridae
- ENVIS Newsletter
- Animal Discoveries 2008
- Conservation Area Series 38- Tal Chhapar Wildlife Sanctuary
- Conservation Area Series 39- Pachmarhi Biosphere Reserve
- Conservation Area Series 40- Bandhavgarh Tiger Reserve
- Conservation Area Series 41- Simbalbara Wildlife Sanctuary
- Conservation Area Series 42- Bhimashankar Wildlife Sanctuary
- Fauna of Krishna Estuary

### – Books Released during the period

The following books were released during the year by the dignitaries-

- Animal remains from Brahmagiri archeological site, Karnataka... Ancient civilization by the Hon'ble Minister, MoEF.
- Fauna of Krishna Estuary by the Hon'ble Minister, MoEF

- Pachmarhi Biosphere Reserve by the Hon'ble Minister, MoEF
- Hard Corals of Gulf of Kachchh by the Hon'ble Minister, MoEF
- Bandhavgarh Tiger Reserve by the Member, Planning Commission, New Delhi
- Coral reef ecosystem of Andaman – Remote sensing and rapid site assessment survey by the Member, Planning Commission, New Delhi
- An annotated Checklist of Indian Amphibians by the Member, Planning Commission, New Delhi
- Catalogue of Type Species of Marine Porifera by the Member, Planning Commission, New Delhi
- Dung Beetles of Rajasthan by Prof. Madhav Gadgil, Chairman, Task Force, ZSI and BSI
- Tal Chhapar Wildlife Sanctuary by Prof. Madhav Gadgil, Chairman, Task Force, ZSI and BSI

### – Identification of Seized Specimens from the Enforcement Authorities

Twenty seven confiscated materials of Forest department/law enforcing directorates/ Police department were identified, and report sent to the concerned office. The status of the following schedule animals *Trochus niloticus*, *Turbo marmoratus* and Horseshoe crab *Carcinoscorpius rotundicanda* and *Carcinoscorpius gigas* were reviewed, in consultation with the IG Forests, MoEF. Animals included under Section 38 of Biodiversity Act received from different states are also reviewed.

– Foreign Visit

Four Scientist from ZSI has participated in “IUCN Eastern Himalayas Freshwater Biodiversity Assessment Training Workshop” at Kathmandu, Nepal from 22<sup>nd</sup> to 26<sup>th</sup> July, 2009.

– National Symposium

One national symposium “On recent advances in biodiversity” conducted by Andaman and Nicobar regional centre, ZSI, one hundred twenty five participants attended, sixty four oral presentations were made on this occasion. Volume containing one hundred twenty six abstracts has been released during the symposium.

– Golden Jubilee Celebrations

On completing fifty years of service to Nation, Northeast Regional Centre, the year long programme was initiated by Hon’ble Governor of Meghalaya with release of four books, a quiz programme in collaboration with Doordarshan Kendra, Shillong and a one day seminar on the Role of Media on conservation of Biological Diversity.

– Participation on Training Programme on Information Technology (IT) Awareness and E-Governance under Information Technology Programmes

Two hundred twenty three officer/staff of ZSI attended e-governance training programme under different batches at different locations.



Fig-8. Horse-shoe crabs, found in north-east coast of India need protection

– Participation in Exhibition

ZSI participated twelve exhibitions at different places of the country. Museums and Aquaria maintained by ZSI attracted a large number of public as well as students, Western Ghats ecosystem at Calicut and Marine animals at Chennai and Digha attracted maximum number of visitors viz. 4180, 2800 and 5,200 respectively.

– Biodiversity Board Meeting Attended

ZSI scientists attended various state Biodiversity board meetings at West Bengal, Karnataka, Mizoram, Orissa, Gujarat, and provided the information of Rules for amendments, their expertise in collection, preservation and identification of animals and their ecology, framing the modalities of awareness programmes towards conservation of biodiversity in respective state.

– Library Facility

ZSI library is holding the largest collection of Books Journals on Zoology in Asia. During this year two hundred sixty nine books were purchased and twenty five were received as gift from various Institutes. Journals purchased three hundred thirteen, by gift three hundred fifty four, and by exchange seven hundred ninety four. Library provided four thousand nine hundred twenty one pages photocopies to Scientists. Those who visited library were one thousand four hundred eighty nine (departmental) and six hundred fourteen from other Institutes and colleges. Comprehensive catalogues on the following animal groups viz., Mammals, Birds, Reptilia and Amphibia, Fish, Mollusca, and Helminthology have been submitted for publication. Data entry of Library holdings for e-Granthalaya commenced at Jodhpur, Pune, Dehradun and Chennai.

– Visitors to Zoological Survey of India

Eleven renowned specialist of Indian national and six Foreign National examined

type specimens and they were provided all necessary facilities.

**Forest Resources and Survey**

**Survey and Utilisation (SU) Division**

Survey & Utilization (SU) deals with the matter related to Forest Survey of India, Dehradun, Andaman & Nicobar Forest & Plantation Development Corporation Ltd., Port Blair, Export & Import of wood and wood products, Forest Certification, Sustainable Forest Management, International Tropical Timber Organization etc.

Beside the above there is a plan scheme in SU Division - 'Strengthening of Forestry Division' under its administrative control. This scheme have five component which are as follows:-

- Forest Survey of India
- Network of Regional Offices
- National Forestry Data Base Management System (NFDMS)/ National Forestry Information System
- Sustainable Forest Management, Certification, Trade etc./ Certification Programme for Wood and Non-wood Forest Resources
- National Coordinated Programme for Assessment of Non-Timber Forest Products Resources

**Forest Survey of India (FSI)**

**Introduction**

Forest Survey of India (FSI) is a national level organization for forest resource assessment of the country under the Ministry of Environment and Forests,



Fig-9. The painted grasshopper (*Poekilocerus pictus*)

Government of India. It succeeded the "Pre investment Survey of Forest Resources" (PISFR), which was a project initiated in 1965 by Government of India with the sponsorship of Food and Agriculture Organization (FAO) and United Nations Development Programme (UNDP). The PISFR was reorganized into FSI in June 1981. The mandate of FSI was revised in 1986 in order to make it more relevant to the rapidly changing needs and aspirations of the country. Major activities of FSI are Forest & Tree Cover Assessment and Estimation of Growing Stock of wood within and outside the country's forests. FSI is also engaged in providing training to state forest department personnel in application of Remote Sensing & Geographical Information System (GIS) in forest resource assessment. The main objectives of FSI are as.

- To assess the forest cover of the country through Remote Sensing technology, analyze the changes and prepare State of Forest Report biennially.
- To conduct inventory in forests and non-forest areas at national level and develop database on wood volume and also estimate tree cover.
- To function as a nodal agency for collection, compilation, storage and dissemination of spatial database on forest resources.
- To conduct training of forestry personnel in application of technologies related to resources survey, remote sensing, GIS, etc.
- To strengthen research & development infrastructure in FSI and to conduct research on applied forest survey techniques.
- To support State/UT Forest Departments (SFD) in forest resources survey, mapping and inventory.

- To undertake forestry related special studies/consultancies and custom made training courses for SFD's and other organisations on project basis.

### Organizational Set-up

The Forest Survey of India is located at Dehradun and its four zonal offices are located at Shimla, Kolkata, Nagpur and Bangalore. The organisation is headed by a Director General, assisted by two Joint Directors at the headquarters who are looking after the National Forest Data Management Centre (NFDMC) and the Training & Forest Inventory (TFI) wings and eight Deputy Directors, Assistant Directors and other technical & ministerial staff. Each zonal office is headed by a Regional Director supported by Deputy Director(s) and other technical & ministerial staff. The Headquarters as well as the zonal offices work in close coordination to carry out the various mandated and additional activities of FSI.

Besides administration and overall control, the activities at the headquarters includes forest cover assessment, producing maps, designing methodology for national inventory, data processing, producing State of Forest Reports, conducting training, coordination and monitoring the activities of Zonal offices. The major activity of the zonal offices is field inventory. In a phased manner the zonal offices are also being assigned the work of forest cover mapping.

The Forest Survey of India, with its four regional centres has continued the mandated activities of this organisation viz. assessment of the forest cover on a two-year cycle and publishing the findings in the India State of Forest Report; Inventory of forest and trees outside forest; imparting training to

forestry personnel in the field of application of Remote Sensing/GIS/GPS in forest resource assessment; conducting special studies and other R&D works.

### Forest & Tree Cover

With the release of the 'India State of Forest Report 2009' so far eleven cycles of forest cover assessment have been completed since 1987. Over the year with the advancement of technologies of image processing and data quality of remote sensing, the methodology of forest cover assessment has improved to provide more accurate data products for better operational management and planning. In addition to forest cover, assessment of tree cover of the country is also being carried out using the Tree Outside Forest (TOF) inventory data.

### Forest & TOF inventory



More than 80 % forest area of the country was inventoried by 2000. A new inventory design was adopted by FSI since 2002 to generate national level estimates of growing stock both for forest and TOF resources on a two year cycle on the basis of selected sampled districts. This estimate is further improved in the subsequent cycle with the increase in the numbers of sampled districts. Thus there is a progressive improvement in the precision of the estimates with completion of each cycle.

### Training

More than two thousand nine hundred forestry personnel from State Forest Departments have been trained so far in the various training programmes conducted at FSI on the following themes.

- Application of Remote Sensing and GIS in Effective Forest Planning and Management
- Application of Remote Sensing and GIS in Working Plan Preparation
- Advanced Course on Application of GIS in Forest Resource Management
- Inventory Techniques, Image Processing and GIS Applications in Forestry
- GPS in Forest Surveys & Demarcation

FSI has also trained around five hundred forestry personnel at various outreach customized training courses for the State Forest Departments.

In addition to the above, FSI is also working on various projects assigned by Government of India some of which are as follows.

- National Forest Type Mapping
- Monitoring of Area Coverage & Survival Percentage of Plantations/ Afforestation under National Afforestation Programme (NAP)
- Mapping of change in land use in Aravalli hills of Haryana
- Assessment of Coral Reefs in India
- Near real time monitoring of active Forest Fires using MODIS Web Fire Mapper
- Analysis of eligibility of lands for afforestation and re-afforestation projects under Clean Development Mechanism (CDM)
- Assessment of Mangroves in India
- Coastal Zone Studies project

### India State of Forest Report 2009

#### Introduction

Forest Survey of India has been bringing out 'State of Forest Reports' since

1987 based on interpretation of satellite images.

India State of Forest Report 2009 is the eleventh such report.

Forest cover mapping in this report has been done by digital interpretation of satellite images of LISS III sensor of Resourcesat-1. The scale is 1:50,000 and the minimum mappable area is 1 ha.

### Forest Cover

The status of forest cover of the country based on digital interpretation of satellite data of the period Oct 2006-Feb 2007 having spatial resolution of 23.5m is provided in the Table-1.

India's forest cover in 2007 is 69.09 million ha which is 21.02% of the geographical area. Of this, 8.35 million ha (2.54%) is very dense forest, 31.90 million ha (9.71%) is moderately dense forest, and the rest 28.84 million ha (8.77%) is open forest; including 0.46 million ha mangroves. Excluding the area (18.31 million ha) above tree line, the forest cover of the country comes of 22.26%.

A comparison of the forest cover of the country between the present and the preceding assessments (2005) shows that there is a net gain of 728 km<sup>2</sup> during the period.

Due to a new methodology, refinement has been done in the forest cover data of 'SFR 2005'. The original and revised figures of 'SFR 2005' have been presented in Chapter 1 of the main report.

Madhya Pradesh has the largest forest cover (7.77 million ha) amongst States/UTs constituting 11.25% of the country's forest

cover followed by Arunachal Pradesh (9.75%), Chhattisgarh (8.09%), Maharashtra (7.33%) and Orissa (7.07%).

The seven North-East States together account for about one fourth of the total forest cover of the country. The North-East region of the country comprising seven States namely, Arunachal Pradesh, Assam, Manipur, Meghalaya, Mizoram, Nagaland & Tripura is only 7.76% of the geographic area of the country, but accounts for nearly one fourth of its forest cover. The total forest cover in the region is 170,423 km<sup>2</sup>, which is 66.81% of the geographic area as against the national average of 21.02%. Compared with the previous assessment, there is a net gain of 598 km<sup>2</sup>.

### Decadal Change in Forest Cover of the Country

Forest cover of India has shown an increasing trend in the last decade despite the ever increasing pressure on forests due to population growth. The increase in the forest cover of the country is reflected in the time series of forest cover assessments done by FSI on a biennial basis since 1987. As seen the forest cover of India has increased from 65.96 million ha in 1997 assessment (satellite data pertaining to 1994) to 69.09 million ha in the current assessment (satellite data pertaining to 2009-07) i.e. an increase of 3.13 million ha (4.75%). It is worth noting here that because of significant changes in the resolution and quality of satellite data, methodology of interpretation, scale of mapping and classification scheme, the decadal data may not be strictly comparable. An attempt has been made to reduce (normalize) the effects of

## Ministry of Environment & Forests

**Table-1.** Forest cover in States/UTs in India in 2007

States/UTs	Geographical Area (GA)	Forest Cover				Percent to GA	Change in forest cover	Scrub
		Very Dense Forest	Mod. Dense Forest	Open Forest	Total			
Andhra Pradesh	275,069	820	24,757	19,525	45,102	16.40	-129	10,372
Arunachal Pradesh	83,743	20,858	31,556	14,939	67,353	80.43	-119	111
Assam	78,438	1,461	11,558	14,673	27,692	35.30	-66	179
Bihar	94163	231	3248	3325	6,804	7.23	-3	134
Chhattisgarh	135,191	4,162	35,038	16,670	55,870	41.33	-59	107
Delhi	1,483	7	50	120	177	11.94	0	1
Goa	3,702	511	624	1,016	2,151	58.10	-5	1
Gujarat	196022	376	5249	8995	14,620	7.46	16	1,463
Haryana	44212	27	463	1104	1,594	3.61	-10	145
Himachal Pradesh	55673	3224	6383	5061	14,668	26.35	2	327
Jammu & Kashmir	222,236	4,298	8,977	9,411	22,686	10.21	-3	2,036
Jharkhand	79714	2590	9899	10405	22,894	28.72	172	683
Karnataka	191,791	1,777	20,181	14,232	36,190	18.87	-10	3,176
Kerala	38,863	1,443	9,410	6,471	17,324	44.58	40	58
Madhya Pradesh	308,245	6,647	35,007	36,046	77,700	25.21	-39	6,401
Maharashtra	307,713	8,739	20,834	21,077	50,650	16.46	-11	4,157
Manipur	22,327	701	5,474	11,105	17,280	77.40	328	1
Meghalaya	22,429	410	9,501	7,410	17,321	77.23	116	211
Mizoram	21,081	134	6,251	12,855	19,240	91.27	640	1
Nagaland	16,579	1,274	4,897	7,293	13,464	81.21	-201	2
Orissa	155,707	7,073	21,394	20,388	48,855	31.38	100	4,852
Punjab	50362	0	733	931	1,664	3.30	4	20
Rajasthan	342,239	72	4,450	11,514	16,036	4.69	24	4,347
Sikkim	7,096	500	2,161	696	3,357	47.31	0	356
Tamil Nadu	130,058	2,926	10,216	10,196	23,338	17.94	24	1,206
Tripura	10,486	111	4,770	3,192	8,073	76.99	-100	75
Uttar Pradesh	240,928	1,626	4,563	8,152	14,341	5.95	-5	745
Uttarakhand	53,483	4,762	14,165	5,568	24,495	45.80	2	271
West Bengal	88,752	2,987	4,644	5,363	12,994	14.64	24	29
Andaman & Nicobar	8,249	3,762	2,405	495	6,662	80.76	-1	53
Chandigarh	114	1	10	6	17	14.91	0	1
Dadra & Nagar Haveli	491	0	114	97	211	42.97	-5	1
Daman & Diu	112	0	1	5	6	5.04	0	3
Lakshadweep	32	0	16	10	26	82.75	0	0
Puducherry	480	0	13	31	44	9.14	2	0
<b>Grand Total</b>	<b>3,287,263</b>	<b>83,510</b>	<b>319,012</b>	<b>288,377</b>	<b>690,899</b>	<b>21.02</b>	<b>728</b>	<b>41,525</b>

\*The change in the above table refers to change in the area with respect to revised assessment for 2005.



methodology and technology changes, so that an estimate of the real change in the forest cover can be elicited, although such an exercise is bound to have its own limitations and the results can be only taken as best approximations.

The technological advancement and methodological refinements over the years as mentioned above have resulted in three significant changes viz. change of scale, inclusion of smaller patches of forest cover up to one ha and switching over from raster to vector approach. However, by suitable mathematical treatment using a logical basis, an effort has been made to make the assessment results of different years comparable by factoring in these changes

### Forest cover in different forest types

An extensive study was carried out in GIS frame work to map India's forests by forest types according to Champion & Seth classification (1968) on 1:50,000 scale. There are sixteen forest type groups sub divided into two hundred types. In India SFR 2009 this information is being presented up to sixteen type groups.

### Forest cover in different altitude zones

The forest cover data was analyzed in GIS format to determine the forest cover in different altitudinal zones for the first time. The zones for analysis were taken as 0 - 500m, 500-1000m, 1000-2000m, 2000 - 3000m and above 3000m.

Considering area above 4000m ('tree line') as not suitable for increasing forest cover for all practical purposes, the area in the Himalayan region of the country in the states

of Arunachal Pradesh, Himachal Pradesh, Jammu & Kashmir, Sikkim and Uttarakhand was assessed (183, 135 km<sup>2</sup>). If this area is removed, the forest and tree cover of the country becomes 25.25% of the geographical area.

### State-wise growing stock

India SFR 2009 provides estimates of State-wise growing stock. The methodology of National Forest Inventory (NFI) is designed to provide estimates of growing stock at national level. In the national level inventory design, the distribution of sample plots is not adequate to generate the state level estimates directly. However, considering the requirement of state level estimates of growing stock, a special technique has been applied for the first time, for generating the state level estimates.

### Forest cover in hill districts

As per the planning Commission's criterion, a hill taluka is one with altitude over five hundred metre from the mean sea level. A hill district is one with over half its area under hill talukas. The forest cover in one hundred twenty four hill districts is 281,841 km<sup>2</sup>, which is 39.82% of the total geographic area of these districts, showing a net gain of 663 km<sup>2</sup>, mainly due to regrowth in shifting cultivation areas.

From another perspective, the tribal districts have nearly three fifths of the country's total forest cover.

### Forest cover in tribal districts

FSI has assessed forest cover in the districts identified as tribal districts by the



Government of India in the Integrated Tribal Development Programme. The forest cover in 188 tribal districts is 412,625 km<sup>2</sup>, which is 37.32% of the total geographic area of these districts, showing a net gain of 690 km<sup>2</sup> which is mainly due to regrowth in shifting cultivation area and protection.

### Mangrove cover

Mangroves comprise salt-tolerant, evergreen, broad leaved trees having aerial roots like pneumatophores or stilt roots and viviparous germinated seedlings found mainly in tropical and subtropical inter-tidal regions of the world.

Mangroves in India cover 4,639 km<sup>2</sup> showing a net increase of 58 km<sup>2</sup> over the previous assessment figures. West Bengal has nearly half of the country's mangroves.

### Tree cover

India's tree cover (comprising sub hectare tree patches outside forest cover) has been estimated as 92,769 km<sup>2</sup> (Table-2) constituting 2.82% of geographical area of the country. Excluding the area above tree line, it comes to 2.99%.

Tree cover constitutes the largest area in Maharashtra (9,466 km<sup>2</sup>) followed by Gujarat (8,390 km<sup>2</sup>), Rajasthan (8,274 km<sup>2</sup>) and Uttar Pradesh (7,381 km<sup>2</sup>). Considering the percentage of geographic area under tree cover, the highest rank goes to Lakshadweep (12.50%) followed by Chandigarh (9.65%), Delhi (8.29%), Daman & Diu (8.04%), Goa (7.73%) and Kerala (7.21%).

The total growing stock of wood in the country has been estimated to be 6.098 billion

m<sup>3</sup> of which 4.499 billion m<sup>3</sup> is in the forests, and 1.599 billion m<sup>3</sup> is in tree outside forests.

The average growing stock (in forests) is 58.46 m<sup>3</sup> per ha.

### Network of Regional Offices

Six Regional Offices have been set up at Bangalore, Bhopal, Bhubaneswar, Lucknow, Shillong and Chandigarh, with the Headquarter unit in the Ministry at New Delhi to carry out the following roles and functions (Objectives):

- To monitor and evaluate all ongoing forestry development projects and scheme with specific emphasis on conservation of forests;
- To assist the State/UT Governments in preparation of the proposals involving diversion of forests land for non-forestry purposes under the provisions of Forest(Conservation) Act, 1980;
- To undertake physical inspection of site in cases of diversion of forestland involving an area of more than forty ha.
- To monitor the implementation of conditions and safeguards stipulated by Central Government in the proposal approved under Forest (Conservation) Act, 1980.
- To assist the State/UTs in the preparation of management plans for working of forest under their control within the framework of guidelines issued by Central Government from time to time;
- To assist the State/UTs in streamlining collection, collation, storage and retrieval of data/ covering all forestry activities and to transmit such data to the Central Government/ Central Data Processing Unit.

Table-2. State/ UT wise Tree Cover Estimates

S.N	State/UT	Geographic Area	Tree Cover	
			Area (km <sup>2</sup> )	% of Geo. Area
1	Andhra Pradesh	275,069	7,191	2.61
2	Arunachal Pradesh	83,743	592	0.71
3	Assam	78,438	1,590	2.03
4	Bihar	94,163	2,495	2.65
5	Chhattisgarh	135,191	4,027	2.98
6	Delhi	1,483	123	8.29
7	Goa	3,702	286	7.73
8	Gujarat	196,022	8,390	4.28
9	Haryana	44,212	1,409	3.19
10	Himachal Pradesh	55,673	638	1.15
11	Jammu & Kashmir	222,236	6,764	3.04
12	Jharkhand	79,714	3,032	3.80
13	Karnataka	191,791	5,683	2.96
14	Kerala	38,863	2,801	7.21
15	Madhya Pradesh	308,245	6,871	2.23
16	Maharashtra	307,713	9,466	3.08
17	Manipur	22,327	197	0.88
18	Meghalaya	22,429	542	2.42
19	Mizoram	21,081	172	0.82
20	Nagaland	16,579	300	1.81
21	Orissa	155,707	4,435	2.85
22	Punjab	50,362	1,699	3.37
23	Rajasthan	342,239	8,274	2.42
24	Sikkim	7,096	20	0.28
25	Tamil Nadu	130,058	4,968	3.82
26	Tripura	10,486	171	1.63
27	Uttar Pradesh	240,928	7,381	3.06
28	Uttarakhand	53,483	665	1.24
29	West Bengal	88,752	2,458	2.77
30	Andaman & Nicobar Islands	8,249	44	0.53
31	Chandigarh	114	11	9.65
32	Dadra & Nagar Haveli	491	27	5.50
33	Daman & Diu	112	9	8.04
34	Lakshadweep	32	4	12.50
35	Pondicherry	480	34	7.08
	<b>Total</b>	<b>3,287,263</b>	<b>92,769</b>	<b>2.82</b>

- To dispose of proposal for diversion of forestland up five ha. & to examine / process the proposal above five ha to forty ha; except regularization of encroachment and mining.
- To render assistance in preparation of the National Forestry Action Plan.
- To assist Paryavaran Vahinies in the capacity of observers as well as technical advisors;
- To monitor implementation of conditions and safeguards laid down by the Ministry for Environmental clearance under EPA 1986.

The Headquarter Unit in the Ministry at New Delhi is responsible for administration, supervision and co-ordination of all the activities relating to the function assigned to the Regional Offices as enumerated above under the overall control of the Ministry of Environment & Forests.

### 'Forest Certification' of Timber, Non-Timber Forest Products

- Forest Certification has emerged as a voluntary market-driven mechanism in support of Sustainable Forest Management (SFM). Certification initiatives rely on consumers exercising purchasing choice in favour of products labelled as originating from forests certified to have been sustainably managed. Certification and Eco-labeling are the new mantras to enhance the product positioning for a premium price on one hand and ensuring better forest management practices on the other hand.
- The Ministry constituted a National Working Group / Governing Body to frame the

policy guidelines for forest certification for timber and Non-timber forest products. For this purpose, three Committees were constituted to prepare a road map and the necessary criteria and processes for the development of National Certification mechanism in the country. These committees were merged into single committee namely the '*National Forest Certification Committee*' for the development of Certification Criteria, Certification Process and Accreditation Criteria & Process towards Forest Certification of timber, Non-timber Forest Products under the Chairmanship of Prof. Maharaj Muthoo, Ex-Executive Director, FSC with the approval of Hon'ble MOS (F&WL).

- In this year, three meeting of the National Forest Certification Committee was convened on 15<sup>th</sup> April, 2009, 3<sup>rd</sup> July, 2009 and 25<sup>th</sup> August, 2009. These meetings were attended by a large number of stakeholders from different parts of country and abroad. In these meetings, it was unanimously agreed that the committee should continue to work with due diligence towards assessing the modus operandi for instituting an appropriate Forest Certification Mechanism in the country. This should be expedited so that an independent National Certification Council is established as possible with a secure corpus fund within an year or so.

### Development of National Forestry Database Management System (NFDMS)

- The Ministry constituted an Expert/ Advisory/ Working Group with an aim to

support the implementation of an integrated National Forestry Database Management System (NFDMS) in a comprehensive manner including strengthening of the technological, institutional and human capabilities to ensure continuing and effective dissemination and use of forest statistics. In this year, the Ministry has funded a National Preparatory Workshop for Forestry Information System which will be conducted by Centre for Forest and Natural Resource Management Studies, Government of Andhra Pradesh in Hyderabad.

#### National Coordinated Programme for Assessment of Non-Timber Forest Products Resources

– A Committee was constituted under the Chairmanship of Inspector General of Forests (NAEB), Ministry of Environment & Forests for evolving a mechanism for Minimum Support Price to the collectors of Non-Timber Forest Products (NTFP's). After due deliberations & consultations with stakeholders involved in NTFP's sector, the committee has submitted a report identifying the issues and future course of action. In the report, it has been proposed that for overall coordination of issues relating to NTFP, a national body should be constituted which, apart from policy and programmatic initiatives may provide financial resources for the management and development of the NTFP sector. An apex level body set up at the national level would help and guide the NTFP sector through the critical phase that it is passing through.

The Ministry had circulated the report to concerned stakeholders and a meeting was

convened on 24<sup>th</sup> July, 2009. In this meeting, it was decided that FRI, Dehradun will send a study proposal to address the issue of 'Ensuring Fair Returns to Primary Collectors of Non Timber Forest Products'. Accordingly, a proposal was received from FRI, Dehradun which is under examination.

#### Export & Import of forestry products and Tariff structure forestry items

– The Division deals with the formulation of guidelines and directions for domestic and international trade in forest produce and the necessary regulation of export and import of forest produce as per the Foreign Trade Policy as well as the applied Tariff rates. Towards this purpose, the Ministry has constituted a Core Group to study the applied rates and import duties which are very significant in deciding the tariff rates for multilateral and bilateral trade negotiations. The Core Group has recommended that certain items under ITC (HS) classification to be removed from the Negative List for the purpose of import and retained a few items under the sensitive (Negative List) necessary to safeguard the interest of farmers of agro-forestry and farm-forestry in particular and the overall health of the Forestry Sector in general. Moreover, the decisions regarding the tariff structure are being taken in view of the country specific bilateral/multilateral trade negotiations keeping the environmental and ecological sensitivity of the items under the ITC (HS) Codes on top priority.

The Division also deals with the issue of NOC for grant of export license for export of wood and wood products for the

application received through Directorate General of Foreign Trade, New Delhi.

### International Tropical Timber Organisation (ITTO)

– The International Tropical Timber Organisation (ITTO) was established during 1983 and is governed by the International Tropical Timber Agreement (ITTA). The ITTO is a commodity organisation bringing together the producer and consumer member countries to discuss and exchange information and develop policies of all aspects of the World Tropical Timber Economy. The Headquarter of ITTO is at Yokohama, Japan. There are fifty nine member countries, out of which thirty three are Producer member countries and twenty six Consumer member countries. India belongs to the group of the producing member countries. The ITTO's membership represents 90% of world trade in tropical timber and 80% of the world's tropical forests.

– The ITTO members in 1990 agreed to strive for International Trade of Tropical Timber from sustainably managed forests by the century's end. This commitment became known as the 'Objective 2000' and a large part of the ITTO programme of projects and activities are devoted to its achievement. It remains a central goal of the Organisation, supported by renewed efforts to raise the capacity of government, industry and communities to manage their forests and add value to their forest products, and to maintain and increase the transparency of the trade and access to international markets.

– The International Tropical Timber Agreement (ITTA), 1994 is being

replaced by a successor agreement, i.e. the ITTA 2006. India as a signatory to ITTA 1994 has ratified and deposited the instrument of ratification with the UN Secretary General in New York on 25<sup>th</sup> July, 2008.

### International Tropical Timber Council (ITTC)

– The governing body of the ITTO is the International Tropical Timber Council, which is composed of all the organization's members. The council is supported by four Committees namely:-

- Committee on Economic Information and Market Intelligence
- Committee on Reforestation and Forest Management
- Committee on Forest Industry
- Committee on Finance and Administration

– The 45<sup>th</sup> session of the International Tropical Timber Council (ITTC), the governing body of ITTO was held at Yokohama, Japan during 9<sup>th</sup> - 14<sup>th</sup> November, 2009 and was attended by Deputy Inspector General of Forests as Indian delegate.

### Sustainable Forest Management (SFM) Cell

– Sustainable Forest Management of Forests is of immense significance due to its contribution towards sustainable development. Sustainable Management of Forest is not a new concept in India. India remains committed to the goals of Sustainable Forest Management and is a signatory to the "Objective 2000" of the ITTO.

Committed to the goal of achieving Sustainable Forest Management a National Task Force was constituted in November, 1999 by Government of India non as Bhopal-India process this recognized eight Criteria and forty three Indicators. The National set of C&I was refined in the year 2005 based on field experiences. Thereafter eight Criteria and thirty seven Indicators have been adopted during the year 2008 for monitoring the directions of change at National level. These are suitable to all forest types and situation within the country and specifically designed for implementation and monitoring at local Forest Management Unit (FMUs).

In pursuance towards achieving sustainable forest management in the country, the following actions have been undertaken by the Government:-

- An SFM Cell has been constituted in the Ministry of Environment & Forests, Government of India. This would act as Nodal Body for policy matter at the Central level.
- An SFM Cell has also been created in all the State Forest Departments on the similar lines of Central level 'SFM Cell' headed by Working Plan in the respective States / UTs.
- As per the decision taken in the second meeting of SFM Cell in the Ministry, in which all the members of the SFM Cell and the representatives from various State Forest Departments participated. The following four teams had been constituted:-
  - Team under the chairmanship of Ex-DG (Forests) to prepare a document namely

*"Revised Working Plan Code"* for incorporating the final draft Criteria & Indicator for Sustainable Forest Management into the Working Plan Code.

- Two teams have been constituted under the chairmanship of Ex-DG (Forests) and Ex-PCCF, Madhya Pradesh respectively for the *Pilot Testing* of the final draft *Criteria & Indicator (C&I)* in the field for Northern, Central, Eastern, Western and Southern Regions.
- A team has been constituted under the chairmanship of Ex-PCCF, Madhya Pradesh for the purpose of preparation of Criteria & Indicator (C&I) for Sustainable Management of Plantation in India.
- A team has been constituted under the chairmanship of Ex-PCCF, Madhya Pradesh for the purpose of Development of Criteria & Indicator (C&I) for Sustainable Management of Non-timber Forest Products (NTFPs)
- The 1<sup>st</sup> meeting of team to prepare a document namely *"Revised Working Plan Code"* for incorporating the final draft Criteria & Indicator for Sustainable Forest Management into the Working Plan Code was held on 18<sup>th</sup> August, 2008 at Delhi under the Chairmanship of Ex-DG (Forests). A combined meeting of two teams for the *Pilot Testing* of the final draft *Criteria & Indicator (C&I)* in the field for Northern, Central, Eastern, Western and Southern Regions was also held on 19<sup>th</sup> August, 2008 at Delhi. A project on Pilot Testing of the final draft of the



National C&I has now be sanctioned by the Ministry.

- The Ministry has sanctioned the following project to Indian Institute of Forest Management, Bhopal:-
  - Preparation of Criteria & Indicators for Sustainable Forest Management of Plantation in India
  - Pilot Testing of the National Set of Criteria & Indicators for Sustainable Forest Management (SFM) in India.
  - Development of Criteria & Indicators for Sustainable Management of Non-Timber Forest Produce (NTFP)

In addition to the above, another project was sanctioned to Forest Research Institute, Dehradun regarding revision of National Working Plan Code. Projects on estimation of Biomass, Role of wood carving, bamboo etc. have also been sanctioned to FRI, Dehradun.

### **Andaman & Nicobar Islands Forest and Plantation Development Corporation Ltd.**



Andaman & Nicobar Islands Forest and Plantation Development Corporation Limited (ANIFPDCL) is a Government of India Public Sector Undertaking, created in 1977 with the broad objectives of development and managing forestry plantations on the Islands. This Corporation has three main activities namely (i) Forestry Project, (ii) Red Oil Palm (ROP) and (iii) Katchal Rubber Project (KRP) in operation.

It is loss making undertaking mainly due to the fact that its main activity i.e. logging,

has been curtailed by the Hon'ble Supreme Court's Order banning the felling of trees. Due to this, even the obligatory expenses of the Corporation like the payment of salaries, wages etc. are possible only due to the sanction of interest bearing loans every year from the Government of India. During the year 2009-10, an amount of Rs.10.45 crore has been sanctioned and released to ANIFPDCL as an interest bearing loan for making payment of salaries, wages, etc. Therefore, the restructuring of the Corporation in order to make it financially viable has become a necessity. A proposal has been submitted by the Managing Director, ANIFPDCL regarding restructuring of the Corporation by offering Voluntary Retiring Scheme (VRS) to its employees and closure of loss making units. After due examination, a committee under the Chairmanship of the PCCF and Secretary (Forests), Andaman & Nicobar Islands was constituted to look into matter and submit a self contained proposal regarding the revival of the Corporation. The said report (Choudhury Committee Report) has been received in the Ministry with the comments from A&N Administration in December, 2009. A meeting is scheduled in February/March, 2010 under the Chairmanship of Secretary (E&F) to discuss the recommendations received from A&N Administration for the revival and restructuring of ANIFPDCL. A preliminary discussion was held under the Chairmanship of DGF&SS on the recommendations of Choudhury Committee Report on 22<sup>nd</sup> February, 2010. As soon as the meeting will take place under the Chairmanship of Secretary (E&F), a draft Cabinet Note will be prepared and submitted to the Union Cabinet thereafter.



A large herd of sheep, including white, black, and brown varieties, is grazing on a steep, rocky mountain slope. The sheep are scattered across the terrain, which is covered with patches of green grass and shrubs. In the background, a large, dark, craggy rock formation rises against a pale sky. A semi-transparent, rounded rectangular box is overlaid on the upper part of the image, containing the chapter title.

## **CHAPTER – 2**

# **CONSERVATION**

## Environmental Conservation

### Introduction and Objectives

The Ministry of Environment & Forests is at the forefront in regard to conservation and management of mangroves & coral reefs. The Ministry accords high priority to the Conservation and Management of Mangroves and Coral Reefs in the country. The Coastal Regulation Zone Notification (1991) under the Environmental Protection Act (1986) recognizes the mangrove and coral reefs areas as ecologically sensitive and categorizes them as CRZ-I (i) which implies that these areas are afforded protection of the highest order. Under the promotional measures, the Government has identified thirty eight mangrove areas and four coral reefs areas on a country-wide basis for intensive conservation and management. (Table-3)

### The National Environment Policy and the Scheme



The National Policy, 2006 recognizes that mangroves and coral reefs are an important coastal environmental resource. They provide habitats for marine species; protection from extreme weather events; and a resource base for sustainable tourism. The National Environment Policy underlines the need to mainstream the sustainable management of mangroves into the forestry sector regulatory regime and adopt a comprehensive approach to Integrated Coastal Zone Management.

### Mangroves

As per the State of Forest Report 2009, published by Forest Survey of India the mangrove cover in the country is 4,639 sq km which is 0.14% of the country's total

geographical area (Table-4). Compared with 2005 assessment, there has been an increase of fifty eight sq km in mangrove cover mainly because of the plantations and protection measures in the States of Gujarat, Orissa, Tamil Nadu and West Bengal. Decrease in mangrove cover in Andamans & Nicobar Islands is attributed to after effects of tsunami.

Mangroves play an important role in coastal ecology and protecting the coastal areas from the impact of tidal waves but the extent of protection is variable & is a function of several factors.

In case of Mangroves, the objectives of the Scheme is to help the Coastal State Governments/Union Territories in rehabilitation of degraded Mangrove Areas and enhance Mangrove cover by replantation in the open mud flats etc. Financial Assistance is given to coastal State Governments/Union Territories for implementation of Management Action Plan on Mangroves under the Scheme. One hundred percent assistance is given on grant basis to Coastal States / Union Territories for activities like Survey and Demarcation, Afforestation, Restoration, Alternative / Supplementary Livelihoods, Protection Measures and Education & Awareness.

On an average, an annual target comprises about 3,000 hectares on a country wide basis. The areas supported are among the thirty eight areas (Annexure-I) as already identified by MoEF for intensive conservation. During 2009-10, financial assistance to the tune of Rs. 6.25/- crores has been distributed among West Bengal, Orissa, Andhra Pradesh, Tamil Nadu, Kerala, Karnataka, Goa and Gujarat for Conservation & Management of

Table-3. Mangroves Sites in India

State/Union Territories	Mangrove Sites
West Bengal	1. Sunderbans
Orissa	2. Bhaitarkanika 3. Mahanadi 4. Subernarekha 5. Devi - Kadua 6. Dhamra 7. Mangrove Genetic Resources Centre (Kalibhanj-Dia) 8. Chilka
Andhra Pradesh	9. Coringa 10. East Godavari 11. Krishna
Tamil Nadu	12. Pichavaram 13. Muthupet 14. Ramnad 15. Pulicat 16. Kazhuvveli
Andaman & Nicobar	17. North Andamans 18. Nicobar
Kerala	19. Vembanad 20. Kannur (Northern Kerala)
Karnataka	21. Coondapur 22. Dakshin Kannada/Honnavar 23. Karwar 24. Manglore Forest Division
Goa	25. Goa
Maharashtra	26. Achra-Ratnagiri 27. Devgarh-Vijay Durg 28. Veldur 29. Kundalika-Revdanda 30. Mumbra-Diva 31. Vikroli 32. Shreevardhan 33. Vaitarna 34. Vasai-Manori 35. Malvan
Gujarat	36. Gulf of Kutchh 37. Gulf of Khambhat 38. Dumas-Ubhrat

Table-4. State-wise Mangrove cover in India

(Area in km<sup>2</sup>)

S. No.	State/UT	Assessment Year										
		1987	1989	1991	1993	1995	1997	1999	2001	2003	2005	2007
1	Andhra Pradesh	495	405	399	378	383	383	397	333	329	354	353
2	Goa	0	3	3	3	3	5	5	5	16	16	17
3	Gujarat	427	412	397	419	689	901	1031	911	916	991	1,046
4	Karnataka	0	0	0	0	2	3	3	2	3	3	3
5	Kerala	0	0	0	0	0	0	0	0	8	5	5
6	Maharashtra	140	114	113	155	155	124	108	118	158	186	186
7	Orissa	199	192	195	195	195	211	215	219	203	217	221
8	Tamil Nadu	23	47	47	21	21	21	21	23	35	36	39
9	West Bengal	2,076	2,109	2,119	2,119	2,119	2,123	2,125	2,081	2,120	2,136	2,152
10	A&N Islands	686	973	971	966	966	966	966	789	658	635	615
11	Daman & Diu	0	0	0	0	0	0	0	0	1	1	1
12	Puducherry	0	0	0	0	0	0	0	0	1	1	1
	<b>Total</b>	4,046	<b>4,255</b>	<b>4,244</b>	<b>4,256</b>	<b>4,533</b>	<b>4,737</b>	<b>4,871</b>	<b>4,482</b>	<b>4,448</b>	<b>4,581</b>	<b>4,639</b>

Mangroves in these coastal States. New areas are added to the existing list on the basis of recommendation by the National Committee on Mangroves & Coral Reefs. The National Committee has been duly reconstituted by the Ministry on 19.09.2007.

The project entitled "Mangroves for Future (MFF): a strategy for promoting investment in Coastal Ecosystem Conservation" is being coordinated by World Conservation Union (IUCN) covering, initially, six Tsunami affected countries (including India) in South & South East Asia & Western Indian Ocean. The project involves collaboration between multiple partners, including government agencies, NGOs, Research Institutes, UN agencies and other multilateral bodies. India has agreed to participate in the project. To oversee and guide the entire India country programme under IUCN-MFF (India) Programme as well as review, monitor and evaluate its implementation, a National

Coordination Body (NCB) has been constituted by the Ministry. At the regional level, there is Regional Steering Committee to oversee the entire MFF programme in the six participating countries. India hosted the Fourth Regional Steering Committee Meeting at Sunderbans from 19-22 Jan, 2009. India was able to showcase the beauty, grandeur and wealth of mangrove biodiversity of Sunderbans, which is the largest mangrove swamp in the world. Apart from arriving at a number of decisions, the meeting served as common platform for sharing of experiences with other participating countries and representatives from United Nations Development Programme (UNDP), Food and Agriculture Organization (FAO), and International Union for Conservation of Nature (IUCN) etc. Six small grant projects (less than US\$ 25,000/-) have been under implementation under the MFF initiative during the current financial year. Three more small

grant projects are being launched during the current financial year. The 4th meeting of the NCB was held on 19.11.2009. During the meeting, the NCB discussed the large grants from the first cycle which had received positive appraisals by the MFF Secretariat. Three projects from the first call (two from Government of Gujarat and one from Sugandhi Devadason Marine Research Institute) which



Fig-10. Mangroves – the natural coast guards

were appraised in the RSC 5 at Seychelles and duly revised by the proponents were re-endorsed by NCB for forwarding to MFF Secretariat. Of the eleven new large grant proposals received, four were recommended by NCB in its meeting on 19.11.2009 for obtainment of financial support under MFF initiative. India attended RSC 5 held in Seychelles during 6-10 July, 2009 in which project entitled “Alternative Livelihood options for vulnerable mangrove resource users in the Sundarban Tiger Reserve, West Bengal” by Director, Sunderban Biosphere Reserve, Government of West Bengal was approved at a total cost of US \$ 3,00,000/-.

### Coral Reefs

The four major coral reefs areas identified for intensive conservation & management are: i) Gulf of Mannar, ii) Gulf of Kachchh, iii) Lakshadweep and iv) Andaman and Nicobar Islands. The emphasis

is on preventive aspects through monitoring and surveillance as the restoration work is both costly and time consuming. The Ministry

### Coral Reef Sites in India

States/Union Territories	Coral Reef Sites
Gujarat	i) Gulf of Kutch
Tamil Nadu	ii) Gulf of Mannar
A&N Islands	ii) A&N Islands
Lakshadweep	iv) Lakshadweep

provides financial assistance to the State Forest Departments of all the four identified coral reefs areas in the country for activities like monitoring, surveillance, education & awareness. Besides, the Ministry also supports R&D activities with emphasis on targeted research on coral biodiversity, its management including various aspects of pollution in these areas.



Fig-11. Corals – need conservation

The Indian reef area is estimated to be 2,375 sq km. For encouraging targeted research on both hard and soft corals in the country, the Ministry has established a National Coral Reef Research Centre at Port Blair.

The International Coral Reef Initiative (ICRI){a partnership among governments, international organization, and non-governmental organizations throughout the world} held its general meeting from 12-15 January, 2010 at Monaco. India (Dr. B.P. Nilaratna, Joint Secretary, MOEF) attended the meeting, made a country presentation and submitted a country report.

#### Monitoring mechanism for the Scheme on Conservation & Management of Mangroves & Coral Reefs

Two tier system at National and State level are in operation for effective coordination to implement the Scheme on Mangroves & Coral Reefs:

#### National level

- National Committee on Mangroves & Coral Reefs monitors the implementation of the approved Management Action Plans of the Coastal States & UTs. The National Committee met on 29-30 September, 2009 at Andhra University, Visakhapatnam and reviewed the Management Action Plans of Gujarat, Tamil Nadu, West Bengal, Orissa, Karnataka & Goa. The National Committee also discussed i) the significant research findings from ongoing projects on mangroves & coral reefs; ii) supplementary livelihood supports to local people in the villages surrounding ecologically fragile mangrove & coral reef areas; iii) role of education awareness in promoting conservation & management of mangroves & coral reefs; and iv) enabling activities and training requirements of various States/UTs.
- to supplement base line information on priority areas of research, research projects are sanctioned to Universities and research institutes. A meeting of the Expert Group-B on 'Conservation & Sustainable Utilization of Natural Resources: Mangroves & Coral Reefs' was held on 1-2 September, 2009. The Group reviewed four ongoing projects under mangroves & coral reefs, appraised twelve new projects and selected referees for them. The Group also scrutinized thirty three projects where comments of referees were available. Of these, eight projects were recommended for financial support.

These are being processed during the current financial year

### State Level

- State level Steering Committee have been constituted under the Chairmanship of Chief secretaries/Additional Chief secretaries/ Principal Secretaries of Department concerned having members from subject matter departments/ academicians/ stakeholders/ representative from Central Government to discuss Management Action Plans and review conservation activities undertaken from time to.

## Biosphere Reserves

### Introduction and Objective

Biosphere Reserves are areas of terrestrial and coastal ecosystems which are internationally recognized within the framework of UNESCO's Man and Biosphere (MAB) programme. These Reserves are required to meet a minimal set of criteria and adhere to a minimal set of conditions before being admitted to the World Network of Biosphere Reserves designated by UNESCO. The world's major ecosystem types and landscapes are represented in this network, which is devoted to conserving biological diversity, promoting research and monitoring as well as seeking to provide models of sustainable development in the service of human

kind with special reference to the local communities which mostly consist of traditional societies.

These Reserves are rich in biological and cultural diversity and encompass unique features of exceptionally pristine nature. The goal is to facilitate conservation of representative landscapes and their immense biological diversity and cultural heritage, foster economic and human development which is culturally and ecologically sustainable and to provide support for research, monitoring, education and information exchange. The scheme is a pioneering effort at pursuing the increasingly difficult yet urgent task of conserving ecological diversity under mounting pressures. India has been divided into ten Bio-geographic Zones and these zones together consist of twenty five Bio-geographic provinces. The aim is to designate one representative site as Biosphere Reserve in each Bio-geographic province for long term conservation.



Fig-12. View of Nanda Devi Biosphere Reserve

### Activities undertaken

The programme was initiated in 1986 and till date, sixteen sites have been designated as Biosphere Reserve (BR) in different parts of the country. Apart from sixteen sites already designated, a number of potential sites have been identified. The Ministry provides financial assistance to the respective State/UT Governments for conservation and management of the designated Biosphere Reserves. The Indian National Man and Biosphere (MAB) Committee constituted by the MoEF is an apex body to oversee the programme, provide policy guidelines and review the programme.

Out of the sixteen Biosphere Reserves designated nationally, seven Biosphere Reserves namely Sunderbans (West Bengal), Gulf of Mannar (Tamil Nadu), Nilgiri (Tamil Nadu, Kerala and Karnataka), Nanda Devi, (Uttarakhand), Pachmarhi (Madhya Pradesh), Simlipal (Orissa) and Nokrek (Meghalaya) have been included in the World Network of Biosphere Reserves so far. The proposals in respect of Khangchandang (Sikkim), Manas (Assam) and Great Nicobar (Andaman & Nicobar Islands) are under active consideration of the UNESCO for inclusion in the world Network. Efforts are on for getting remaining Biosphere Reserves included in the World Network of Biosphere Reserves.

A State wise list of sixteen Biosphere Reserves designated so far along with their area and location is given in Table-5.

Research and development projects are also supported in these designated Reserves and potential sites. A number of Research projects have completed during the

year (Annexure-IV) which provided baseline data helpful in the scientific management of these Reserves.

### Progress/Achievements made during the year

- Management Action Plans (MAPs) submitted by the concerned states were scrutinized and sanctioned for implementation of approved items of activities. A Workshop was organized in Pachmarhi Biosphere Reserve (Madhya Pradesh) for Biosphere Reserve Managers and Directors of Lead Gardens. The Workshop provided great opportunity for the managers and representatives of Lead Research Institutions to exchange views and experiences and interact with experts in the field.

### Comparison of progress in comparison to previous year

- During the year, proposals for nomination of Achnakmar-Amarkantak (Madhya Pradesh and Chattisgarh) and Augsthyamalai (Tamil Nadu and Kerala) biosphere reserves were prepared and are likely to be forwarded to UNESCO after receiving endorsement of the concerned State Governments.

### Regulatory Acts /Rules governing the programme

The Core areas of the Biosphere Reserves continue to be protected under the Wild Life (Protection) Act, 1972 and the Indian Forest Act, 1927 and Forest Conservation Act, 1980. However, a separate regulation within the framework of existing Environment (Protection) Act, 1986 is being firmed up to regulate activities within buffer and transition Zones of the Biosphere Reserves.



Table-5. List of Biosphere Reserves

S. No.	Name of the BR & total geographical area in km <sup>2</sup> given in parenthesis	Date of Designation	Location (States)
1.	Nilgiri (5520)*	1.8.86	Part of Wynad, Nagarhole, Bandipur and Madumalai, Nilambur, Silent Valley and Siruvani hills (Tamil Nadu, Kerala and Karnataka)
2.	Nanda Devi * (6497.03)	18.1.88	Part of Chamoli, Pithoragarh & Almora Districts and Valley of Flowers (Uttarakhand)
3.	Nokrek (820) *	1.9.88	Part of Garo Hills (Meghalaya)
4.	Manas (2837)	14.3.89	Part of Kokrajhar, Bongaigaon, Barpeta, Nalbari, Kamrup and Darang Districts (Assam)
5.	Sunderbans * (9630)	29.3.89	Part of delta of Ganges & Brahmaputra river system (West Bengal)
6.	Gulf of Mannar * (10500)	18.2.89	Indian part of Gulf of Mannar between India and Sri Lanka (Tamil Nadu)
7.	Great Nicobar (885)	6.1.89	Southern most islands of Andaman and Nicobar (A&N Islands)
8.	Similipal (4374) *	21.6.94	Part of Mayurbhanj district (Orissa)
9.	Dibru-Saikhowa (765)	28.7.97	Part of Dibrugarh and Tinsukia districts (Assam)
10	Dehang Debang (5111.5)	02.09.98	Part of Siang and Debang valley (Arunachal Pradesh)
11	Kanchanjunga ( 2619.92 )	07.02.2000	Parts of North and West Sikkim (Sikkim)
12.	Pachmarhi (4926.28)*	03.03.99	Parts of Betul, Hoshangabad and Chhindwara, district (Madhya Pradesh)
13.	Agasthyamalai (3500.36)	12.11.2001	Parts of Thirunelveli and Kanya Kumari Districts in Tamil Nadu and Thiruvanthapuram, Kollam and Pathanamthitta in Kerala (TamilNadu & Kerala)
14.	Achanakmar-Amarkantak ( 3835.51)	30.3.2005	Parts of Anuppur and Dindori districts of Madhya Pradesh and Parts of Bilaspur district of Chattisgarh State (Madhya Pradesh & Chattisgarh)
15.	Kachchh (12,454)	29.01.2008	Parts of Kachchh, Rajkot, Surendranagar and Patan Civil Districts of Gujarat State
16.	Cold Desert (7770)	28.08.09	Pin Valley National Park and surroundings; Chandratol and Sarchu & Kibber Wildlife Sanctuary in Himachal Pradesh.

\* BRs have been included in the World Network of UNESCO.

### Budget Allocation for the Scheme

An amount of Rs. 11 crore was allocated during the year and entire money is likely to be spent till 31st March, 2010.

Implementing organizations in most of the States are Forest Departments and other line Departments of the concerned State Governments.

### Biodiversity Conservation

#### Introduction and Objectives

Biodiversity is the variability among living organisms and ecological complexes of which they are part, including diversity within and between species and ecosystems. Biodiversity has direct consumptive value in food, agriculture, medicine and in industry.

A scheme on biodiversity conservation was initiated earlier to ensure coordination among various agencies dealing with the issues related to conservation of biodiversity and to review, monitor and evolve adequate policy instruments for the same

#### Convention on Biological Diversity

– The Convention on Biological Diversity (CBD), one of the key agreements adopted during the Earth Summit held in Rio de Janeiro in 1992, is the first comprehensive global agreement which addresses all aspects relating to biodiversity. The CBD, which has near universal membership with one hundred ninety two countries as its Parties, sets out commitments for maintaining the world's ecological underpinnings, while pursuing economic development. The Convention, while reaffirming sovereign rights of nations over their biological resources, establishes three

main goals: the conservation of biological diversity, the sustainable use of its components, and the fair and equitable sharing of the benefits arising out of the use of genetic resources. India is a Party to the CBD.

- In pursuance of various decisions of COP-9 to the CBD held in May 2008, India has been responding to various notifications being received from the CBD Secretariat, inter alia by making submissions, and nominating experts for various expert group meetings.
- India has prepared its Fourth National Report through a consultative process and submitted it to the CBD Secretariat.
- India hosted two meetings for the CBD this year: an Expert Meeting on Traditional Knowledge in Hyderabad from 16-19 June 2009, and an Asia Pacific Regional Workshop on Protected Areas in Dehradun on 12-15 October, 2009.
- Indian delegations participated actively in various meetings held under the aegis of CBD, including in two important negotiation meetings for development of an international regime on access and benefit sharing, in Paris in April 2009 and in Montreal in November 2009. The last negotiation meeting is scheduled to be held in Cartagena in March 2010.

#### National Biodiversity Action Plan

- The National Biodiversity Action Plan (NBAP) prepared by the Ministry of Environment and Forests and released formally in February 2009, has been sent to all concerned Ministries/Depts specialized agencies, and to all units within

the Ministry, with a request to initiate follow-up action on the action points listed in the NBAP, keeping in view the matrix of implementation in chapter-6 of this document to facilitate regular monitoring of implementation of NBAP.

### Biological Diversity Act

- In pursuance to the CBD, India had enacted the Biological Diversity Act in 2002 following a widespread consultative process over a period of eight years. The Biological Rules were notified thereafter in 2004. The Act gives effect to the provisions of the CBD. It also addresses access to biological resources and associated traditional knowledge to ensure equitable sharing of benefits arising out of their use to the country and its people, thereby contributing to achieving the third objective of the CBD. India is one of the first few countries to have enacted such a legislation. The Act is to be implemented through a three-tiered institutional structure: National Biodiversity Authority (NBA), State Biodiversity Boards (SBBs) and Biodiversity Management Committees (BMCs).
- The National Biodiversity Authority (NBA) is a body corporate established in accordance with the provisions of Section 8 of the Biological Diversity Act, 2002, at Chennai w.e.f. 1st October, 2003
- Twenty two States have so far set up the State Biodiversity Boards. These are : Andhra Pradesh, Arunachal Pradesh, Chhattisgarh, Goa, Gujarat, Haryana, Himachal Pradesh, Jharkhand, Karnataka,



Fig-13. Green lichens – bio indicators of environmental changes

Kerala, Madhya Pradesh, Manipur, Mizoram, Nagaland, Orissa, Punjab, Sikkim, Tamil Nadu, Tripura, Uttarakhand, Uttar Pradesh and West Bengal.

- BMCs have been set up so far in six States. Other states have been requested to expedite setting up of SBBs, where not set up, and strengthen implementation of the Act.
- Two Authority meetings (14 and 15) were held on 21 July 2009 and 29 October 2009 and important decisions were taken on different matters during the year.
- One hundred forty one applications for access to bioresources were received and are at various stages of processing during the period.
- Some of the important actions taken up to implement various provisions of the Act include the following
  - A principal notification authorizing officers for filing complaints for

cognizance of offences under Section 61 of the Act was issued on 17.11.08. An amendment to this Notification authorising forest officers for this purpose was issued on 1.8.09.

- In pursuance of Section 38 of the Act relating to notification of threatened species, the Ministry has got prepared a State-wise list of threatened plants and animals, alongwith guidelines for their rehabilitation in consultation with the Botanical Survey of India and Zoological Survey of India, and send the same to State Governments for their comments. On receipt of comments from the states, notifications were issued for Himachal Pradesh on 19.3.2009, Uttarakhand, Uttar Pradesh and Kerala on 23.4.2009, and Orissa, Mizoram and Meghalaya on 5th October 2009.
- State Governments have been requested to send their views on the areas of biodiversity importance, which could be notified as Biodiversity Heritage Sites under Section 37. The NBA is in the process of developing draft Rules for management of these sites.
- State Governments have been requested to identify any biodiversity rich areas threatened by overuse or neglect as per Section 36 (2), and NBA has been requested to prepare guidelines for management of these areas.
- The process for finalizing the list of normally traded commodities was finalized and the notification issued on 30.10.2009 under section 40.
- The format for Peoples Biodiversity Registers and guidelines for benefit

sharing have been finalized in the NBA

- In order to strengthen implementation of the Act and to build capacity of the institutional structures involved in its implementation, a project identification form (PIF) and project preparation grant were prepared for accessing funds from Global Environment Facility (GEF) for a Full Scale Project through United Nations Environment Programme (UNEP). The proposal has been approved by GEF in May 2009 with GEF contribution of USD four million. This is the first national project to have been approved by GEF on access and benefit sharing. The NBA is now in the process of developing the full project.
- The Ministry has also developed a project with United Nations Development Programme (UNDP) for USD one million for strengthening the implementation of the Act. This project will be implemented in two States, Jharkhand and Madhya Pradesh. This project was formally launched for Jharkhand in Ranchi on 15 September, 2009, and for Madhya Pradesh in Bhopal on 15th October, 2009.
- New premises of National Biodiversity Authority at 5th Floor, TICEL Biopark, Taramani, Chennai was inaugurated by the Minister for Environment and Forests, Shri Jairam Ramesh, on 19 August 2009. For effective liaison with different/ministries/ organizations etc. located in Delhi, the NBA has opened its liaison office in the Campus of National Seed Corporation Bhawan, Pusa campus, New Delhi.
- A task force on Biodiversity Management Committees has been constituted for

preparation of guidelines on creating structure, running administration and maintaining of accounts and other related matters.

- Fourth meeting of State Biodiversity Boards was held on 10-11 September, 2009 at Kolkata to review the progress and discuss the issues in respect of functioning of SBB, establishment of BMCs, biodiversity fund, SBB rules, People's Biodiversity Register, selection of Biodiversity Heritage sites etc

#### Progress / Achievements made during the year

In pursuance of various decisions of COP-9 to the CBD held in May 2008, India has been responding to various notifications being received from the CBD Secretariat, inter alia by making submissions, and nominating experts for various expert group meetings.

India has prepared its Fourth National Report through a consultative process and submitted it to the CBD Secretariat.

India hosted two meetings for the CBD this year: an Expert Meeting on Traditional Knowledge in Hyderabad from 16-19 June 2009, and an Asia Pacific Regional Workshop on Protected Areas in Dehradun on 12-15 October, 2009.

The National Biodiversity Action Plan (NBAP) prepared by

the Ministry of Environment and Forests and released formally in Feb 2009, has been sent to all concerned Ministries/Depts specialized agencies, and to all units within the Ministry, with a request to initiate follow-up action on the action points listed in the NBAP, keeping in view the matrix of implementation in chapter-6 of this document to facilitate regular monitoring of implementation of NBAP

Several steps have been taken to strengthen the implementation of the Biological Diversity Act

#### Budget Allocation of the Scheme

An allocation of Rs.2.62 crore was made for the year 2009-10 against which has been utilized fully.

#### Biodiversity Scheme / Genetic Engineering Approval Committee (GEAC)

The Ministry of Environment and



Fig-14. The blue pansy butterfly (*Junonia orithyia*)

Forests (MoEF), under the Environment (Protection) Act 1986, has notified the "Rules for the Manufacture, Use, Import, Export and Storage of Hazardous Microorganisms/Genetically Engineered Organisms or Cells 1989" (known as Rules, 1989) to ensure that research and development and testing of LMOs prior to environmental release are conducted in a safe and scientific manner.

The Genetic Engineering Approval Committee (GAC), the apex body under Rules 1989 has the mandate to accord approval of activities involving (i) large scale use of GMOS in research and (ii) environmental release of GMOs,

The rules also cover the application of hazardous microorganisms which may not be genetically modified. Hazardous microorganisms include those which are pathogenic to animals as well as plants. Six meetings of the GEAC have been held from April, 2009 till date.

### Progress/Achievements made during the year Commercial Release of Transgenic Crops

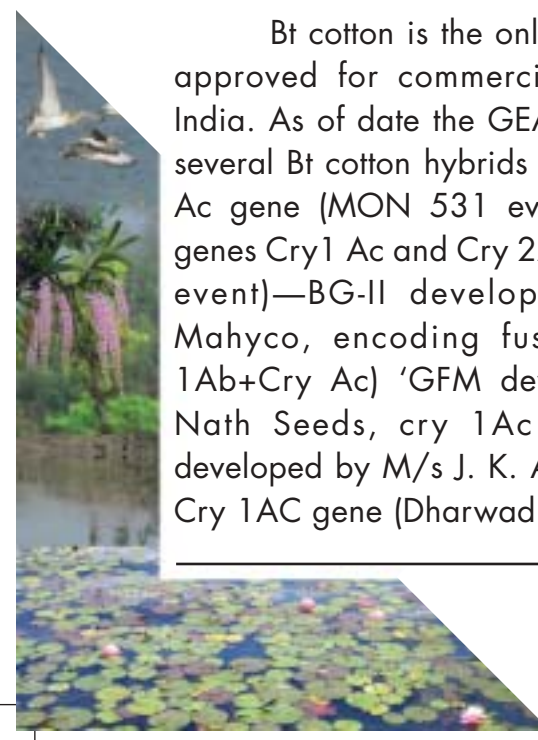

Bt cotton is the only transgenic crop approved for commercial cultivation in India. As of date the GEAC has approved several Bt cotton hybrids expressing Cry 1 Ac gene (MON 531 event) and stacked genes Cry1 Ac and Cry 2Ab (MON 15985 event)—BG-II developed by M/s Mahyco, encoding fusion genes (cry 1Ab+Cry Ac) 'GFM developed by M/s Nath Seeds, cry 1Ac gene (Event-1) developed by M/s J. K. Agri Genetics Ltd, Cry 1AC gene (Dharwad event) developed

by CICR and Cry 1C (event 9124) developed by M/s Metahelix Life Sciences.

During Kharif 2009, the Standing Committee constituted by the GEAC under the new 'Event Based approval Mechanism' has recommended 610 Bt cotton hybrids for commercial cultivation.

### Status of approval of GM Food crops in India

Transgenic brinjal, rice, okra, cauliflower, cabbage, castor, groundnut, tomato, sorghum, potato, maize developed by both private and public sector institutions are under various stages of research and development/biosafety testing with the approval of the GEAC for generation of biosafety data.

Bt Brinjal event EE-1 has been developed on a Public Private Partnership mode under the aegis of Agriculture Biotechnology Support Project from Cornell University wherein the Bt technology available with M/s Mahyco has been transferred to Tamil Nadu Agriculture University, Coimbatore, University of Agricultural Sciences, Dharwad and Indian Institute of Vegetable Research, Varanasi free of cost. As part of this collaboration, the technology has also been transferred to University of Agriculture in Philippines and Bangladesh.

The Bt brinjal event EE-1 contains cry 1Ac gene from *Bacillus thuringiensis* tolerant to the fruit and shoot borer is the first GM food crop under advanced stages of field testing. Bt brinjal has been developed in compliance with the regulatory procedures and biosafety guidelines.

The GEAC in the meeting held on 14.10.2009 wherein the GEAC concluded that Bt brinjal is safe for environmental release taking into consideration the findings of the review by three high level technical Committees namely; the RCGM and two Expert Committees constituted by the GEAC in 2006 and 2009. The GEAC decided to forward the recommendations and report of the Expert Committee (EC-II) on the safety and efficacy of Bt brinjal event EE-1 to the Government for taking a final view.

Subsequently the Ministry decided to organize public consultations at seven locations (mainly brinjal growing areas) before a final view on the matter is taken. Public consultations at Kolkata, Bhubaneswar, Ahmedabad, Nagpur, Chandigarh, Hyderabad and Bangalore have been completed during January-February 2010. The Ministry for Environment and Forests has decided to impose a moratorium on Bt brinjal until all concerns expressed by the public, NGOs, scientists and the State Governments are addressed adequately.

### Streamlining of the Biosafety Regulatory Procedure under Rules, 1989

- The Gazette Notification exempting GM processed food and products thereof from the purview of Rules, 1989 issued on 15.10.2007 has been kept in abeyance till March 2010 until the Food Safety and Standards Authority set up under the aegis of the Ministry of Health and Family welfare is made operational.
- The new event based approval mechanism has been made operational during Kharif 2009. A new procedure

for commercial release of Bt cotton hybrids expressing approved events has been put in place.

- Review of the existing national regulatory biosafety framework with a view to harmonize the obligations under Cartagena Protocol on Biosafety (CPB) is in progress.
- Draft guidance document for information/data generation and documentation for safety assessment of GE Plants during biosafety research level trials -I (BRL-I) and biosafety research level trials -II (BRL-II) has been prepared and is awaiting GEAC approval.
- Ex *ante* assessment of socio-economic benefits of Bt brinjal has been initiated by NCAP with the financial support of MoEF. Final report is awaited.
- Biological documents for Cotton, Brinjal, Okra, Maize and Rice have been developed.

### Capacity Building to facilitate compliance of Biosafety regulation

As part of the USDA Capacity Building project on biosafety, the second short term course on 'Risk Assessment of GM crops' at Michigan State University' held in October, 2009 was attended by eight agriculture Scientists.

### Biodiversity Scheme/ Cartagena Biosafety Protocol

#### Objective

The Cartagena Protocol on Biosafety, the first international regulatory framework for safe transfer, handling and use of living Modified Organisms (LMOs) was negotiated under the aegis of the Convention on

Biological Diversity (CBD). The Protocol was adopted on 29<sup>th</sup> January 2000. India has acceded to the Biosafety Protocol on 17<sup>th</sup> January 2003. The Protocol has come into force on 11<sup>th</sup> September 2003. As of date 157 countries are Parties to the Protocol to the Cartagena Protocol (COP-MOP) on Biosafety have been held so far.

The main objective of the Protocol is to contribute to ensuring an adequate level of protection in the field of the safe transfer, handling of LMOs resulting from modern biotechnology that may have adverse effect on the conservation and sustainable use biological diversity, taking into account risk to human health.

### Progress/achievements made during the year

#### Fifth Meeting of the Conference of Parties serving as Members of Parties (COP-MOP-5)

The fifth meeting of the Conference of Parties serving as Members of the Parties to the Cartagena Protocol (COP-MOP) on Biosafety will be held at Nagoya, Japan from 11-15, October, 2010. Preparatory work for finalizing the negotiating document has been initiated.

The meeting will consider one of the most contentious issues pertaining to rules and procedure for a liability and redress regime under Article 27 of the CPB. To continue negotiation on the liability redress regime during the inter-sessional period COP-MOP-4 decided to set up a 'Group of the Friends of the Co-Chairs' comprising of six representatives from Asia Pacific Group, Africa Group, Latin American countries, EU, Norway, Japan and New Zealand, Asia

Pacific is represented by India, Philippines and Palau.

Pursuant to the above decision, the first meeting of the 'Friends of the Co-Chairs' was held in February 2008 in Mexico. The second meeting of the 'Group of the Friends of the Co-Chairs' was held in February 2010 at Kula Lumpur.

The meeting was successful in streamlining the operational texts pertaining to the section on legally binding Supplementary Protocol on Liability and Redress in the context of Cartagena Protocol on Biosafety on an administrative approach. The section on legally binding civil liability clause and the non-legally binding guidelines for civil liability regime is yet to be finalized.

#### Capacity Building

The Ministry has taken a lead in the preparation of the first 'Full Scale Project' (FSP) document for capacity building on biosafety under the GEF program. FSP document has been submitted for GEF approval in September 2009. The project is expected to commence by May 2010.

The India delegation participated in the 'Regional Biosafety Workshop' at Bangkok organized by FAO from 30 November-4 December 2009.

The India delegation participated in the Sixth Coordination Meeting for Government and Organizations Implementing or funding Biosafety Capacity Building Activities and Seventh Meeting of the Liaison Group on Capacity Building for Biosafety was held from 1-5 Feb, 2010 in Siem Reap, Cambodia.



## GOI-UNDP CCF-II project "Biodiversity Conservation through Community based Natural Resource Management"

The rural populations are primary stakeholders in biodiversity conservation and sustainable use. This approach attempts to address the problems of poverty and natural resources degradation. Therefore, integration of conservation and developmental activities addressing livelihood security of the communities assumes importance. Revitalization of traditional institutions of decentralized decision-making is necessary to ensure sustainability in conservation and livelihood approaches.

The project aims to focus on component like conservation of species and habitats through responsible community-based management; Ecological restoration including species recovery programmes; gender, equity, tenure and resource rights over common pool resources; Revitalization of indigenous knowledge, equitable customary laws and practices and ethical values recognizing socio-economic and gender differences; Nurturing existing as well as new self-governing community institutions following principles of participatory decision-making, gender and social equity.

The project is being implemented in four states namely, Arunachal Pradesh, Chattisgarh, Jharkhand and Orissa.

These four states are primarily tribal dominated and therefore forest dependent livelihoods will be largely benefited from interventions that are proposed under the project. Arunachal Pradesh has over eighty percent of the land area under forests, while

Jharkhand, Chhattisgarh and Orissa have large stretches of forest that are controlled and managed by the communities. In these states, development of alternative sources of income assumes importance as the communities depends mainly on the natural resources for their livelihoods.

The MoEF is the implementing agency of the project. At National level, a National Steering Committee (NSC) and an Empowered Project Steering Committee (EPSC) have been constituted for overall coordination and implementation of the project. A National Project Director (NPD), has been designated and a Project Management Unit (PMU), has been established at MOEF for administrative support to the Project. The NSC lay down the guidelines for the project implementation and also reviews the progress periodically. The EPSC approves the Annual work plan and expenditure as per approved budget and also provides the feedback for review the progress by NSC.

### Progress during the year

The details of state-wise physical progress made during the period are as follows:

#### Arunachal Pradesh

- Twenty two Village Biodiversity Conservation Councils (VBCCs) formed and orientation meeting were organized in both project sites i.e. Tawang-west kameng and Apatani Plateau.
- One hundred beneficiaries identified for LPG set distribution in consultation with VBCC, Deputy Commissioner and other state govt. officials.

- Forty farmers of Apatani plateau were given demonstration and hands on training on seventeen low-cost rural technologies.
- Sixty piglets were distributed to villagers in Apatani site.
- Three High Altitude Nursery developed for Medicinal & horticulture Plants and saplings of *Taxus wallichiana* distributed to VBCC members at Apatani site.

### Orissa

- Construction of Community hall and balwadi centre, one hundred thirty toilets completed in Berhampur site.
- Human Health camps and Poultry Vaccination camps organized in all project sites.
- Plantation of 36,000 saplings in Berhampur and 50,000 saplings in Sambhalpur sites completed .
- Renovation of four No of ponds completed and fingerlings of three local varieties of fish introduced. In addition to above, pisciculture has also started in four other existing ponds in Khurda site.
- One Pump set (five HP) provided to farmers for lift irrigation and Tailoring enterprise established at Khurda site.
- 1.2 lakhs of fingerlings of two local varieties of fish introduced; four country boats and five small boats and two thrashed sheds constructed at Berhampur site.
- Agriculture implements, HYV seeds, fertilizer insecticide and pump set provided to farmers at Sambhalpur site.
- Rice-puff machine installed in Berhampur and construction of storage

godown and drying yard completed at Sambhalpur.

- Vocational training on poultry management, incense stick making, tailoring imparted to local communities in all three sites and exposure visits conducted for members of village conservation committees.

### Chattisgarh

- *In-situ* conservation of Biodiversity completed in 3000 hectare area in all three sites.
- Resource survey, ethno-botanical survey and documentation of flora of herbal health value and ITK completed in all three sites.
- Three workshops on Sustainable use of Natural Resource organized and sixteen water holes for wildlife constructed.
- Herbal health care centre established at Jagdalpur site.
- Lac based micro-enterprises established in all three sites.
- Mahul leaf molding unit; Imli, Giloy, Stawar and other NTFPs processing units established.

### Jharkhand

- Four ha of sacred grove developed, Added Natural Regeneration (ANR) completed in seventeen hectare community forest, ten hectare of village forest at Khunti site.
- Cultivation of Medicinal Plants completed in five Acre at Palamau & 4.5 acre at Deodhar site.
- Plantation of Fuel-wood & Fodder spp completed in about fifty hectare in Deodhar,

- 15 acre in Palamau, twenty acre in Bokaro site.
- Two Water percolation tank, six rock-filled dam and three farm pond each constructed in Palamau site.
- Construction of Chuan (three No) completed at Khunti site; construction of twenty No. of small water conservation structures, three lift irrigation system and 2500 ft long trench completed at Palajore site.
- Two vermi-compost unit at Deodhar site and nineteen stall feeding-cum common sheds for goatry constructed at Palajore site.
- Seed money distributed to twenty SHGs at Palamau site, thirty seven families at Khunti site for NTFP purchase, rope making , goatry, poultry, piggery and vegetable cultivation.
- One hundred farmers were trained on SRI technique of paddy & applied in seventy acre at Deodhar site.
- People Biodiversity Register (PBR) preparation work is under process at all sites in Jharkhand.

**Budget Allocation**

A total sum of approx Rs. 13.50 crores (US\$ 3 Million) is available under the project. A grant of Rs.611 lakhs have been released till 31<sup>st</sup> December, 2009 to four identified implementing agencies as given in Table-6.

**All India Coordinated Project on Capacity Building in Taxonomy (AICOPTAX)**

Taxonomy is the science which helps in exploration, identification and description

Table-6. Budget allocation under the project

State	Coordinating Agency	Amount sanctioned for three years duration of the project	Amount released till 31 <sup>st</sup> Dec, 2009
Arunachal Pradesh	G.B. Pant Institute of Himalayan Environment & Development, N-E Unit, Itanagar	252.89	133.85
Jharkhand	Institute of Forest Productivity, Ranchi	250.00	157.67
Orissa	Regional Plant Resource Centre, Bhubaneshwar	250.00	142.10
Chattisgarh	State Minor Forest Produce (T & D) Coop. Federation, Raipur	250.00	171.38

of living organisms. However, the scope of taxonomy does not end with this. A sound taxonomic base is a pre-requisite for environmental assessment, ecological research, effective conservation, management and sustainable use of biological resources.

So far around 90,000 species of animals and 47,000 species of plants have been identified and described but a large number of animals and plants are yet to be explored, identified and described.

As a signatory to the Convention on Biological Diversity (CBD) held in Rio de Janeiro in 1992, India has committed itself to capacity building in taxonomy and taken up exploration and preparation of an inventory of living organisms. The Ministry of Environment and Forests (MoEF) has set up an All India Coordinated Project on Taxonomy. The Project has organized specialist groups drawn from Universities, Botanical and Zoological Surveys of India to take up taxonomic work on animal viruses, bacteria and archaea, algae, fungi, lichens, bryophytes, pteridophytes, gymnosperms, palms, grasses, bamboos, orchids, helminthes and nematodes, Microlepidoptera and Mollusca. Training in plant and animal biosystematics has also been recognized as an important component. The Scheme has been continued during 2009-10 and financial assistance has been provided to thirteen thematic areas for undertaking taxonomic research work.

Several new records of wild flora and fauna have been made. Several new species have also been discovered. These are being documented and verified with voucher specimens for authenticity before publication

during the XI Plan Period. Discovery of species new to science will be the major impact of the AICOPTAX Scheme. The significant achievements of the entire AICOPTAX Scheme since its inception till 2007 are being brought out in a book form with the help of BSI & ZSI.

Taxonomy is a dying science. The expertise available in the country is either aging or retiring. Efforts are being made to ensure that Taxonomy is revived and resurrected during the XI Plan. The Steering Committee for the AICOPTAX Scheme has been reconstituted on 3.7.2008 along with the formation of a Project Monitoring Unit (PMU). A meeting of the Steering Committee was held on 13<sup>th</sup> February, 2009 during which the entire scheme was reviewed and following five new thematic areas have been proposed:

- Crustacea
- Coleoptera
- Hymenoptera
- Arachnidae
- Floristic and Faunistic Surveys of North Eastern Region of the Country

Three projects have been conceived under the thematic area Crustacea; six projects under Coleoptera; six projects under Hymenoptera; four projects under Arachnidae; fourteen projects under Floristic Surveys of North Eastern Region and one project under Faunistic Survey in the North East Region of the country. These are being processed in consultation with Integrated Finance Division of the Ministry for sanction & release of funds during the current financial year.

During the meeting on 13.02.2009, the Steering Committee also emphasized the following:

- The Steering Committee recalled that the coordination unit on Microlepidoptera at Punjabi University, Patiala has been discontinued. Accordingly, it recommended that the thematic area on Microlepidoptera should be strengthened urgently by giving a project to ZSI, Solan. The decision of the Steering Committee is being processed during the current financial year.
- The Steering Committee deliberated on need for establishment at least one repository each of algal and fungal collections in the country. At present, there are no designated centres for these groups. The Committee strongly recommended that the macro algal and fungal collections have to be in the form of herbarium or liquid collections, while micro algal and fungal collections as culture collections and in the form of slides (stained) and photographed. An elaborate infrastructural facility with required manpower is essential for running the national culture collections. It was recommended that an Algal Cultural Collection Centre be established at CAS in Botany, University of Madras, Chennai while fungal collection centre be established at the Agharkar Research Institute, Pune. These centres need to be designated as National Centres by National Biodiversity Authority (NBA). The Committee also recommended that both the National Centres be implemented from 2009-10 and supported for at least a period of five years. Accordingly, the Centres are being operationalized during the current financial year.

## Assistance to Botanic Gardens

The scheme on Assistance to Botanic Gardens, Botanic sections in popular gardens and Centers of Ex-Situ Conservation was initiated in 1992 to augment facilities for ex-situ conservation of rare, endangered, threatened and endemic plants. One time financial assistance is provided to identified Botanic Gardens and Centres of Ex-situ Conservation for improvement of their infrastructural facilities to facilitate ex-situ conservation of rare endangered, threatened endemic plants.

Under the scheme, two hundred sixty eight projects have been supported so far to various organization maintaining botanic gardens and Centres of ex-situ conservation. This is gradually helping in facilitating ex-situ conservation of rare endemic plants. A detailed guideline has been issued for guidance of proponents.

The Expert Group constituted by Ministry identifies and recommend proposals received for financial assistance under the scheme and also monitors and reviews progress of the sanctioned projects. During the year, ten projects have been sanctioned which includes three Lead gardens. A list of organizations which have been sanctioned grant is given in Annexure. Based on the criteria prescribed in the guidelines, 'Lead Gardens' are being developed in different phyto-geographic zones of the country to provide necessary expertise for smaller gardens. These gardens shall be equipped with modern facilities to enable them to perform their responsibilities.

## Botanic Garden of India Republic (BGIR), NOIDA

### Introduction

The Botanic Garden of India Republic (BGIR) was set up in April 2002 as part of the Botanical Survey of India after the Expenditure Finance Committee, MoEF, approval in the same year. The scheme was identified as a "Green Channel" project under the National Jai Vigyan Science & Technology Mission of the Ministry of Science & Technology and approved by the Planning Commission. The botanic garden was *inter-alia* established with the following goals: *ex situ* conservation and propagation of rare and indigenous plants, to serve as a 'centre of excellence' for research and training, and to build public awareness through environmental education. The project outlay was for Rs.3775.85 lakhs.

### BGIR Programme Activities

The BGIR is presently carrying out the basic scientific/technical work to facilitate project execution in context of research/field operations. The following work has been done during the year.

#### – Woodland/Arboretum Development Programme

The programme continued with about one thousand forty saplings belonging to seventy nine species being introduced in the various sections of the garden. Saplings of about forty four indigenous plant species, including *Acrocarpus fraxinifolius*, *adenanthera pavoniana*, *Pterocarpus marsupium*, *Madhuca longifolia*, etc., were introduced in the woodlands section. Similarly, about twenty six species were

introduced into the Economic Plants Arboretum. These include some important tree species such as *Pterocarpus santalinus*, *Sapindus mukorossi*, *Diploknema butyracea*, *Commiphora caudate*, etc. In the Arboretum of fruit yielding trees about fifteen species were introduced this year.

#### – Conservation programme

Conservation studies including multiplication of some of the endangered species such as *Cycas beddomei*, *Frerea indica*, *Hildgardia populnifolia*, etc. continued.

- A small Ginger Garden was developed this year. The gingers species have potential economic and medicinal value. As part of the *ex situ* conservation programme BGIR now has seventy nine holdings of ginger germplasm material meant for introduction in this garden. These include some rare ones such as *Amomum cannicarpum*, *A. ghaticum*, *A. muricatum*, *Curcuma haritha*, *C. mutabilis*, *C. vamana*, etc.
- Specialist collections of bamboos and carallumas have also been initiated this year.
- Avenue plantation along some portions of the newly constructed circular WBM road was done. The avenue trees include *Samanea saman*, *Pterospermum xylocarpum*, *Terminalia arjuna*, *T. cattapa*, *Parkia biglandulosa*, etc.

#### – Conservation Research/Training Programmes

Laboratory studies including germination trials for some selected plant species were carried out as part of routine experimentation. Germination trials

showing fifty percent success rare yielded one thousand three hundred eighty eight seedlings to 16 species. The seedlings raised are hardened/stocked in the nethouses and later introduced into the various sections of the garden.

- The herbarium development work continued with maintenance of the herbarium specimens collected as part of the Digital Flora of NCT Project.
  - The Database Development Programme activity has resulted in the electronic version of the Flora of India volumes published by the Botanical Survey of India. Plans are afoot to make the CDs available for wider dissemination of scientific output of BSI. The Introduced Plants Database, Threatened Plants Database, etc. are under development. These databases are expected to supplement the in-house conservation research as well as education and extension programmes of BGIR.
  - BGIR has also initiated an extension training programme for undergraduate/ B.Tech. students, working on voluntary basis on the Seed Bank Laboratory for their dissertation. Visitors from nearby universities and research institutes are also exposed to the various garden sections through guided trips. Some public/advisory services were also rendered for colleges/institutions in Delhi.
- **Medicinal Plants Conservation Programme**
- Development of the Medicinal Plants Section, Ayur Vatica, continued with augmentation of more than one hundred fifty seedlings belonging to eleven medicinal

plants, including *Eleutherine palmifolia*, *Curculigo orchioides*, *Abroma augusta*, etc. The Medicinal Plants Section at BGIR is planned as repository of medicinal plants of the Indo-gangetic region. The formal section is divided into eight sectors each containing twelve species laid out thematically according to their therapeutic use in treatment of various ailments generally in the Ayurvedic system of medicine. The section has become the main attraction of visitors of the garden.

#### Infrastructure development

Some enabling activities such as development of a circular access road and irrigation pipeline were taken up; these facilities are expected to become fully operational soon. Other civil work items such as entrance gate with security hut and nature shop are in the pipeline. It may be mentioned that BGIR now has a Metro connectivity which makes BGIR the only known botanic garden with a Metro station within the garden campus. This is expected to substantially increase the number of visitors to the garden.

#### UNDP-GOI-GEF-II-Programme on Promoting Conservation of Medicinal Plants and Traditional Knowledge for Enhancing Health and Livelihood Security and Mainstreaming, Conservation and Sustainable use of Medicinal Plant Biodiversity

The ever increasing demand of Medicinal & Aromatic Plants (MAPs) as healers and health rejuvenators for the traditional or the so called alternative medicinal practices such as Ayurveda, Siddha, Unani, traditional Chinese and Tibetan medicines has led to an indiscriminate

extraction and unregulated trade of these from its natural habitat i.e. the Forests. This has resulted into a degradation of this resource affecting the major livelihood of a majority of the village population, thereby having a significant impact on the socio-economic as well as the environmental well-being of the country.

Realising the threat to the Medicinal Plant Bio-diversity, a need was felt to conserve, protect, cultivate, propagate, improve harvesting and collection practices of medicinal plants of the country. Besides this, a long-term strategy at the global, national and local levels for conservation of medicinal plant resources and using their rich associated traditional knowledge, for social, cultural and

economic benefits was also felt necessary. With this objective, the Ministry of Environment and Forests and UNDP have taken up two projects namely GOI-UNDP-CCF-II Promoting Conservation of Medicinal Plant and Traditional Knowledge for Enhancing Health and Livelihood Security and GOI-GEF-UNDP Project on Mainstreaming Conservation and Sustainable Use of Medicinal Plant Biodiversity in three Indian States.

#### UNDP-GOI-CCF-II Programme on Promoting Conservation of Medicinal Plant and Traditional Knowledge for Enhancing Health and Livelihood Security Project

UNDP-GOI-CCF-II Programme on Promoting Conservation of Medicinal Plant and Traditional Knowledge for Enhancing Health and Livelihood Security Project has an outlay of US\$30,00,000 (Three Million US\$) (Rs 12.90 Crores) and was initiated in May 2006. The project is being undertaken in nine States viz. Andhra Pradesh, Karnataka, Kerala, Madhya Pradesh, Maharashtra, Orissa, Rajasthan, Tamil Nadu and West Bengal US\$2.97 Million has been released so far.

The main objective of the project is supporting conservation of medicinal plants and traditional knowledge for enhancing health and livelihood security. The key thrust of the project is to promote conservation of medicinal plants and related traditional knowledge with local people and mainstreaming these into the existing policies and programmes of the forestry and health sector.

The Foundation for Revitalization of Local Health Tradition (FRLHT), Bengaluru is the designated National Focal Point for the



Fig-15. *Phlomis bracteosa*, leaves and flowers are used as medicines



programme. The program is being implemented through State Forest Departments and the Conservator of the Forest is the State Focal Point. The project is overseen by a Project Monitoring Board (PMB) and is implemented by an Empowered Project Standing Committee (EPSC). During the year two meetings of EPSC were held. The project is now about to be completed by 31<sup>st</sup> March 2010. Some of the activities carried out under the project are as follows-

- Conservation, Assessment, Management Prioritization (CAMP) workshops have been organized in Orissa, Rajasthan, West Bengal, Kerala and Tamil Nadu and CAMP Reports have been published for Orissa and West Bengal.
- A list of three hundred sixteen plants has been prepared for Assessment and out of which one hundred twenty six have been identified as heavily traded on endemic or phylogenetically distinct. Degrees of threat has been assigned to these species as per the IUCN criteria and categories through Conservation Assessment and Management Prioritization Workshops (CAMP) organized in various states. Accordingly fourteen species are assigned as critically endangered forty three species as endangered and fifty nine species as vulnerable.
- Thirty five Medicinal Plants Conservation Areas (MPCAs) were identified in four states to conserve the endangered medicinal plants. Out of these, thirty two MPCAs have established however twenty are supported under the Project and the remaining are the offshoot of the study to be undertaken

by the States. Sites have been prepared for Madhya Pradesh, Orissa and Rajasthan. Management plans have been prepared for all the thirty two MPCAs.

- Prepared trade regulation report for prioritized species of Tamil Nadu.
- Infrastructure for five State Level Medicinal Plant Seed Centres have been developed and Nurseries to raised 67 prioritized species have been establishment in Karnataka, Kerala, Tamil Nadu, Andhra Pradesh.
- One lakh seedlings of *Decalepis hamiltonii* – a critically endangered and highly traded medicinal plant from Karnataka have been distributed for propagation.
- Farmers meeting cum workshop was organized at Dharwad, Karnataka to discuss on planting material, propagation techniques and planting of medicinal plants.
- Twenty three species were identified for sustainable harvest out of which seventeen species (6 in Karnataka, six in Madhya Pradesh and five in Tamil Nadu) were prioritized for development and implementation of the Protocol for sustainable harvesting under CCF-II project. The protocols for another six species that are included in the demand supply study were implemented through another project funded by Forest Research Project (FRP) under Department for International Development (DFID) and this compliments the CCF II project objectives.
- A draft manual on nursery and propagation techniques of prioritized species has been prepared.

- Collection and marketing of prioritized species completed (2<sup>nd</sup> harvest season) for sustainably harvested species.
- Data collected from eight Bio-geographic zones in India to assess contribution of medicinal plants and traditional knowledge to health and livelihood security of rural people. Data entry and Data analysis are under progress. A report has been prepared on Protection of IPR related to Traditional Health Care Knowledge and Resources in India.
- Five hundred Community Knowledge Registers (CKRs) have been prepared for the States of Andhra Pradesh, West Bengal, Rajasthan, Maharashtra and Orissa. Village level CKRs have been prepared in local language, documenting the resources, practitioners and use pattern.
- 50,415 Home Herbal Gardens (HHGs) in the States of Andhra Pradesh, West Bengal, Rajasthan, Maharashtra and Orissa have been established to cater to the traditional knowledge and primary health care.
- An Assessment of Livelihood through nursery related enterprises was carried out in Orissa State. The study reveals reduction in monthly expenditure on health from Rs.730-1025 to Rs.30 – Rs.50 per three months.
- Twenty Primary Health Care Centres (PHCs) and five Government Ayurvedic Dispensaries have been equipped for delivering health care through Traditional Knowledge documentation in the State of Karnataka.
- A series of interactive workshops were organized with schools. Modules have been prepared in the form of interactive CD for introducing Traditional Knowledge curriculum in school and medical education. Testing of CDs has been carried out in seven schools.
- Training programmes on legal frameworks and preparation of business plans to establish community owned enterprises for Forest Development Agencies (FDA) were organized. Twenty nine potential FDAs from nine project states were nominated by the respective State Forest Departments.
- Digitized database (in CD) on medicinal plants of Orissa and Rajasthan were released.
- Home Doctors websites in six languages like Kannada, Malayalam, Hindi, Marathi, Bengali and English is complete and has been hosted for public viewing.
- Twenty three capacity building programmes have been organized for six hundred thirty participants from nine implementing states on different project components.
- Two visits under the South-South Cooperation component were organized during 23<sup>rd</sup>-31<sup>st</sup> July, 2008 and 25<sup>th</sup>-30<sup>th</sup> October, 2009 to Kenya and South Africa respectively. The visiting teams identified areas of mutual cooperation for conservation and sustainable use of medicinal plants.

### UNDP-GOI-GEF Project on Mainstreaming Conservation and Sustainable use of Medicinal Plant Bio Diversity in three Indian States

Encouraged with the success of this phase, the Ministry with the support of UNDP and Global Environment Facility (GEF) has launched another project namely GOI-GEF-

UNDP Project on 'Mainstreaming Conservation and Sustainable Use of Medicinal Plant Biodiversity in three Indian States' in the States of Chhattisgarh in Central India, Arunachal Pradesh in North-East India and Uttarakhand in North-west India. These States provide a broad range of ecological conditions, and hence medicinal plant diversity as well as range of Institutional arrangements relating to forest management. The total outlay of the project is US \$ 11,414,121 with 4.93 million \$ of GEF and 6.4 Million \$ of Government contribution which makes it Rs. 57.07 Crores as the total cost of the project. The project is for seven years.

The Project is an extension of the CCF II project with main thrust of mainstreaming the long-term conservation, sustainable and equitable use of medicinal plant diversity and associated traditional knowledge with local people into forest management policy and practices at the National, State and Local levels.

The project was launched through an Inception Workshop on 9<sup>th</sup> September 2008 in the Ministry. The project was launched in the State of Uttarakhand through a Brainstorming Session held at Dehradun on 27<sup>th</sup> September 2008. The State of Chhattisgarh and Arunachal Pradesh have also launched the project in their States on 17<sup>th</sup> January 2009 and 27<sup>th</sup> February 2009 respectively. The Joint Secretary, CS-III Division



Fig-16. *Rhododendron arboretum*, a highly ornamental species, used in treatment of headaches

has been designated as the National Project Director (NPD) for the Project. The project shall be implemented in the States by State Forests Departments through State Medicinal Plant Boards (SMPBs). The Project shall be overseen by the National and State Level Steering Committees which have already been constituted. The States have also establishment Project Management Units (PMUs) in their States. FRLHT, Bengaluru has been designated as the National Project Management Unit (NPMU). Requisite MOU has been signed between Government and FRLHT and some staff for the PMU has been recruited. Some of the activities carried out under the project are as follows:

- PMUs have been set up in all the states and staff has been recruited.
- Activities for establishment of Medicinal Plants Conservation Areas (MPCAs) have been initiated. Seven MPCAs in each of the three implementing states are

demarcated in as per the standard models. Base line Data collection has been initiated.

- Policy Review meetings were organized in all the three states by the nodal agencies for carrying out the activities of Outcome 2.
- National Level meeting was organized to work out the modalities for carrying out the studies for Outcome 1. Sub-groups have been constituted on each of the seven Outputs to work out the Terms of References.
- Orientation workshop has been organized to discuss and orient the implementing partners towards a common knowledge and understanding and to prepare future action plan.
- One, reorientation training was given to the Project Staff of Arunachal Pradesh by FRLHT imparting knowledge as a part of capacity building of State Medicinal Plant Board.

### Forest Conservation

#### Objective



The mandate of the Forest Conservation Division is to implement the Forest (Conservation) Act, 1980, which was enacted on 25<sup>th</sup> October, 1980. This Act deals with grant of forestry clearances for diversion of forest lands for non-forestry purposes in respect of development projects like power, roads, railways, irrigation, mining, schools, defence, drinking water, resettlement & rehabilitation of people etc. This Act is regulatory in nature, not prohibitory.

#### Procedure for obtaining prior approval for diversion of forest land (forest clearance)

The State/UT Government before diverting / de-reserving forest land for non-forest purposes requires prior approval of Central Government under section-2 of the Forest (Conservation) Act 1980.

1. The statute for forest diversion requires the diversion in two stages. In Stage-I (i.e. 'in-principle approval'), the proposal is either agreed to or rejected. If agreed to, certain conditions largely relating to depositing the opportunity cost of forest land such as Net Present Value (NPV), Compensatory Afforestation (CA) and other expenses towards mitigating the environmental damages (Catchment Area Treatment, Wildlife preservation, Bio-diversity conservation and rehabilitation of displaced persons, if any) have to be fulfilled by the project authorities. Once this is done, Stage-II clearance is accorded by the Government. Following this the project authorities are handed over the forest land for use.
2. The process of forest clearance may be summarized as below:
  - (i) The proposal is submitted by the concerned State / Union Territory Government seeking prior approval of the Central Government (Ministry of Environment and Forests).
  - (ii) Proposals involving more than 40 ha of forest land are sent to the Ministry of Environment and Forests at New Delhi.

- (iii) Proposals involving forest land up to 40 ha are sent to the concerned Regional Offices of the Ministry of Environment and Forests. These offices are situated at Shillong, Lucknow, Chandigarh, Bhopal, Bhubaneswar and Bangalore.
- (iv) In the Ministry of Environment and Forests at New Delhi, the proposal is examined by the Forest Advisory Committee (FAC) constituted under Section-3 of the Forest (Conservation) Act, 1980. The decision is taken by the Competent Authority (MEF) on the basis of the recommendations of the Forest Advisory Committee. On receipt of the compliance report from the State Government, these are scrutinized by the concerned AIG and thereafter, with the approval of the IGF, final approval to the proposal is conveyed to the State Government.
- (v) In the Regional Offices of the Ministry, the proposals are examined by the State Advisory Group (SAG) pertaining to the concerned State / Union Territory. The recommendations of the SAG are processed in the regional office and note is prepared to obtain the approval of MEF through the Additional DGF, MoEF. Once the approval of the MEF is available on the file, formal order is issued by the concerned Regional Office of the Ministry.
- (vi) The Regional Chief Conservator of Forests, who heads the Regional Office, has been empowered to take decision for the proposals involving forest land up to 5.00 (five) ha except the proposals related to mining and regularization of encroachment.
- (vii) All proposals for regularization of encroachment are dealt with in the Ministry of Environment and Forests at New Delhi irrespective of the area involved.
3. According to the Forest (Conservation) Rules, 2003 which are currently in force, the time lines prescribed for different levels are as follows –
- (i) After receipt of renewal proposals, in the prescribed format and complete in all respects, from the User Agency, 60 (sixty) days for State / Union Territory Government.
- (ii) After receipt of fresh proposals, in the prescribed format and complete in all respects, from the User Agency, 90 (ninety) days for State / Union Territory Government.
- (iii) After receipt of the proposals recommended for approval from the State / Union Territory Government, 60 (sixty) days for the Central Government to take a decision.
4. The Hon'ble Supreme Court of India vide its various orders as given below, directed the Central Govt. to follow certain procedure for according forest clearance:
- (i) Vide its order dated 13-11-2000 in W.P.(Civil) No. 337 of 1995, the Supreme Court of India have *banned de-reservation of forests/ Sanctuaries/ National Parks* except with the approval of the Supreme Court.

- (ii) The Ministry of Environment and Forests moved the Supreme Court of India for deletion of the word "forests" from the above order dated 13-11-2000 in WP(C) No. 337 of 1995 through an Interlocutory Application No. 16. However, the Supreme Court of India on 09-02-2004 disallowed the request of the Ministry stating that *"We see no ground to allow the application and delete the word "forests" from the order dated 13<sup>th</sup> November. The application is accordingly dismissed."*
- (iii) The Hon'ble Supreme Court of India vide its order dated 23-11-2001 in I.A. No.703 in W.P.(Civil) No. 202 of 1995, the Supreme Court of India have *restrained the Union of India from permitting regularisation of any encroachments whatsoever* without their approval.
5. At present, the proposals involving forest land up to 40 ha are being processed and accorded forest clearance as per existing provisions of Forest (Conservation) Act, 1980 without being placed before the FAC.
6. It has been noted that the proposals up to 40 ha of forest lands get sanction by and large within the stipulated time period as mentioned in para-3 above.
7. There is also a general power given to the State Governments for according approval up to 1.00 ha of forest land for non-forest purposes for social sector developmental projects executed by the Government agencies. These are also covered under the Scheduled Tribe and other traditional forest Dwellers (Recognition of forest Rights) Act, 2006.
8. In addition to the above, there is general approval under Section – 2 of Forest (Conservation) Act 1980 for diversion of forest land for underground laying of optical fiber cables, underground laying of telephone lines and underground laying of drinking water supply pipelines.

#### Existing system for clearances in Protected Areas

Directions of Hon'ble Supreme Court in Writ petition (Civil) No. 337/1995 dated 13th November 2000 and 9th May 2002:

Order of Hon'ble Supreme Court dated 13.11.2000 directs "No dereservation / denotification of National Parks/Wildlife Sanctuaries shall be effected".

Order of Hon'ble Supreme Court dated 9.5.2002 directs that "All cases pertaining to Section 29 of the Wildlife (Protection) Act, 1972 shall be referred to the Standing Committee of NBWL".

#### Provisions of the Wildlife (Protection) Act, 1972

Section 29 of the Wildlife (Protection) Act, 1972 provides that ' no person shall destroy, exploit or remove any wild life including forest produce from a sanctuary or destroy or damage or divert the habitat of any wild animal by any act whatsoever or divert, stop or enhance the flow of water into or outside the sanctuary, except under and in accordance with a permit granted by the Chief Wildlife Warden, and no such permit shall be granted unless the State Government being satisfied in consultation with the Board that such removal of Wildlife from the

sanctuary or the change in the flow of water into or outside the sanctuary is necessary for the improvement and better management of wildlife therein, authorizes the issue of such permit.

Section 35(6) of the Wildlife (Protection) Act, 1972 provides that 'no person shall destroy, exploit or remove any wild life including forest produce from a National Park or destroy or damage or divert the habitat of any wild animal by any act whatsoever or divert, stop or enhance the flow of water into or outside the National Park, except under and in accordance with a permit granted by the Chief Wildlife Warden, and no such permit shall be granted unless the State Government being satisfied in consultation with the National Board that such removal of Wildlife from the National Park or the change in the flow of water into or outside the National Park is necessary for the improvement and better management of wildlife therein, authorizes the issue of such permit.

Section 26A (2) of the Wildlife (Protection) Act, 1972 provides that 'No alteration of the boundaries of Sanctuary shall be made by the State Government except on a recommendation of the National Board.

Section 35(5) of the Wildlife (Protection) Act, 1972 provides that 'No alteration of the boundaries of National Board shall be made by the State Government except on a recommendation of the National Board.

### Procedure being followed for grant of clearance

The User Agency/Project Proponent is required to submit the proposals in the

prescribed proforma that has been developed by the Ministry of Environment & Forests and is available in the website of the Ministry (<http://envfor.nic.in>).

The prescribed proforma has five parts and each part to be filled in by the User Agency; concerned Divisional Forest Officer/ Park Manager; Concerned Chief Conservator of Forest; Concerned Chief Wildlife Warden and the Concerned Forest Secretary.

The proforma also seeks information on the detailed biodiversity aspects of the area in question; maps of the area, other activities already in place; possible impacts of the proposal, etc.

The User agency is required to submit the duly filled in Part-I of the proforma and submit it to the concerned Forest Officer, who in turn, forwards through the Chief Conservator of Forest to the Chief Wildlife Warden.

The Chief Wildlife Warden, after giving his specific comments on the proposal forwards the proposal to the Government of India, through the concerned Forest Secretary after the recommendation of the State Board for Wildlife

The proposal so received from the State Government is placed before the Standing Committee of NBWL (Chaired by the Hon'ble Minister for E&F and the Addl. DGF (WL) being the Member-Secretary and having 10 members including Non Government members).

The meetings of the Standing Committee are convened once in 2-3 months time period. During the meetings, discussions on each proposal takes place wherein the

concerned Chief Wildlife Warden and representatives of User Agency are also invited.

In cases where the area proposed for diversion is large and/or the impact of the project on wildlife is grave, site inspections are conducted by the members of the Committee. The site inspection reports are generally considered in the next ensuing meeting of the Standing Committee.

In other cases, where the diversion of land is small and/or the impact of the project on the wildlife is not so visible, the Standing Committee takes a view during the meetings as and when the proposals are considered.

After the recommendations of the Standing Committee of NBWL, the User Agency/State Government have to approach Hon'ble Supreme Court for final clearance in view of their orders dated 13.11.2000 .

It may be mentioned here that the Ministry of Environment & Forests has also filed an Interlocutory Application before the Hon'ble Supreme Court seeking a relaxation of the order of Hon'ble Supreme Court dated 13.11.2000.

### Initiatives by the MoEF

With a view to expedite the prior approval under the Forest (Conservation) Act, 1980, and also clearance under the Wildlife (Protection) Act, 1972, following initiatives have been taken by the MoEF:

#### A. For Border roads along the Indo-China Border/Projects of National Security importance

- Reduced the processing time from 90 days to 30 days at the State Government level

and from 60 days to 30 days at the Central Government level.

- The Regional; Offices of the Ministry were directed to assist/ help the officials of the Border Roads in formulating the proposals as and when these officers approach them.
- The Chief Secretaries of all the States/UTs including these 5 States have been requested to direct the concerned officers handling the proposals including the Nodal Officer (FCA) to expedite processing of proposals.
- The State Governments have been requested to strengthen the institution of the Nodal Officer (FCA) so that only complete proposals in all respect are forwarded by them to the Central Government. And thus, these do not attract further clarifications from the State Government.
- The concerned State/UT Governments have been requested to advise the Divisional Commissioners for coordinating such proposals at the State Government level so that delays are curtailed.
- The workshops/seminars have been organised at Shillong and Dehradun to share information on project/proposal formulation to the officers of BRO / BRTF etc.

#### B. Investigative Survey / Prospecting

Prospecting of any Mineral, done under prospecting license granted under MMRD Act, which requires collection / removal of samples from the forest land, would be a stage between survey & investigation and grant of mining lease and as such



permission under Forest (Conservation) Act, 1980 would be required. However, in case of metallic ores - test drilling up to 20-25 boreholes of maximum 4" dia per 10 sq km and in case of coal and lignite (non-metallic Ores) – (a) test drilling up to 15 boreholes of maximum 4" dia per 10 sq km for open cast mining; and (b) test drilling up to 20 boreholes of maximum 4" dia per 10 sq km for underground mining for prospecting exploration or reconnaissance operations, without felling of trees, shall not attract the provisions of the Act. In all other cases involving more number of drilling of bore holes, prior permission of Central Government under the Act would be required”.

### C. Other Initiatives

- The FAC has been advised to dispose of the minutes of the meeting within two days from the date of receipt of the draft minutes from the concerned officials and indicate their approval / corrections, if any, by email.
- All efforts should be made to finalise the minutes of the meeting within a period of 5 days from the date of convening of the meeting of the FAC.
- The minutes should be processed on the individual case files by the processing officer within two days from the date of receipt of confirmed minutes.
- The approval of the competent authority on the recommendations of the FAC should be communicated to the concerned State/ UT Government within 15 days from the date of convening of the FAC meeting.

### Transparency in processing of clearances

With a view to make the process of environmental and forestry clearances, the information required by the Project Proponent, State/UT Governments and NGOs etc. has been put into public domain by putting the data on the website of the Ministry. The data is being updated at a frequency of ones every week.

The design of the website has been modified to make it more user friendly.

### Activities undertaken

- During 1<sup>st</sup> January, 2009 to 31<sup>st</sup> December, 2009, about one thousand nine hundred sixty nine developmental projects involving about 33,187.20 hectares forest areas have been granted forestry clearance. However, the first stage approval has been given only for eight hundred thirty six proposals involving 15185.90 ha. These include the projects for power generation, irrigation, construction of roads, railway lines, transmission lines, drinking water supply projects, village electricity, schools, hospitals etc.
- During this period, one hundred seventy one proposals were closed / rejected / returned / withdrawn owing to shortcomings from the established/requisite requirements for granting forestry clearance under the Forest (Conservation) Act, 1980.
- Further, to boost the development of underdeveloped area including tribal areas, general approval under Section-2 of the Forest (Conservation) Act, 1980 has been accorded for underground laying of electric cable and wires to individual household,

drinking water supply/water pipelines, telephone lines which involve felling of trees not exceeding fifty numbers per project and are outside the National Parks and Sanctuaries and are laid along the road and validity of the general approval has been extended till further orders.

- Good practices have been adopted to ensure transparency in the system of forestry clearances. Monitoring mechanism for Forest Clearances has been strengthened. Agenda items for Forest Advisory Committee Meetings, its minutes, important guidelines and modifications are being regularly placed and updated on Ministry's website. The Status of all cases received in the ministry are regularly monitored. These all information have been placed in the Public domain.
- During the period, PMO references (twenty seven) and VIP references (sixty seven) have been accorded special attention and almost all of them have been processed and replied with.
- During the period, in order to operationalize CAMPA, Guidelines in conformity with Supreme Court's directions and as per consultation with the State Government was prepared and circulated to all State/UTs. Most of the State have constituted State Level Compensatory Afforestation Fund Management and Planning Authority (CAMPA) in accordance with the guideline and have opened the State CAMPA account. Taking into account the need to commence Compensatory Afforestation in the States/UTs without further loss of any planting season, already 10% of fund remitted by the State Government to the

Ad-hoc CAMPA by the respective State Government have been released to the respective States/UTs.

- National Compensatory Afforestation Fund Management and Planning Authority (CAMPA) Advisory Council was constituted to facilitate the working of State CAMPA. It has already started its working with its first meeting on 29<sup>th</sup> September, 2009. A new initiative in the form of GPS based monitoring system has been envisaged firstly for CAMPA work and later on for other works like monitoring of different conditions stipulated in Forest and environmental clearances, different programmes of NAEB etc. To achieve above objective, a Core Group has been constituted and it will be submitting their road map and plan by March, 2010.

### Strengthening of Forests Division

#### Introduction

The Ministry has six Regional Offices located at Bangalore, Bhopal, Bhubaneswar, Lucknow, Shillong and Chandigarh with its Headquarter in the Ministry at New Delhi. List of the Regional Offices is given in Annexure-II A. The primary function of the Regional Offices is to monitor and evaluate the ongoing forestry projects and schemes with specific emphasis on conservation of forests and follow up action on the implementation of conditions and safeguards laid down by the Ministry while granting clearance to development projects under Forest (Conservation) Act, 1980 and Environment (Protection) Act, 1986.

These Regional Offices were created in mid part 80s. Since then the work load

has increased many fold. However, the strength of both scientific and non-scientific officials and staff in these Offices remained stagnant. Further, over a period of time a number of scientific and ministerial staff have since superannuated and these vacancies remain unfilled. There is a fear that a number of sanctioned posts may have been deemed abolished. It is, therefore, necessary that the staff and officers position in these Regional Offices is reviewed and revised upward.

There have been requests by atleast two States viz. the Uttarakhand and Jharkhand to open additional Regional Offices in these two States so that the smaller proposals requiring prior approval under the Forest (Conservation) Act, 1980 could be finalized expeditiously through the mechanism of State Advisory Group (SAG).

#### Progress of Activities undertaken

The Regional Chief Conservator of Forests is empowered for approval of diversion of forest land for non-forestry purposes upto the extent of five hectare (except mining and

regularization of encroachment) and to process cases between five hectare to forty hectare in consultation with the State Advisory Committee and to undertake physical inspection of sites in cases of diversion of forest lands to non-forestry purposes involving an area of more than one hundred hectare. A statement showing the number of cases received and number of cases cleared under the Forest (Conservation) Act, 1980 during the year 2009-10 (upto 31 December, 2009) is given in Table-7.

#### Other Activities undertaken

Some of the important activities undertaken/ meetings held by the Regional Offices are as follows:

- Due to special management efforts of Regional Office, Eastern Region, Bhubaneswar, State Governments have recently started notifying the non-forest land received against forest diversion proposal since 1980. Orissa Government has notified forty, Jharkhand Government has notified thirteen such pieces of land as Protected Forests and process has been

2

Table-7. Statement showing the number of cases received and number of cases cleared under the Forest (Conservation) Act, 1980 during the year 2009-10 (upto 31 December, 2009)

S.No.	Regional Offices	Number of cases received	Number of cases cleared (upto 31.12.2009)
1.	Bangalore	75	55
2.	Bhubaneswar	52	62
3.	Bhopal	168	86
4.	Lucknow	390	495
5.	Shillong	72	98
6.	Chandigarh	439	370
<b>Total</b>		<b>1196</b>	<b>1166</b>

- 
- expedited in West Bengal and Andaman & Nicobar Islands.
- Regional Office, Eastern Region, Bhubaneswar has initiated mandatory GPS mapping for boundary demarcation of diverted forest land and compensatory afforestation land for better identification, management and control against any mismanagement/ mis-utilisation.
  - A special drive has been made by the Regional Office, Eastern Region, Bhubaneswar for initiation/ revision of Working Plans as per National Working Plan Code. Regional Office, Eastern Region, Bhubaneswar has also stressed for focused attention towards Non Timber Forest Produce (NTFP) Management of all the Eastern States.
  - To develop expertise in different categories of the projects that have been accorded environmental clearance by the Ministry of Environment & Forests, the Regional Office, Eastern Region, Bhubaneswar has identified different sectors such as Aluminium & Bauxite sector, Thermal Power Projects, Coal Mine Project sector, Oil, Gas & Petroleum sector, Steel & Sponge Iron sector and Nodal scientists have been nominated for each sector. The concerned scientists are encouraged to specialize in each of the allotted sectors.
  - Till December 2009, three Sector Specific Interactive meetings were organised by the Regional Office, Eastern Region, Bhubaneswar. These meetings were held on 31.7.2009 (Aluminium & Bauxite sector), 23.10.2009 (Thermal Power Projects sector) and 8.12.2009 (Oil, Gas & Petroleum Projects sector). These meetings were attended by Heads of Departments and senior level executives of major projects as well as professors/ academicians involved in research from leading institutions such as IIT Kharagpur, IIT Guwahati, NIT Rourkela, NIT Durgapur, VSS University of Tech., Burla, IT-BHU, CMRI and DGMS. The objectives of the meetings to have Industry-Institution interface discussion are (a) experience sharing among the participating projects on the best practices adopted, (b) the institutions can understand directly from the industry the R&D needs and (c) the industry can understand the strengths and capabilities of the best Research Institutes of the Eastern Region.
  - The Regional Office, Eastern Region, Bhubaneswar has assisted the industries for management of their solid wastes. The industries generating wastes (Tyre, Petroleum and Aluminium Smelter), and Eastern Railway made an inventory of their solid wastes for their chemical constitutions and caloric value which helped the Regional Office to involve Alternative Fuel & Raw Materials (AFR) Division of M/s ACC and IIT Kharagpur to explore the possibility of utilisation of wastes than sending to Treatment, Storage and Disposal Facility.
  - A small garden dedicated to indigenous fragrant plants is being developed in the office complex of the Regional Office, Eastern Region.
  - Vermi-composting facility has been developed in the campus of the Regional Office, Eastern Region utilising the domestic wastes. The manure generated from the vermin-composting will be used in the garden.
- 

- Regional Office, North Eastern Region, Shillong organized interactive meeting of project proponents, State Forest Departments, Pollution Control Boards on 3 March 2009 related with status of compliance of projects approved under EPA, 1986. The meeting was chaired by Additional Secretary, Ministry of Environment & Forests.
- Regional Office, North Eastern Region, Shillong organized a sectoral meeting relating to Cement Industry on 16.11.2009

### Financial Achievement

A statement showing financial targets and achievements for the year 2009-10 is given in Table-8.

### Intensification of Forest Management Scheme (IFMS)

While aiming to expand forest cover in the country it is equally important to improve the state of existing forests and protect them against various threats. This Centrally Sponsored Intensification of Forest Management Scheme aims at strengthening forest protection machinery of the State/UT Governments and providing support for area-specific forest management interventions. The financial assistance is provided on cost share basis – All the North

Eastern States including Sikkim and special categories States namely Jammu & Kashmir, Himachal Pradesh and Uttarakhand share 10% of the cost while the rest of the States/UTs share 25% of the cost of the annual plans of operations.

The major components of the scheme include:

- Forest Fire control and Management.
- Strengthening of Infrastructure.
- Survey, Demarcation and Working Plan preparation.
- Protection and Conservation of Sacred Groves.
- Conservation and Restoration of Unique Vegetation & Ecosystems.
- Control and Eradication of Forest Invasive Species.
- Preparedness for Meeting Challenges of Bamboo Flowering and Improving Management of Bamboo Forest.

While the first three components have been under implementation since the X Plan period under the erstwhile Integrated Forest Protection Scheme, the remaining four components have been introduced from the year 2009-10.

Table-8. Financial targets and achievements for 2009-10

(Rs. in crore)

Revenue head			Capital head		
Target		Achievement (upto 31.12.2009)	Target		Achievement (upto 31.12.2009)
Budget Estimates	Revised Estimates		Budget Estimates	Revised Estimates	
7.83	10.37	6.93	3.50	4.03	4.03

The scheme has helped the State/UT forest departments in modernising the forestry sector by way of creating infrastructure such as field offices, forest stations, residential facilities for frontline staff; construction of roads and patrolling paths; introduction of modern technology including use of PDS for field surveillance and reporting; providing field vehicles, arms and ammunitions. Introduction of advanced technology helped in bridging the backlog in preparation of working plans. Forest fire control has become progressively effective by way of creation and maintenance of firelines for prevention of forest fires, early detection, reporting and quick mobilisation of force for forest fire control. Modern technology has also helped in improving planning for forest fire control and management.

This scheme has also provided incentives for involvement of local people through Joint Forest Management Committees in forest protection. Presently, there are more than one lakh JFMCs managing an extent of twenty two mha involving twenty two million people of forest area.

The XI plan outlay for the scheme is Rs.600.00 crores. The allocation for the year 2009-10 is Rs.76.00 crores.



### Forest Policy

Forest Policy Division of Ministry of Environment & Forests (MoEF) coordinates the National Forest Policy and its implementation issues, Forest International Cooperation besides examining and coordinating the State Forest Policies, State Forest Acts/Amendments etc. The details of the major activities coordinated by the Forest Policy Division are as follows:

### National Conference of Ministers of Environment and Forests

The National Conference of Ministers of Environment and Forests was held on 18<sup>th</sup> August, 2009 at Vigyan Bhawan, New Delhi. The aim of the Conference was to enhance cooperation and identify concrete actions in priority areas for protecting the environment and forests. The Conference was inaugurated by the Prime Minister. It was attended by Deputy Chairman, Planning Commission, Union Ministers, Chief Ministers, Ministers of Environment and Forests, States/UTs Secretaries of Environment and Forests, Principal Chief Conservators of Forests, Chief Wildlife Wardens, Resident Commissioners, Chairmen and Member Secretaries of Central Pollution Control Board (CPCB) and State Pollution Control Board (SPCB), senior officers from Central Ministries and State/ UTs, NGOs, officers from various Institutions of Ministry of Environment and Forests (MoEF), etc. The administrator of Chandigarh (Governor) Punjab and Lt. Governor of Andaman and Nicobar Islands also participated in the Conference.

In the Inaugural Session the Minister of State (Independent Charge) for Environment and Forests, Shri Jairam Ramesh gave the Welcome Address and Opening remarks. He highlighted the following issues:

- Environmental Management – Strengthening compliance and monitoring of standards
- Cleaning/ conservation of Rivers and lakes
- Accelerating the pace of greening and improving the quality of forest cover
- Modernisation of Forestry administration



Fig-17. Hon'ble MoS(I/C) delivering speech during National Conference of Ministers of Environment and Forests

2

- Relationship between the Forest (Conservation) Act and 'The Scheduled Tribes and Other Traditional Forest Dwellers (Recognition of Forest Rights) Act, 2006
- Wildlife Management, particularly Project Tiger
- The proposed creation of Environment Protection Authority and National Green Tribunal Act
- Increase the resources for forests conservation and improving the quality of forest
- Release of CAMPA funds to States
- Better funding for environmental activities like Common Effluent Treatment Plants
- Re-imburement of water cess to State Governments

The Prime Minister in his Inaugural Address urged the State Governments:

- To create State level action plans for climate change consistent with the strategies in the national plans.
- To modernize the existing Forest and Wildlife management system in the country with improved resources, communication and improved training of personnel.
- To fill positions of front line personnel lying vacant at State level.
- To reserve the degradation of rivers of our country and set up institutional structures for synergizing the river conservation efforts at the national and state levels.
- To effectively enforce legal provisions through State Pollution Control Boards to

curtail the discharge of untreated industrial effluents that account for nearly 25% of the total pollution load in our river systems.

- To involve more stakeholders, particularly youth, to lead the movement for environmental protection and regeneration.
- To use collective knowledge and wisdom and experience to seek new pathways to reserve the environmental degradation and resource depletion.

The Minister of State (Independent Charge) for Environment and Forests, Shri Jairam Ramesh during the Working Session recalled the detailed discussions held in the preparatory meeting on 17<sup>th</sup> August, 2009. In the Working Session, agenda-wise presentations deliberations and decisions took place as per details:

### The Scheduled Tribes and other Traditional Forest Dwellers (Recognition of Forest Rights) Act, 2006

The Ministry has been pro-actively involved, in coordinating the Implementation

of The Scheduled Tribes and Other Traditional Forest Dwellers (Recognition of Forest Rights) Act, 2006 along with Ministry of Tribal Affairs. In the process:

- Instructions issued to state governments on August 3, 2009 that to formulate unconditional proposals under the Forest (Conservation) Act, 1980, the State/UT governments are, wherever the process of settlement of rights under the FRA has been completed or currently under process, required to enclose evidences for having initiated and completed the above process, specially among other sections, 3(1)(i), 3(1)(e) and 4(5).

- To facilitate implementation of the Act, the topic "Protection of Forests in the context of the implementation of The Scheduled Tribes and Other Traditional Forest Dwellers (Recognition of Forest Rights) Act, 2006" was kept as an Agenda for discussion during the National Conference of Ministers of Environment and Forests held on 18<sup>th</sup> August, 2009 at New Delhi where it was emphasized that there should be focus on developing strategies for the speedy implementation of the Tribal Act while minimizing its potentially deleterious impacts on forests.

- In the context of numerous Court Cases challenging the various provisions of the Act, this Ministry is regularly providing Ministry's comments to the Nodal Ministry i.e. Ministry of Tribal Affairs.



Fig-18. Forest dwellers with forest produce



### United Nations Forum on Forests (UNFF)

The United Nations Forum on Forests (UNFF) in its 7<sup>th</sup> Session had adopted the Non-Legally Binding Instrument on all types of forests with the four global objectives. All member countries had agreed to implement this instrument and to make efforts for achieving global objectives. The Government of India is also committed to implementing Sustainable Forest Management (SFM). In this context, the information on progress in 2007-08/ 2008-09 in implementing the Non-Legally Binding Instrument on all Types of Forests (NLBI) and the progress towards achieving the four Global Objectives on Forests was submitted. The 8<sup>th</sup> Session of United Nations Forum on Forests (UNFF) was held in New York, USA from 20<sup>th</sup> April to 1<sup>st</sup> May, 2009. The Indian delegation headed by Director General of Forests and Special Secretary (DGF&SS), Ministry of Environment and Forests, Government of India participated actively in the 8<sup>th</sup> Session of UNFF and suitably put forward the country's views in the meetings.

### World Forestry Congress

The 13<sup>th</sup> Session of World Forestry Congress was held at Buenos Aires, Argentina, from 18<sup>th</sup> to 23<sup>rd</sup> October, 2009. The theme of the Congress was 'Forests in Development – A Vital Balance'. The Indian Delegation headed by DGF&SS participated actively in the 13<sup>th</sup> Session of World Forestry Congress. Meetings/ discussions were held with Mr. Jan Heino, Dy. Director General of FAO Forestry Department and Mr. Olman Serrano, Associate Secretary General World Forestry Congress Forestry Department, FAO, Rome regarding modalities of planning of the

next Congress. On their invitation, the DGF&SS, Dr. P.J. Dilip Kumar made a formal declaration of intention to host the next Congress, in the concluding ceremony held on 23<sup>rd</sup> October, 2009. Discussions were also held with officials of British Forestry Commission, US Forest Service, Chinese delegation, Russian delegation and Nepal team on areas of mutual interest and cooperation.

### Agenda-I : Monitoring compliance with environmental and forestry related laws and regulations and the roadmap for institution - building

A presentation on "Institution Building for Managing our Environment & Forests" was made by Shri Vijai Sharma, Secretary (E&F). The presentation, *inter alia*, highlighted the various dimensions of the environmental challenge and the issues involved in monitoring compliance with environment and forest laws. After detailed deliberations, it was agreed to:-

- Establish an empowered Environment Protection Authority, within a year, which would be an autonomous, professional and science-based body, fully authorized to undertake effective implementation of the legislation and rules therein, as well as monitoring compliance with safeguards stipulated as part of environmental clearances and also to transmit to the States within a month a centrally prepared concept note on the proposed Authority;
- Conduct a survey of the seventeen categories of highly polluting industries in the current year at the State level to ensure compliance of relevant standards and also to document the clean technologies being adopted;



## Ministry of Environment & Forests

---

- Work out a time-bound action programme for handling the industrial clusters having serious environmental pollution levels, to be implemented jointly by the Central and State Pollution Control Boards. For this, the Central Government will issue guidelines for identification of critically polluted areas and the monitoring protocol to be enforced. High level monitoring at the State Level of these areas will be undertaken to ensure timely intervention;
- Undertake a comprehensive inventORIZATION of hazardous waste being generated in different States and UTs;
- Expedite sanctions due under the Water Cess Act by the Central Government to the State Pollution Control Boards (SPCBs), with action to be taken according to a system to be devised to enable disbursements to the SPCBs without delay and also to provide additional resources to the Central Pollution Control Board (CPCB) under the Water Cess Act;
- Strengthen the SPCBs by allocating greater budgetary resources and sanctioning additional posts wherever needed in terms of technical manpower and infrastructure, as a primary responsibility of the State Government. The Central Government will provide assistance to the weaker State PCBs for this endeavour;
- Augment the technical manpower, infrastructure and financial resources of the CPCB;
- Put in place innovative funding mechanisms, public-private partnerships and special purpose vehicles for setting up common facilities, such as Common Effluent Treatment Plants (CETPs), treatment, storage and disposal facilities (TSDFs) for hazardous wastes, and common facilities for treatment of bio-medical wastes, keeping in view the need to substantially enhance the assistance by the Central Government;
- Set up and strengthen, in view of the decentralized appraisal procedures, State-level Environmental Impact Assessment Authorities and Coastal Zone Management Authorities, with professional and technical expertise in the environment and forest related fields, supported by technology-enabled monitoring mechanisms for enhancing environmental compliance;
- Operationalize the crisis management systems to handle chemical accidents and related emergencies, supported by onsite and offsite emergency plans and systems for transmitting information using the web-based Chemical Accident Information and Reporting System. Preparation of emergency plans for the Maximum Hazard (MAH) units will be expedited.
- Modernize and revitalize forest administration at various levels, particularly at the cutting-edge level of forest guards and rangers, including with regard to new recruitment, improvement of working conditions and better incentives for field-level staff. States will endeavour to bring the Forestry personnel on par with the Police Force in terms of remuneration and service conditions.
- Circulate a copy of the National Green Tribunal Bill, 2009. which has been recently introduced in the Parliament, to the States within a week.

**Agenda-II : Improving our approach to river cleaning using innovative models and enhanced coordination between Centre, States and Local Bodies**

A presentation on 'River Cleaning using Innovative Models' was made by Shri R.H. Khwaja, Additional Secretary. The presentation highlighted the recent initiatives of the Government for giving a fresh impetus to river cleaning and underlined the need for enhanced coordination between Centre, States and Local Bodies. After discussions, the following conclusions were arrived at:

- To effectively coordinate the working of the Centre, States and Urban Local Bodies for river and lake cleaning programmes; to significantly enhance the resources allocated for these programmes; and seek bilateral/multilateral assistance for the effort and put in place new implementation mechanisms, e.g., special purpose vehicles, drawing upon the experience gained over the past two decades;
- To set up empowered structures in the States, headed by the respective Chief Ministers; complemented by tripartite Memorandums of Agreement (MoAs) between the MoEF, the State Governments, and the Urban Local Bodies concerned to effectively plan, coordinate and implement river conservation activities in an integrated manner. States will allocate dedicated funds for meeting Operation and Maintenance (O&M) expenses and consider measures for mobilization of resources for this purpose by levy of user charges, cess etc.;
- To put in place innovative funding mechanisms, public-private partnerships and special purpose vehicles for setting up

common facilities, such as common effluent treatment plants (CETPs).

**Agenda-III : Strategies for increasing forest cover and enhancing synergies between 'Green India Mission', National Afforestation Programme and CAMPA funds**

Shri K.B.Thampi, Inspector General of Forests made a presentation highlighting the present status of the Forest and Tree Cover (FTC) in the country, the strategies for increasing FTC, current initiatives and action points. After discussion the following conclusions were reached:

- States would immediately prepare a status paper showing the availability of budgetary resources in the respective states for the Forestry Sector from all sources and send it to the Ministry of Environment of Forests.
- The information required from the states for preparing the Detailed Project Report (DPR) of a Rs. 1600 crores project likely to be supported by JICA should be expedited
- States experiencing difficulties in accessing funds for forestry/afforestation projects under the NREGA may emulate the example set by Andhra Pradesh where the process has been considerably streamlined.
- The Ministry would take necessary action expeditiously on the proposals on Clean Development Mechanism (CDM) that will be forwarded by Madhya Pradesh and other states.

**Agenda-IV : Strengthening of State Forest Departments by Modernization, Infrastructure development and Capacity building of forest officials**

Shri A.K.Johari, Deputy Inspector General of Forests introduced the agenda

through a presentation. After discussions the following Action Points were agreed upon:

- The State/UT Governments would prepare plans for modernising their forestry administration by 20.12.2009 and submit the APOs to the Ministry at the earliest. In this modernisation plan, the focus would be on the frontline forestry forces.
- The State/UT Governments would submit information as per the Proforma enclosed with the agenda note of the Agenda Item No. 4.
- Programme Coordinators for Intensification of Forest Management Scheme would be designated by the State/UT Governments.
- For the areas affected by Naxalism, Divisional Plans would be submitted by the concerned State/UTs at the earliest.

The following conclusions were reached:

- States would undertake modernisation of Forestry Administration on a Mission Mode. Focus of Scheme would be on Frontline Forestry Force. Attempts would be made by the States to bring the Forestry Force on par with the Police Force in terms of their pay, allowances, promotions, etc.
- For areas affected by left wing extremism, the State Governments would apportion funds from the Central Assistance for implementation of Divisional Plans under Strengthening of Forestry Administration.



**Agenda-V : Protection of Forests in the context of the implementation of "The Scheduled Tribes and Other Traditional Forest Dwellers (Recognition of Forest Rights) Act, 2006**

Dr. P.B.Gangopadhyay, Addl. Director General of Forests made a brief presentation

on the subject. It was said that while the Ministry of Tribal Affairs is the Nodal Ministry for the implementation of the Act, the Ministry of Environment & Forests and the State Forests Departments have a facilitating Role. The Minister of State (Independent Charge) for Environment and Forests observed that 'The Scheduled Tribes and Other Traditional Forest Dwellers (Recognition of Forests Rights) Act, 2006' needs to be implemented speedily and that it is the responsibility of all concerned to work in this direction. At the same time, it is also necessary to take necessary steps towards conservation. In the ensuing discussions, the following action points were agreed upon:

- Forest Departments will facilitate the speedy implementation of the Act by providing maps, documents & evidences and by proactively participating in the Sub-division level & District level Committees.
- States will expedite the identification of Critical Wildlife Habitats.
- Forest Departments will prepare Scheme for permanent demarcation of the Right holders' land and request for funding by the Tribal Welfare Departments.
- Forest Departments will prepare proposal for capacity building of forest dwellers so that they can conserve, regenerate, protect and sustainably manage the forests and can live in harmony with their environment. Such programme should be posed for funding by the Tribal Welfare Departments.

**Agenda-VI : Wildlife management including tiger conservation and issues related to man-animal conflict**

At the outset, the MOS (I/C) (E&F) remarked that wildlife conservation in the untry

faces several challenges. Dr. Rajesh Gopal, Member Secretary, National Tiger Conservation Authority made a presentation highlighting the various issues pertaining to wildlife sector. In the ensuing discussion, the following action points were agreed upon:

- State/ UT Governments to make use of the provisions of the modified Centrally Sponsored Schemes in the Wildlife sector and also to scale up financial allocation for wildlife conservation in State Plans.
- Step up intelligence networking and effective enforcement in Protected Areas.
- Promote specialization within Forest Department to improve field delivery.
- Establish a 24 x 7 control room with the Chief Wildlife Warden for interlinking with the Wildlife Crime Control Bureau and field formations. Further, they shall inform the Wildlife Crime Control Bureau on the occurrence of major crimes in a format already circulated and also to give details of wildlife crimes during the last 10 years to facilitate the establishment of wildlife crime data base.
- Operationalise the tripartite MOU at the earliest for availing central assistance under Project Tiger.
- Ensure statutory compliance as required by the NTCA (buffer zoning, Steering Committee, tiger conservation plan, foundation).
- Ensure actions on the recommendations made in the All India tiger estimation report for corridor conservation,
- Prepare and operationalize Management Plans / Tiger Conservation Plans within 6 months, wherever these are nonexistent.
- Fill up frontline staff vacancy through a special drive.
- Ensure safeguards and timely compensation for man-wildlife conflicts in human dominated landscapes for enlisting cooperation of local inhabitants.
- Appoint independent Field Coordinators for each Elephant Reserve in Elephant Range States.
- Wildlife Institute of India to constitute a special team to study the man-animal conflict issues involving Nilgai. The team shall visit the badly affected States submit a report for addressing this issue within 2 months,
- MoEF to convene a separate meeting on issues related to elephant-man conflicts involving Elephant Range States.
- Mobilize local community participation as the primary instrument for protecting wildlife and for promoting conservation and sustainable management of forests;
- Act effectively against poachers and, simultaneously, amend the Wildlife (Protection) Act, 1972 as necessary, to enhance its effectiveness,
- Take concrete steps, with the Centre and States working together, for addressing the special needs of communities living in and around the wildlife habitats, supported by Management Plans for the Protected Areas, which recognize the local communities as stakeholders.

## Wildlife Conservation

### Introduction

The Indian Constitution entails the subject of forests & wildlife in the Concurrent list. The Federal Ministry acts as a guiding

torch dealing with policies and planning on wildlife conservation while the State/ UT Governments have been vested with the responsibility of implementing national policies and plans. Realizing the huge task of conserving India's wildlife resources, the National Wildlife Action Plan (2002-2016) was adopted, emphasizing the need for peoples' participation and support for wildlife conservation.

In Government of India, the Additional Director General of Forests (Wildlife) and Director, Wildlife Preservation is the head of the Wildlife Wing in the Ministry of Environment & Forests. The Wildlife Wing has two Divisions, namely, Project Elephant Division and Wildlife Division, each headed by an officer in the rank of Inspector General of Forests. A Deputy Inspector General of Forest (Wildlife), an Assistant Inspector General of Forests & Joint Director (Wildlife) and one Deputy Director (Wildlife) provide support to the Wildlife Wing. In addition, three autonomous bodies, National Tiger Conservation Authority (NTCA), Central Zoo Authority (CZA) and Wildlife Institute of India (WII) have been constituted for tiger conservation, zoo management, research and training in wildlife respectively under the Ministry. The National Zoological Park in the capital is also a part of the Wildlife Wing of the Ministry of Environment & Forests.

In tune with the 2006 amendment to the Wildlife (Protection) Act, 1972, a Wildlife Crime Control Bureau has been established to combat wildlife related crimes. The Wildlife Crime Control Bureau has five Regional Offices located Delhi, Mumbai, Kolkata, Chennai and Jabalpur and three Sub-regional offices at Amritsar, Guwahati and Cochin.

### Funding Support for Wildlife Conservation

Government of India provides technical and financial support to the State/ UT Governments for wildlife conservation under the various Centrally Sponsored Schemes - *Integrated Development of Wildlife Habitats*, *Project Tiger*, and *Project Elephant*, and also through Central Sector Scheme - *Strengthening of Wildlife Division and Consultancies for Special Tasks*, and through Grants in Aid to the Central Zoo Authority and Wildlife Institute of India, Dehra dun. The objectives and details of the Schemes handled by the Wildlife Division are as given below:

### Integrated Development of Wildlife Habitats

The Protected Area network in India includes ninety nine National Parks and five hundred fifteen Wildlife Sanctuaries, forty three Conservation Reserves and four Community Reserves. The objective of the Scheme is to provide financial and technical assistance to the State/ UTs to conserve wildlife resources. The Scheme supports various activities aimed at the conservation of wildlife that *inter alia* include habitat improvement practices, infrastructure development, eco-development activities, anti poaching activities, research, training, capacity building, census of wildlife, etc.

Under this Scheme, 100% grant is provided for identified items of non-recurring expenditure. Also, 50% assistance is provided in respect of recurring items of expenditure. For areas located in mountainous, coastal, deserts and with identified endangered species, 100% financial support is provided for both recurring and non-recurring items of

work. An amount of Rs 80.00 crore was allocated during the year 2009-10 under the Scheme.

During December 2008, the erstwhile Scheme – ‘Development of National Parks and Sanctuaries’ has been modified by expanding the scope and adding a few more components and activities. The total outlay for the modified Scheme - titled as ‘Integrated Development of Wildlife Habitats’ is Rs.74.00 crores for the 11<sup>th</sup> five Year Plan period. Apart from providing support to Protected Areas (National Parks, Wildlife Sanctuaries, Conservation Reserves and Community Reserves), the modified Scheme also provides for ‘Protection of wildlife outside the Protected Areas’ and ‘Recovery programmes for critically endangered species’.

The Ministry had initiated an independent evaluation of National Parks and Wildlife Sanctuaries by a group of experts to ascertain the Management Effectiveness of Protected Area network in the country. Five regional committees of experts have been constituted for the purpose.

### Recovery programmes for critically endangered species

The Ministry has initially shortlisted fifteen species which are Snow Leopard, Bustard, Dolphin, Hangul, Nilgiri Tahr, Marine turtles, Edible-nest Swiftlet, Asian Wild Buffalo,



Fig-19. Bhadra Wildlife Sanctuary

Nicobar megapode, Manipur Brow-antlered deer, Vultures, Malabar civet, One-horned rhino, Asiatic Lion and Swamp deer. Out of these ‘Recovery Programmes’ for Vulture, Snow Leopard, Hangul, Edible-nest Swiftlet and Manipur Brow Antlered Deer have been launched. Funds have been released to Jammu & Kashmir (Snow leopard and Hangul), Gujarat, Punjab and Haryana (Vulture), Edible-nest Swiftlet (Andaman & Nicobar Islands), Manipur Brow Antlered Deer (Manipur). Apart from this, Government of India has formulated an Action Plan for Vulture Conservation, which is being implemented in collaboration with State/UTs. The Government has supported Vulture Breeding Centres at Pinjore in Haryana, Buxa in West Bengal and Rani Forest in Assam and also the captive breeding centres at 4 Zoos at Bhopal, Bhubaneshwar, Junagarh and Hyderabad, which have been set up through CZA. Government of India also providing funds to Bombay Natural History Society, Mumbai for the project “Monitoring and use of Veterinary

Non-Steroidal Anti-inflammatory drugs (NSAID) and Painkiller and their distribution around select vulture site”

### Strengthening of Wildlife Division and Consultancies for Special Tasks

This Central Sector Scheme was launched in 1986 to strengthen the Wildlife Division in the Ministry and the Regional Officers of Wildlife Preservation for fulfilling the statutory obligations under the Wildlife (Protection) Act, 1972 and the Convention on International Trade in Endangered Species of Wild Fauna and Flora (CITES).

International trade in wild flora and fauna is regulated by the provisions of the EXIM Policy, the Wildlife (Protection) Act, 1972 and CITES convention. The Director (Wildlife Preservation) is designated as the CITES Management Authority and the Regional Deputy Directors (Wildlife Preservation) are the Assistant Management Authorities under CITES. They monitor and regulate international trade in wildlife and its derivatives at the designated ports of exit

and entry. Consequent upon the creation of the Wildlife Crime Control Bureau, these regional and sub-regional offices have been now made part of the Bureau.

The Scheme “Strengthening of Wildlife division and Consultancies for Special Task” provided assistance to the Regional Offices located in Delhi, Mumbai, Kolkata, Jabalpur and Chennai for manpower and development of infrastructure. Assistance was also extended to the three sub-regional offices at Guwahati, Amritsar and Cochin. In addition, the Scheme also supported the functioning of the Wildlife Division in the Ministry. The allocation of the scheme during the year 2009-10 was Rs.4.08 Crores.

The Scheme also supported wildlife research activities/ projects envisaged in the National Wildlife Action Plan (2002-2016). Grant were also provide to research institutes, universities, NGOs and other organizations of repute engaged in wildlife research both at the field and laboratory levels. Major areas supported *inter alia* include taxonomy, population estimation, wildlife conservation & management, restoration of degraded ecosystems, etc. About twenty three projects in various disciplines of wildlife management are under various stages of consideration/ implementation

### Wildlife Crime Control Bureau

The Wildlife Crime Control Bureau (WCCB) has come into existence on 6/6/2007 after amending



Fig-20. Rhinoceros – needs conservation and protection



Wildlife (Protection) Act, 1972 in 2006. The mandate of WCCB includes collection, collation of intelligence and its dissemination, establishment of a centralized wildlife crime databank, coordination of the actions of various enforcement authorities towards the implementation of the provisions of the Act, implementation of the international conventions, capacity building for scientific and professional investigation, assistance to authorities in other countries for a coordinated universal action towards control of wildlife crimes and to advise the government regarding various policy and legal requirements.

The Bureau at present is manned by forty four officials including one Addl. Director in the rank of Inspector General of Police. As a central agency, it is assisting the state agencies through intelligence inputs, analysis of information and providing expertise. The Bureau has also performing its role at the exit points under CITES. This organization has also played an active role in pursuing the interstate linkages in some important seizures of mega-fauna. The Bureau has issued alerts on trafficking in some species and advisories on collection and appreciation of forensic evidence.

### Standing Committee of National Board for Wildlife

The Standing Committee of National Board for Wildlife, was constituted on 9th July 2007 for a period of three years. The Standing Committee is chaired by the Hon'ble Minister of Environment & Forests and is comprised of ten members including official and non official members. The Standing Committee has been delegated the powers

by the National Board for Wildlife for framing policies for effective wildlife conservation, making recommendations on wildlife conservation, etc. The Standing Committee ordinarily meets once in three months. During the period from 1st April 2009 till date, 4 meetings of the Standing Committee of National Board for Wildlife were held under the Chairmanship of Hon'ble Minister of State for Environment & Forests. The meetings were held on 4th May 2009, 17th July 2009 and 16th September 2009 and 22nd December 2009. During these meetings, several important matters regarding wildlife conservation and also various proposals relating to development works involving Protected Areas were considered. In all, fifty five proposals were considered by the Standing Committee during these 4 meetings, alongwith other important issues related to wildlife conservation. The minutes of the meetings are regularly updated to the official website of the Ministry.

### International Cooperation

India is a party to five major international conventions related to wildlife conservation, viz. Convention on International Trade in Endangered Species of wild fauna and flora (CITES), International Union for Conservation of Nature and Natural Resources (IUCN), International Whaling Commission (IWC), United Nations Educational, Scientific & Cultural Organization-World Heritage Committee (UNESCO-WHC) and the Convention on Migratory Species (CMS).

During the reporting period, i.e. 2009-2010, India was actively involved in the following International Conventions:



Fig-21. Black-tailed Godwit (*Limosa limosa*)

– **Convention on International Trade in Endangered Species of Fauna and Flora (CITES)**

In order to regulate international trade in endangered species of wildlife, the Convention on International Trade in Endangered Species of wild fauna and flora (CITES) was signed in March 1973. The Government of India signed the Convention in July 1976, which was ratified in October 1976. The Director, Wildlife Preservation has been designated as the CITES Management Authority for India. India also represented in the Animal Committee meeting of CITES held at Geneva during April 2009.

– **World Heritage Convention**

India is a member of World Heritage Convention responsible for listing of World Heritage Sites, which include both Cultural and natural sites. The World Heritage Convention is a Convention under the aegis of the United Nations Educational, Scientific

& Cultural Organization (UNESCO). Wildlife wing of the Ministry of Environment & Forests is associated with conservation of the Natural World Heritage sites. Currently, five natural World Heritage Sites have been recognized by UNESCO in India viz, Nanda Devi National Park, Kaziranga National Park, Manas National Park, Keoladeo National Park and Sundarbans National Park,

apart from these, the Valley of Flowers National Park has also been included in the list of World Heritage Sites as an extension to Nanda Devi National Park. Four new natural heritage sites viz, Western Ghats cluster, Kangchendzonga National Park, Namdhapha National Park and Wild Ass Sanctuary, Little Rann of Kutch have been included in the tentative list of World Heritage Sites. The Ministry of Environment & Forests has forwarded the detailed nomination dossiers for listing of Western Ghats Cluster Sites to the World Heritage Sites, to the UNESCO.

India had represented in the 33<sup>rd</sup> Session of the World Heritage Committee that was held at Seville, Spain from 22<sup>nd</sup> to 30<sup>th</sup> June 2009.

– **International Whaling Commission**

The International Whaling Commission (IWC) was set up under the International Commission for the Regulation of Whaling which was signed in Washington on

2<sup>nd</sup> December 1946. The purpose of the Convention is to provide for conservation of whale stocks. India has been a member of the International Whaling Commission since 1981 and has played a pro-active and prominent role in bringing about a moratorium on commercial whaling and supporting the Commission in its efforts towards whale conservation.

The 61<sup>st</sup> Annual meeting of the International Whaling Commission was held in Madeira, Portugal from 22<sup>nd</sup> to 26<sup>th</sup> June 2009. An Indian delegation attended the meeting. India's proactive role in its efforts to conserve the whale population was appreciated during the meeting.

### – IUCN : World Conservation Union

International Union for Conservation of Nature (IUCN) is a unique global organization which started working in 1948. It is one of the handful of international organization where Governments and non-Governmental bodies work together as parties. By virtue of being a member of IUCN, one has access to the largest network of specialists in the field of conservation. IUCN is having an observer status at the United Nations and advises Governments on matters related to conservation, integrity and diversity of nature and also ensures that any use of natural resources is equitable and ecologically sustainable.

India has a long relationship with IUCN. The Government of India was the first country in South Asia to join IUCN as a state member in 1969. It is also the first and the only country in the region to host the General Assembly of IUCN in 1969. At present there are twenty two members

of IUCN in India including the Ministry of Environment & Forests, National Board for Wildlife, Wildlife Institute of India, Dehradun the Govind Ballabh Pant Institute for Himalayan Studies, Almora and Indian Institute of Forest Management, Bhopal. An IUCN Country Office in India is also functional with its office in New Delhi.

Further, an Indian National Committee (INC) of the IUCN is in existence under the Chairmanship of the Secretary (E&F) and comprising both official and non official members. The Director, Wildlife Institute of India is the Member-Secretary to the INC of IUCN.

### – Indian National Committee of IUCN

During the period 2009-2010, one meeting of the Indian National Committee of the IUCN was convened on 28<sup>th</sup> October 2009 under the Chairmanship of the Secretary (E&F). The important discussions held during the meeting include:

- Presentation on progress on India programme by IUCN India Country Office
- Mechanism for greater involvement of IUCN member organizations in IUCN India Country Programme.
- Presentation of financial statement of INC-IUCN Secretariat.

### IUCN India Country office

The Government of India has been a state member of IUCN since 1969. In 2007, IUCN established a country office and programme in India to deepen its engagement at the local, national, and regional levels. IUCN's India programme

seeks to identify the key environmental concerns and gaps and correspondingly broaden the membership base to enhance influence on policy and practice in sustainable development

### Recent activities undertaken by IUCN in India include

- Himalayan Water and Nature Initiative- innovative management practices to support mainstreaming of an ecosystem approach to water management;
- Access to environmental justice by the rural communities; and
- Tiger Reserve Assessment.

Work has also been undertaken to implement two important initiatives:

- The Livelihoods and Landscapes Strategy (LLS) is a global initiative that examines the rights and access of the rural poor to forest products in the context of the entire landscape in which people and forests interact; and
- Mangroves for the Future Initiative (MFF), which seeks to address long-term threats to coastal ecosystems, and promote investment in conserving coastal ecosystems as development 'infrastructure'



### Central Zoo Authority

Zoos in India are regulated as per the provisions of the Wild Life (Protection) Act, 1972 and are guided by the National Zoo Policy, 1998. The Central Zoo Authority was established by the Government of India in the year 1992 through an amendment in the Wild Life (Protection) (1991 amendment) Act, 1972. The main objective was to enforce minimum standards and norms for upkeep

and health care of animals in India zoos and restrain mushrooming of unplanned and ill-conceived zoos that were cropping up in the country as adjuncts to public parks, industrial complexes and way sides.

The Central Zoo Authority is a twelve member body headed by a Chairman. Minister of State for Environment & Forests (Forests & Wildlife), Government of India is presently ex-officio Chairman of the Authority. Member Secretary, Central Zoo Authority is the Chief Executive Officer of the Authority. There are 9 regular and 6 contractual staff to assist the Member Secretary in discharge of his duties

To carry out the different functions of the Authority, two committees namely the Administrative Committee (headed by the DGF & SS-to decide on administrative and budgetary issues) and Technical Committee (headed by the Addl. DGF(WL)-to take decisions on technical matters) have been constituted in the Authority. An expert group on zoo designing has also been formed in the Authority to give recommendations on zoo master plans and approval of the enclosure designs submitted by different zoos.

### Activities undertaken during the year

- Recognition of Zoo Rules 2009 were finalized and notified vide Notification No. 643 dated 11.11.2009 in supersession of the Recognition of Zoo Rules 1992.
- Five large, five small and thirty mini zoos and Rescue Centres have been evaluated as zoos during the year.
- Five large, two small and twenty three mini zoos Rescue Centres have been given conditional recognition.

- The Central Zoo Authority is coordinating planned conservation breeding programme for endangered species in Indian zoos. So far, seventy species has been identified under the planned conservation-breeding programme.
- Nineteen exchange proposals of animals between Indian zoos and two exchange proposals between Indian and foreign zoos were approved by the Authority during the period of the Report.
- The Central Zoo Authority has assigned responsibility of preparing and maintaining the studbooks for 14 endangered species to Wildlife Institute of India. Studbooks prepared by WII on Clouded leopard, Snow leopard, Tibetan wolf, Hoolock gibbon and Red panda have been uploaded on the website of the Central Zoo Authority for the purpose of wider use.
- The Central Zoo Authority has provided funds to various zoos to organize workshops and training programmes for zoo personnels.
- The Central Zoo Authority has provided Rs.38.72 lakh to Wildlife Institute of India Dehradun for research project entitled "Studies on housing and enclosure enrichment of some species in selected Indian zoos". An amount of Rs. 425.00 lakh has also been provided to seven Rescue Centres created for rehabilitation of animals rescued from circuses (upto December 2009).
- An amount of Rs. 729.80 lakhs has been released to different zoos and related organization for creation of better animals

housings, veterinary facilities, infrastructure development, research and training purposes during the year 2009-10 (upto December 2009)

### **Wildlife Institute of India, Dehradun**

Wildlife Institute of India (WII) was established in 1982, a premier training and research institution in the field of wildlife and protected area management in South Asia, is an autonomous institute of the Ministry of Environment & Forests, with a 49 member WII Society as the apex body. The Society is chaired by the Union Minister for Environment & Forests, Government of India. The Institute's wide array of capacity building programmes provide a practical and realistic direction to the concept and practice of wildlife conservation.

The Institute conducted various research projects, academic and training programmes during the year. The details of research and education programmes are given in Chapter-7 and 8 respectively.

### **National Tiger Conservation Authority (NTCA)**

#### **Brief Introduction and Objectives**

The Centrally Sponsored Scheme "Project Tiger" was launched in April, 1973 with the objective "to ensure maintenance of a viable population of Tigers in India for scientific, economic, aesthetic, cultural and ecological values, and to preserve for all times, areas of biological importance as a national heritage for the benefit, education and enjoyment of the people."

Progress achievement made during the year  
Legal Steps

- Amendment of the Wild Life (Protection) Act, 1972 for providing enabling provisions for constitution of the National Tiger Conservation Authority and the Tiger and Other Endangered Species Crime Control Bureau. The punishment in case of offence within a tiger reserve has been enhanced. The Act also provides for forfeiture of any equipment, vehicle or weapon that has been used for committing any wild life offence.

Administrative steps

- Strengthening of anti-poaching activities, including special strategy for monsoon patrolling, by providing funding support to Tiger Reserve States, as proposed by them, for deployment of anti-poaching squads involving ex-army personnel/home guards, apart from workforce comprising of local people, in addition to strengthening of communication/wireless facilities.
- One hundred percent Central Assistance provided to thirty eight Tiger Reserves as an additionality for deployment of Tiger protection Force, comprising of ex-army personnel and local workforce.
- Constitution of the National Tiger Conservation Authority with effect from 4.09.2006, for strengthening tiger conservation by, inter alia, ensuring normative standards in tiger reserve management, preparation of reserve specific tiger conservation plan, laying down annual/ audit report before Parliament, constituting State level Steering Committees under the Chairmanship of

Chief Minister and establishment of Tiger Conservation Foundation.

- Constitution of a multidisciplinary Tiger and Other Endangered Species Crime Control Bureau (Wildlife Crime Control Bureau) with effect from 6.6.2007 comprising of officers from Police, Forest, Customs and other enforcement agencies to effectively control illegal trade in wildlife.
- Approval accorded for declaring eight new Tiger Reserves. Notification for Sahayadri Tiger Reserve in Maharashtra has been issued in January, 2010.
- The revised Project Tiger guidelines have been issued to States for strengthening tiger conservation, which apart from ongoing activities, inter alia, include funding support to States for enhanced village relocation/ rehabilitation package for people living in core or critical tiger habitats (from Rs.1 lakh/ family to Rs.10 lakhs/ family, rehabilitation/ resettlement of communities involved in traditional hunting and mainstreaming livelihood and wildlife concerns in forests outside tiger reserves and fostering corridor conservation through restorative strategy to arrest habitat fragmentation.
- A scientific methodology for estimating tiger (including copredators, prey animals and assessment of habitat status) has been evolved and mainstreamed. The findings of this estimation/assessment are bench marks for future tiger conservation strategy.
- An area of 29284.76 sq. km. has been notified by fifteen Tiger States (out of seventeen) as core or critical tiger habitat under section 38 V of the Wildlife

(Protection) Act, 1972, as amended in 2006 (Andhra Pradesh, Arunachal Pradesh, Assam, Chhattisgarh, Jharkhand, Karnataka, Kerala, Madhya Pradesh, Maharashtra, Mizoram, Orissa, Rajasthan, Tamil Nadu, Uttarakhand, and West Bengal.) Two tiger States (Bihar and Uttar Pradesh) have taken a decision for notifying the core or critical tiger habitats (2765.04

sq.km.). The State of Madhya Pradesh has not identified/notified the core/ critical tiger habitat in its newly constituted tiger reserve (Sanjay National Park and Sanjay Dubri Wildlife Sanctuary).

- Memorandum of Understanding developed for better/concerted implementation of conservation inputs through tiger reserve States.

#### Financial Steps

- Financial and technical help is provided to the States under various Centrally Sponsored Schemes, viz. Project Tiger and Development of National Parks and Sanctuaries for enhancing the capacity and infrastructure of the States for providing effective protection to wild animals.

#### International Cooperation

- India has a Memorandum of Understanding with Nepal on controlling trans-boundary illegal trade in wildlife and conservation,



Fig-22. *Panthera tigris* in its natural habitat

apart from a protocol on tiger conservation with China.

- A Global Tiger Forum of Tiger Range Countries has been created for addressing international issues related to tiger conservation.
- During the 14th meeting of the Conference of Parties to CITES, which was held from 3rd to 15th June, 2007 at The Hague, India introduced a resolution along with China, Nepal and the Russian Federation, with directions to Parties with operations breeding tigers on a commercial scale, for restricting such captive populations to a level supportive only to conserving wild tigers. The resolution was adopted as a decision with minor amendments. Further, India made an intervention appealing to China to phase out tiger farming, and eliminate stockpiles of Asian big cat's body parts and derivatives. The importance of continuing the ban on trade of body parts of tigers was emphasized.

- Based on India's strong intervention during the 58<sup>th</sup> meeting of the Standing Committee of the CITES at Geneva from 6<sup>th</sup> to 10<sup>th</sup> July, 2009. the CITES Secretariat has issued a notification to Parties to submit reports relating to compliance of Decisions 14.69 and 14.65 within 90 days with effect from 20.10.2009 (Progress made on restricting captive breeding operations of tigers etc.)

### Reintroduction of Tigers

- As a part of active management to rebuild Sariska and Panna Tiger Reserves where



Fig-23. Tiger relocation

tigers have become locally extinct, reintroduction of tigers/tigresses have been done.

- Special advisories issued for in-situ build up of prey base and tiger population through active management in tiger reserves having low population status of tiger and its prey.

### Creation of Special tiger Protection Force (STPF)

- The policy initiatives announced by the Finance Minister in his Budget Speech of 29.2.2008, interalia, contains action points relating to tiger protection. Based on the one time grant of Rs. 50.00 crore provided to the National Tiger Conservation Authority (NTCA) for raising, arming and deploying a Special Tiger Protection Force, the proposal for the said force has been approved by the competent authority for 13 tiger reserves. Rs. 93 lakhs each has been released to Corbett, Ranthambhore & Dudhwa Tiger Reserve for creation of STPF in remaining 10 Tiger Reserves in 2009-10. Since then, the guidelines of the STF have been revised for deploying forest personnel in place of Police, with scope for involving local people like the Van Gujjars.

- In collaboration with TRAFFIC-INDIA, action has been taken for an online wildlife crime database, and Generic Guidelines for preparation of reserve specific Security Plan has

been evolved.

### Progress / Achievements made during the year

- Funding support to thirty eight tiger reserve in seventeen States.
- EFC of Project Tiger Scheme revised to include additionalities for implementing the Tiger Task Force recommendations and



enhancing the village relocation/ rehabilitation package for people living in core areas of tiger reserves.

- As per the findings of the recent all India estimation on tiger using the refined methodology, the total country-level population of tiger is 1411 (mid value); the lower and upper limits being 1165 and 1657 respectively. The new findings, which are based on statistical methods and not comparable with the earlier estimates based on pugmark counts, indicate a poor status of tiger population outside tiger reserve and protected areas in the seventeen tiger States. The tiger population, by and large, in the tiger reserves and protected areas of such States are viable, while requiring ongoing conservation efforts. As informed by the State, the population of lion is  $359 \pm 10$ , which has increased over the years. As a part of the recent all India tiger estimation, only the spatial occupancy of leopard within the seventeen tiger States has been ascertained.
- An area of 29284.76 sq. km has been notified by fifteen Tiger States (out of seventeen) as core or critical tiger habitat under section 38V of the Wildlife (Protection) Act, 1972, as amended in 2006 (Andhra Pradesh, Arunachal Pradesh, Assam Chhattisgarh, Jharkhand, Karnataka, Kerala, Madhya Pradesh, Maharashtra, Mizoram, Orissa, Rajasthan, Tamil Nadu, Uttarakhand, and West Bengal). Two tiger States (Bihar and Uttar Pradesh) have taken a decision for notifying the core or critical tiger habitats (2765.04 sq. km.). The State of Madhya Pradesh has not identified / notified the core/ critical

tiger habitat in its newly constituted tiger reserve (Sanjay National Park and Sanjay Wildlife Sanctuary)

#### Recent initiatives

- Implementing a tripartite MOU with tiger States, linked to fund flows for effective implementation of tiger conservation initiatives.
- Revised the Special Tiger Protection Force (STPF) guidelines to involve local people like Van Gujjars and others in field protection
- Rapid assessment of tiger reserves done twelve good, nine satisfactory and sixteen poor.
- Special crack teams sent to tiger reserves affected by left wing extremism and low population status of tiger and its prey.
- All India meeting of Field Directors convened on 25 and 26 July, 2009 under the Chairmanship of the Minister of State (Independent Charge) for Environment and Forests for reviewing the status of field protection and related issues in tiger reserves.
- Chief Ministers of tiger States addressed at the level of the Minister of State (Independent Charge) for Environment and Forests on urgent issues, viz. implementation of the tripartite MOU, creation of the Tiger Conservation Foundation, stepping up protection etc.
- Chief Ministers of States having tiger reserves affected by left wing extremism and low population status of tiger and its prey addressed for taking special initiatives.

- Field visits to Bhadra, Corbett, Sariska and Ranthambhore made by the Minister of State (Independent Charge) for Environment and Forests to review the initiatives and problems relating to tiger conservation.
- Steps taken for modernizing the infrastructure and field protection.
- Advisory issued for involvement of Non-Governmental Experts in the forthcoming all India tiger estimation.
- Core Committee involving outside experts constituted for overseeing the forthcoming all India tiger estimation.
- Report of the Special Investigation Team (STI) constituted for looking into the local extension of tiger in the Panna Tiger Reserve sent to the State (Madhya Pradesh) for the needful action.
- Issue of tiger farming and trafficking of tiger body parts discussed at the level of Minister of State (Independent Charge) for Environment and Forests with the Chinese Authorities.
- Action taken for amending the Wildlife (Protection) Act to ensure effective conservation.
- Initiatives taken for improving the field delivery through capacity building of field officials, apart from providing incentives.
- Decision taken to host the World Tiger Summit in October-November, 2010.

### Regulatory Acts/Rules governing the program and promulgation of new Acts, if any, along with the details

The Wildlife (Protection) Act, 1972, is the main regulatory Act governing the program. The said Act has been amended

in 2006 to provide a separate Chapter (IVB) for strengthening tiger conservation.

### Budget allocation of the scheme during the year and progress of expenditure

Details are given in Table- 9, Table-10 and Table-11.

### Implementing organization along with details

The Project is implemented in the designated tiger reserves through respective State Governments, as a Centrally Sponsored Scheme.

## Project Elephant

### Introduction and Objectives

Project Elephant (PE) was launched by the Government of India in the year 1991-92 as a Centrally Sponsored Scheme with following objectives:

- To protect elephants, their habitat & corridors
- To address issues of man- animal conflict
- Welfare of domesticated elephants

Financial and technical support is being provided to major elephant bearing States in the country. The Project is being mainly implemented in 13 States / UTs, viz. Andhra Pradesh , Arunachal Pradesh, Assam, Jharkhand, Karnataka, Kerala, Meghalaya, Nagaland, Orissa, Tamil Nadu, Uttarakhand, Uttar Pradesh and West Bengal. Small support is also being given to Tripura, Maharashtra and Chhattisgarh.

Outlay /Expenditure during Five Year Plans (in Rs. crores) is given in Table-12.

Table-9. State wise release for Centrally Sponsored Scheme of Project Tiger, during 2009-10 (as on 03.03.2010)

(Rs. in lakhs)

Sl. No.	Tiger Reserve	Total Amount Released
1.	Andhra Pradesh	94.9100
2.	Arunachal Pradesh	48.8600
3.	Assam	184.7700
4.	Bihar	8.0000
5.	Chhattisgarh	1,338.7000
6.	Jharkhand	110.7350
7.	Karnataka	644.9720
8.	Kerala	281.1600
9.	Madhya Pradesh	2,419.4460
10.	Maharashtra	362.8770
11.	Mizoram	2,171.0000
12.	Orissa	170.0800
13.	Rajasthan	10,694.1700
14.	Tamil Nadu	240.5500
15.	Uttarakhand	241.7050
16.	Uttar Pradesh	414.4370
17.	West Bengal	298.5500
	<b>Total</b>	<b>19,724.9260</b>

#### Important Initiatives taken during the year

- A Task Force on Project Elephant under the Chairmanship of Dr. Mahesh Rangarajan, Professor, Department of History, University of Delhi constituted on Project Elephant to provide detailed recommendations to upgrade the project to bring about more effective conservation and management regime for the species in India.
- Consultation held with affected states and Ministry of Railways in September 2009 to minimize death of elephants in train accidents. Needful initiatives have been taken by the Railway Board.
- Consultation held with all Elephant Range states in November 2009 to mitigate elephant – human conflict. States advised to take several short term and long term actions including preparation of Action Plan.
- A two day workshop sponsored to Wildlife Trust of India ( WTI ) on securing elephant corridors in Uttarakhand and Uttar Pradesh, held at Dehradun in July 2009 which was attended by more than sixty participants

## Ministry of Environment & Forests

**Table-10.** Reserve-wise release for Centrally Sponsored Scheme of Project Tiger, during 2009-10 (as on 03.03.2010)

(Rs.in lakhs)

Sl.No.	Tiger Reserve	State	Total Amount Released
1.	Nagarjunsagar	Andhra Pradesh	94.9100
2.	Namdhapa	Arunachal Pradesh	-
3.	Pakke	Arunachal Pradesh	48.8600
4.	Kaziranga	Assam	165.0000
5.	Manas	Assam	-
6.	Nameri	Assam	19.7700
7.	Valmiki	Bihar	8.0000
8.	Achanakmar	Chhattisgarh	1,193.5000
9.	Indravati	Chhattisgarh	42.1500
10.	Udanti-Sitanadi	Chhattisgarh	103.0500
11.	Palamau	Jharkhand	110.7350
12.	Bandipur	Karnataka	161.6970
13.	Bhadra	Karnataka	128.0870
14.	Dandeli Anshi	Karnataka	144.3700
15.	Nagarhole	Karnataka	210.8180
16.	Periyar	Kerala	151.8000
17.	Bandhavgarh	Madhya Pradesh	159.9600
18.	Kanha	Madhya Pradesh	277.0600
19.	Panna	Madhya Pradesh	175.8950
20.	Pench	Madhya Pradesh	158.3200
21.	Sanjay Dubri	Madhya Pradesh	145.8400
22.	Satpura	Madhya Pradesh	1,502.3710
23.	Melghat	Maharashtra	155.1850
24.	Pench	Maharashtra	75.8720
25.	Tadoba-Andheri	Maharashtra	131.8200
26.	Dampa	Mizoram	2,171.0000
27.	Satkosia	Orissa	127.7300
28.	Similipal	Orissa	42.3500
29.	Ranthambhore	Rajasthan	10,560.0000
30.	Sariska	Rajasthan	134.1700
31.	KMTR	Tamil Nadu	138.4550
32.	Mudumalai	Tamil Nadu	51.8540
33.	Corbett Tiger	Uttarakhand	241.7050
34.	Buxa	West Bengal	38.5800
35.	Sunderbans	West Bengal	259.9700
36.	I) Dudhwa	Uttar Pradesh	285.9570
	II) Katerniaghat	Uttar Pradesh	128.4800
37.	Anamalai	Tamil Nadu	50.2450
38.	Parambi Kulam	Kerala	129.3600
		<b>Total</b>	<b>19724.93</b>

Table-11. Plan Expenditure for Project Tiger Scheme during 2009-10

(Rs. in crores)

S. No.	Budget Head	BE 2009-10	RE 2009-10	Total expenditure	Percentage expenditure w.r.t. RE
	<b>Project Tiger Scheme</b>				
1.	3601 (assistance to States excluding North Eastern Region)	183.65	173.83	173.20	100%
2.	2552 (assistance to North Eastern Region)	55.30	24.30	24.05	99%
3.	2406 (National Tiger Conservation Authority)	1.18	6.00	0.80	13.35%
	<b>Total</b>	<b>240.13</b>	<b>204.13</b>	<b>198.05</b>	<b>97.02%</b>
	<b>Biodiversity Conservation and Rural Livelihood Improvement Project</b>				
1.	2406 BCRLIP 02.110.01.07.	1.00	0.40	0.131	32.75%
2.	3601 BCRLIP (EAP)	2.00	-	Nil	Nil
	<b>Total</b>	<b>3.00</b>	<b>0.40</b>	<b>0.131</b>	<b>32.75%</b>

including State, Railways and other officials, scientists and NGO's. The workshop came out with important resolutions.

- In order to enhance the capacity of Vets on elephant health care, a two week Training of Trainees (TOT) sponsored to College of Veterinary Sciences, Assam

Agriculture University, Guwahati, which held in December 2009 at Guwahati and was attended by about nineteen Vets from across the country.

- One more workshop has been sponsored to Wildlife Trust of India (WTI) on securing elephant corridors of South India to be

Table-12. Outlay /Expenditure during Five Year Plans

(in Rs. crores)

	Outlay	Allotment	Expenditure
8 <sup>TH</sup> PLAN(92-97)	23 .00	20.75	19.51
9 <sup>TH</sup> PLAN(97-02)	35.00	24.60	30.48
10 <sup>TH</sup> PLAN (02-07)	71.00	67.25	63.83
11 <sup>th</sup> Plan	81.99		
2007-08	17.00	17.00	16.76
2008-09	20.00	21.50	21.47
2009-10	21.50	21.50	11.57 (upto Nov 09)

organized in Tamil Nadu in current Financial Year.

### Estimation of Wild Elephants

All India estimation of wild elephant population is done every five years. The trend of last four estimations clearly indicates increase in population of wild elephants in the country. The result of last four estimations are given in Table-13.

### Elephant Reserves

With the notification of Uttar Pradesh Elephant reserve in the year 2009, the total number of Elephant Reserves (ERs) in the country has become twenty seven where as

permission for five more Elephant Reserves- Baitarini ER & South Orissa ER in Orissa, Lemru & Badakhod in Chattisgarh and Khasi ER in Meghalaya has been accorded by the Ministry. The area under these would be extending over about 69582 sq km. The list of ERs with date of Notification and area is given in Table-14.

### Animal Welfare

#### Introduction and Objectives

The Animal Welfare Division is entrusted with the implementation of the provisions of the Prevention of Cruelty to Animals Act, 1960 (59 of 1960). Plan



Fig-24. Elephant needs proper habitat

Table-13. Estimated population of wild elephants

REGION	STATE	ELEPHANT POPULATION			
		1993	1997	2002	2007
<b>North-East</b>	Arunachal	2102	1800	1607	1690
	Assam	5524	5312	5246	5281
	Meghalaya	2872	1840	1868	1811
	Nagaland	178	158	145	152
	Mizoram	15	22	33	12
	Manipur	50	30	12	Nil
	Tripura	100	70	40	59
	West Bengal (North)	186	250	292	300-350
<b>Total for North-East</b>		<b>11027</b>	<b>9482</b>	<b>9243</b>	<b>9305-9355</b>
<b>East</b>	West Bengal (South)	14	26	36	25
	Jharkhand	550	618	772	624
	Orissa	1750	1800	1841	1862
	Chattisgarh	-	-	-	122
<b>Total for East</b>		<b>2314</b>	<b>2444</b>	<b>2649</b>	<b>2633</b>
<b>North</b>	Uttarakhand ( * part of erstwhile UP )	828*	1130*	1582	1346
	U.P.	47	70	85	380
<b>Total for North</b>		<b>875</b>	<b>1200</b>	<b>1667</b>	<b>1726</b>
<b>South</b>	Tamilnadu	2307	2971	3052	3867
	Karnataka	5500	6088	5838	4035
	Kerala	3500	3600	3850	6068
	Andhra Pradesh	46	57	74	28
	Maharashtra	-	-	-	7
	<b>Total for South</b>		<b>11353</b>	<b>12716</b>	<b>12814</b>
<b>Islands</b>	<b>Andaman &amp; Nicobar</b>	<b>35</b>	<b>35</b>	<b>40</b>	<b>NA</b>
<b>Grand Total</b>		<b>25604</b>	<b>25877</b>	<b>26413</b>	<b>27669</b> - <b>27719</b>

Schemes are in operation for implementation of the statutory obligations under this Act. Two statutory bodies viz. Animal Welfare Board of India (AWBI) and Committee for the Purpose of Supervision and Control of

Experiments on Animals (CPCSEA) have also been set up under this Act.

Activities relating to Animal Welfare are looked after by the Animal Welfare Division of the Ministry of Environment and

## Ministry of Environment & Forests

**Table-14.** Elephant Reserves in India

Sl. No	Elephant Range	Elephant Reserve with date of notification	State	Total Area (Sq. Km)
I	Eastern India (South West Bengal- Jharkhand-Orissa)	1. Mayurbhanj ER(24.10.02)	W. Bengal	414
		2. Singhbhum ER (26.9.01)	Jharkhand	4530
		3. Mayurbhanj ER (29.9.01)	Orissa	3214
		4. Mahanadi ER (20.7.02)	Orissa	1038
		5. Sambalpur ER (27.3.02)	Orissa	427
		6. Baitarni ER#	Orissa	1755
		7. South Orissa ER#	Orissa	4216
		8. Lemru #	Chattisgarh	450
		9.Badalkhol-Tamorpingla- #	Chattisgarh	1048.30
	<b>Total</b>			<b>17092.30</b>
II	North Brahmaputra (Arunachal – Assam)	10. Kameng ER (19.6.02)	Arunachal	1892
		11. Sonitpur ER (6.3.03)	Assam	1420
		<b>Total</b>		<b>3312</b>
III	South Brahmaputra (Assam- Arunachal)	12. Dihing-Patkai ER (17.4.03)	Assam	937
		13. South Arunachal ER ( 29-2-08 )	Arunachal	1957.50
		<b>Total</b>		<b>2894.50</b>
IV	Kaziranga (Assam- Nagaland)	14. Kaziranga – Karbi Anglong ER (17.4.03)	Assam	3270
		15. Dhansiri-Lungding ER (19.4.03)	Assam	2740
		16. Intanki ER (28.2.05)	Nagaland	202
		<b>Total</b>		<b>6212</b>
V	Eastern Dooars (Assam- W. Bengal)	17. Chirang-Ripu ER (7.3.03)	Assam	2600
		18. Eastern Dooars ER (28.8.02)	W. Bengal	978
		<b>Total</b>		<b>3578</b>
VI	E. Himalayas (Meghalaya)	19 Garo Hills ER (31.10.01)	Meghalaya	3,500
		20. Khasi Hills ER#	Meghalaya	1331
		<b>Total</b>		<b>4831</b>
VII	Nilgiri –Eastern Ghat (Karnataka- Kerala- Tamilnadu-Andhra)	21. Mysore ER (25.11.02)	Karnataka,	6724
		22. Wayanad ER (2.4.02)	Kerala	1200
		23. Nilgiri ER (19.9.03)	Tamilnadu	4663
		24. Rayala ER (9.12.03)	Andhra	766
		<b>Total</b>		<b>13353</b>
VIII	South Nilgiri (Kerala- Tamilnadu)	25. Nilambur ER (2.4.02)	Kerala	1419
		26. Coimbatore ER (19.9.03)	Tamilnadu	566
		<b>Total</b>		<b>1985</b>
IX	Western Ghat (Tamilnadu- Kerala)	27. Anamalai ER (19.9.03)	Tamilnadu	1457
		28. Anamudi ER (2.4.02)	Kerala	3728
		<b>Total</b>		<b>5185</b>
X	Periyar (Kerala- Tamilnadu)	29. Periyar (2.4.02)	Kerala	3742
		30. Srivilliputtur ER(19.9.03)	Tamilnadu	1249
		<b>Total</b>		<b>4991</b>
XI	Northern India (Uttaranchal-U.P.)	31. Shivalik ER (28.10.02)	Uttaranchal	5405
		32. Uttar Pradesh ER ( 9.9.09)	U.P.	744
		<b>Total</b>		<b>6149</b>
<b>TOTAL</b>				<b>69582.80</b>

# Approved by Govt. of India, but not yet notified by the State Government.



Forests with the mandate to prevent the infliction of unnecessary pain or suffering on animals. To accomplish this mission a three-pronged approach has been adopted as follows:-

### Regulatory

The main task of the division is to implement the various provisions of Prevention of Cruelty to Animals Act, 1960. Under this Act, a number of Rules have also been framed for various purposes.

Some of the important Rules framed are:

- Performing Animals (Registration) Rules, 2001 as amended.
- Transport of Animals Rules, 1978, 2001 & 2009.
- Prevention of Cruelty (Slaughter Houses) Rules, 2001.
- Prevention of cruelty to Animals (Establishment and Regulation of Society for Prevention of Cruelty to Animals) Rules 2001.
- Animal Birth Control (Dogs) Rules, 2001.
- Breeding of and Experiments on Animals (Control and Supervision) Rules, 1998 as amended.

### Developmental

The Division provides financial assistance through the Animal Welfare Board of India, for construction of Shelter House, Dispensaries etc. for stray, infirm and abandoned animals. It also gives grants for ambulance and vehicles in connection with treatment and transportation of sick, injured and rescued animals. Another major

developmental programme is immunization and sterilization of stray dogs.

### Educational

Workshops, seminars and Conferences are organized from time to time. Newsletters of AWBI also help in dissemination of information. Information is also provided through the website of the Ministry.

### Corresponding Outcomes

The following schemes are being implemented by Animal Welfare Board of India:-

- Scheme for provision of Ambulance Services to Animals in Distress
- Scheme for Animal Birth Control and Immunization of stray dogs
- Scheme for Relief to Animals during Natural Calamities and unforeseen Circumstances
- Scheme for Provision of Shelter houses for animals
- Animal Welfare Board of India Plan Scheme  
Animal Welfare Division handles following two schemes:
- Committee for Purpose of Control and Supervision of Experiments on Animals (CPCSEA)
- National Institute of Animal Welfare (NIAW)

### Description of Schemes Implemented by the AWBI

#### Scheme for provision of Ambulance Services to Animals in Distress

Under this Scheme, Ambulance/ Rescue Vehicles are provided to the NGOs/ AWOs/ Gaushalas working in the field of

animal welfare. The ambulance services are to be used for the following purposes:

- to ensure that immediate treatment / first aid is given to sick, injured stray / abandoned animals;
- to act as an outreach to help the poor people whose animals are involved in accidents or affected with disease and are immobile;
- to act as mobile clinic to hold camps where animals in a village can be vaccinated and treated;
- to pick up unwanted or hostile animals from human habitations;
- to implement the ABC/AR programme by collecting dogs and then releasing them after sterilization and immunization;

Under this scheme the NGOs/AWOs/ Gaushalas are assisted to the extent of 90% project cost for purchase of a suitable vehicle and equipment, modifications and fittings thereon. The maximum amount of grant-in-aid is limited to Rs. 3.50 lakhs for purchase of the vehicle and Rs. 1.00 lakhs for equipment, modification and fittings thereon.

### Scheme for Animal Birth Control and Immunization of stray dogs



Keeping in view the overpopulation of stray dogs throughout the country and also the increase of human / animal deaths due to Rabies, this scheme was being implemented by the Ministry of Environment & Forests but now it has been transferred to the Board to facilitate sterilization and immunization of stray dogs through the NGOs including SPCAs throughout the country. The Local Governments/Municipal bodies are also

showing increased keenness to become stakeholders in the programme. After this scheme has been transferred to the Board, the local bodies are also applying to the Board for financial assistance. There is a urgent need to expand this scheme to cover more Metros & rural areas to address the issue effectively.

Under the scheme, the norms for financial assistance are at Rs. 370/- per dog for pre & post operative care including medicines & ARV and Rs. 75/- per dog for catching and relocation of dog (Total Rs. 445/- per dog). AWBI has proposed "Rabies free India" programme to be taken up for next 10 years. At Present, Ministry has taken up the matter with the Planning commission to enhance the allocation under existing ABCScheme.

### Scheme for Relief to Animals during Natural Calamities and Unforeseen Circumstances

We face natural calamities every year in the form of floods, cyclones, droughts and earthquakes. In such circumstances there is an immediate requirement for the provision of relief to affected animals by providing fodder, adequate shelter, medical attention otherwise the animals would perish. In the recent past, there was severe drought in the states of U.P., Bihar, Madhya Pradesh, Jharkhand and floods in the States of Karnataka, Andhra Pradesh and North eastern states.

Also large number of animals are illegally transported and slaughtered in violation of the Prevention of Cruelty to Animals Act, 1960 and Rules and Regulations in force. Emergency services have to be provided to such rescued animals and also

animals rescued from various organizations, circuses etc. The above scheme provides for this.

It is proposed to extend financial assistance to AWOs, State Governments/UTs, local bodies working in the affected areas for providing relief to the animals affected during natural calamities and for relief of animals rescued from illegal transportation, slaughter, circuses etc.

### Scheme for Provision of Shelter Houses for animals

There are a large number of animals in our country without proper shelter specially in Goshalas. A number of them are not cared for and are left in the streets, either wounded or suffering from various diseases. Though there are shelter houses operating at various places, their number is not adequate and the facilities provided are insufficient. This scheme endeavours to fill this gap and provide requisite services for the care and protection of uncared animals by making provision for establishment and maintenance of shelter houses to various NGOs, AWOs, Goshalas etc.

Under this Scheme, the AWOs are assisted to the extent of 90% of the project cost of the construction of a shelter house with a ceiling of Rs. 25 lakhs including 10% contribution to be made by the AWOs. The amount is released in two equal installments.

### AWBI Plan

The Plan account proposals relate to provision of assistance for the following type of activities:

- Financial assistance to Animal Welfare

Organisations for holding animals in distress and their treatment.

- Humane Education Programmes implemented directly by the Board as well as support to AWOs for this purpose.
- Capital expenditure at the Board's Headquarters i.e. expenditure on non-recurring items such as purchase of Assets/equipments.
- Expenditure on a variety of other animal welfare activities such as Rescue of Cattle from illegal smuggling and transportation, rehabilitation of rescued circus animals. Lab Animals, inspections. Legal expenses in connection with court cases pertaining to animal welfare. A large proportion of the Plan funds are allocated to the nearly 2700 NGOs / Goshalas/ SPCAs & AWOs that have been recognized by the Board. Such funding is made available subject to the NGOs fulfilling the requisite conditions for seeking grants.

### Schemes handled by Animal Welfare Division Committee for Purpose of Control & Supervision of Experiments on Animals (CPCSEA)

The main objective of the Prevention of Cruelty to Animals Act (PCA), 1960 is to prevent infliction of unnecessary pain or suffering on animals. Accordingly, the Committee for Purpose of Control and Supervision of Experiments on Animals (CPCSEA) has been constituted under provisions of Section 15 of this Act. The Act provides for the duties and powers of the CPCSEA. and also penalties, in event of contravention of orders made, or conditions

imposed by the Committee. The mandate of the Committee is to ensure that while conducting various types of experiments, in connection with medical research or education, animals are not subjected to avoidable pain or suffering. The CPCSEA functions within the ambit of the PCA Act, and Rules frame under it e.g. Rules for Breeding of and Experiments on Animals (Control and Supervision), 1998 as amended.

CPCSEA has been reconstituted on 19.10.2006 as a committee of experts from several areas, including medicine, veterinary science, pharmaceuticals, biotechnology, biostatistics, animal behavior and ethics. A total of 1313 institutions have been registered by CPCSEA and 492 CPCSEA nominees have been appointed to assist the Committee in its functions. During this financial year, five CPCSEA meeting has been conducted wherein more than one hundred ninety two project proposals on large animals have been considered and one hundred twenty one have been approved and six large animal house facilities have been approved. One National Conference of CPCSEA was conducted in Dr. MCRHRD Institute of Andhra Pradesh in the month of January and financial aid was given to ADRI, Lucknow to conduct Conference on Animal Ethics. National conference of CPCSEA was held in Delhi on 15<sup>th</sup> January, 2010 also.

### National Institute of Animal Welfare (NIAW)

The National Institute of Animal Welfare (NIAW) has been set up as a subordinate office of the Ministry of Environment and Forests. The objective of NIAW is to impart training and education in

Animal Welfare on a diversified basis comprising, among other things, animal management, their behaviour and ethics. The aim is to create an enabling environment for fulfillment of the statutory requirements as laid down in the Prevention of Cruelty to Animals Act, 1960.

NIAW has been conceptualized as an apex body in the field of animal welfare and its broad mandate covers the need to improve animal welfare through education, research and public outreach. The Institute has been operational since January, 2006 and the process of appointment of faculty is underway.. The Institute is expected to evolve as a premier body with international stature, with participation of faculty / trainees from other countries.

The work of designing and running in service and other short term training courses was assigned to Ed. CIL, a public sector enterprise under the Ministry of Human Resource Development, on turnkey basis. The courses have commenced from 2.1.2006 and in-service courses of duration of one/two/four weeks are underway as per schedule. The institute has successfully completed more than eighty training programme for different stakeholders (NGO personnel, Veterinary Doctors, Students, Animal handlers etc) till date. The training work is presently undertaken with the help of experts/guest faculty by the Animal Welfare Division itself. The other major initiative taken for practical training , capacity building and Clinical skill up gradation of Veterinary Doctors and Para Veterinary staff through Project Vet-train under collaboration with renowned NGO namely Vet Beyond Border, Australia . Pilot phase of "Project Vet

train” has successfully completed in which 6 training programme has completed. Hon’ble Minister has already approved in principle for implementation of the Phase 2 of this project.

As per the Guidelines of VCI, the internship training programme for 2009-10 will commence from Jan to July 2010, for different Universities (G.B.Pant, Mathura, Andhra Pradesh’s Rajendra Nagar, Tirupati and Gannavaram). Also four hundred students will be provided “Internship training” before their award of B.Vsc Degree. Now the tender process of training work has assigned to M/s AITD, who will start their work from Feb, 2010.

A Steering Committee has been set up under the Chairmanship of Secretary (E&F) to review the modalities of operation of NIAW and to facilitate constant review of the functioning of the Institute. Apart from officials of the Ministry, the Steering Committee comprises of DG (CSIR) or his representative. Member Secretary (CZA), Animal Husbandry Commissioner. Ministry of Agriculture and a representative of the Ministry of Information and Broadcasting. The last meetings of the Steering Committee has been held in June, 2008.

### Policy issues and possible options

The Ministry proposes to lay emphasis on animal welfare activities during the 11th Plan period inter-alia in terms of:

- Greater sensitization of all categories of agencies / institutions regarding the need for compliance with animal welfare laws.
- Dissemination of information through

Ministry’s website ([www.envfor.nic.in](http://www.envfor.nic.in)) and under the Right to Information Act, 2005.

- Streamlining of procedures to facilitate compliance with extant laws and procedures and as a measure of good governance.
- Opening up a meaningful dialogue with all affected constituents in a transparent manner to facilitate policy changes wherever required.
- Continuing the efforts to ensure that National Institute of Animal Welfare (NIAW) grows in a stature and evolves into a prestigious body with international presence.
- Recognition of the need to provide a firm institutional basis to statutory bodies such as the CPCSEA.
- Recognition of the need for setting out improved evaluation parameters to assess the performance of ongoing Animal Welfare Schemes.
- Improvement in management of Animal Welfare Schemes as a part of the E-Governance initiative of the Ministry of Environment & Forests.
- Focus on enhancing public awareness of animal welfare issues through greater role of media and audio visual aids, as also organizing direct outreach programmes, workshops and seminars.
- Greater participation in various international forum to ensure a prominent role for India in shaping the international policy perspective on animal welfare issues.

### Programme issues and possible options

The thrust areas that require focus during the year 2009-2010 are described below:

Rabies is one of the most dreadful infectious diseases affecting both human beings and animals. Rabies is prevalent throughout India except the islands of Lakshadweep and Andaman & Nicobar but has a low public health priority. Considering that Rabies is fully preventable disease and the huge expenditure incurred on post-exposure vaccination both in humans as well as animals, there is an urgent need to control and finally eradicate this dreaded disease from India as has been achieved by several European countries as well as South East Asian countries like Malaysia and Singapore.



The AWBI is currently the only agency which is involved with controlling the population of stray/community dogs through its Animal Birth Control (ABC) Programme and administering anti-rabies vaccinations (ARV) to them in some metros of the country. At present approximately 1,00,000 dogs are sterilized/immunized which is grossly inadequate, given the population of street dogs about 20 Million. Under the Animal Birth Control scheme, the norms for financial assistance are at Rs. 370/- per dog for pre & post operative care including medicines & ARV and Rs. 75/- per dog for catching and relocation of dog (Total Rs. 445/- per dog). AWBI has requested to enhance the present cost of sterilization of dogs from Rs.445/- to Rs.800/- to adopt latest technique and less time to recover the animal.

WHO has also recommended controlling the population of dogs through ABC/AR programme rather than killing them, which is inhumane and does not go well with our cultural ethos of love & compassion for animals. This policy also supports rules under Prevention of Cruelty to Animals Act. 1960. (ABC Dogs Rules-2001).

An ambitious programme (Rabies free India) of this nature will require appropriate support from the Planning Commission. Projections for supporting this programme have been made in the following manner:

- Central Sector Schemes - Provision of Shelter Houses for Animals. Provision for Ambulance services to Animals in Distress and Animal Birth Control & Immunization of Stray Dogs will support enhanced ABC operations. Thus additional allocations for these three Central Sector Schemes are proposed on these grounds.
- Plan Fund heads - Humane Education and Awareness, Oral Anti Rabies Vaccinations, Capacity Building, Research and Monitoring will support other elements of the Rabies Control Programme as described in the preceding paragraphs. Proposed allocations for these have been modeled on the basis of needs of the Rabies Control Programme as well as ongoing animal welfare activities in the country that are in addition to the Rabies control Programme.

### - Capacity Building Gaushalas & ABC

The country's large population of stray / abandoned cattle is supported by a network of Gaushalas and Pinjrapoles, which are in turn provided several types of support by the AWBI. A number of these Gaushalas

were set up by philanthropists and individuals and groups, which, though committed to the cause of animal welfare did not necessarily have the management and other capacities required for effective functioning. It is therefore desirable that the AWBI should undertake a special drive over the year 2010-11 to modernize Gaushalas and provide requisite training to Gaushala personnel. Similarly the Veterinary Doctors/ Para Veterinary staff/ Animal Handlers are trained to undertake the new technique of Surgery.

### CPCSEA

During the 2009-10, it is proposed to step up the level of activities undertaken by CPCSEA in terms of

- Expansion in the coverage of Institutions, which are registered with CPCSEA;
- Emphasis on inspections of animal house facilities throughout the country;
- Appointment of larger number of nominees, who are on board the Institutional Animals Ethics Committees of various institutions;
- Imparting training to these CPCSEA nominees;
- Increasing the focus on public outreach by way of publications, media coverage and seminars, with special emphasis on the scientific community, which relies on use of animals in experimentation.
- Undertaking the IEC activities (Seminar and other awareness programme)

### National Institute of Animal Welfare (NIAW)

The activities of the Institute are

expected to grow significantly during year 2009-10 in following areas:

- Scope and number of trainings.
- Practical training for capacity building and Clinical up gradation of Veterinary Doctors/ Para Veterinary staff
- Introduction of specialized training in a phased manner with induction of faculty installation of equipment, upgradation of facilities (including provision for new hostels) as also functioning of an animal hospital and first-aid service through Mobile clinic.
- Activities to undertake Information, communication and Education to all the stakeholders.

### Formulation of Standards and Performance Monitoring

There are nearly 2,700 NGOs affiliated to AWBI, out of which nearly 1,000 are provided regular financial support by the Board for a variety of activities. The grants range from a few thousand to several lakhs. A strong need is felt for improved assessment and performance monitoring of these groups on the basis of standards, indicators and criteria that are rooted in scientific and animal welfare good practices. Though the Board does inspect each group upon receiving grant applications, it is proposed to streamline and professionalize this process.

A two stage approach is proposed for this comprising of developing appropriate standards for the functioning of various animal welfare groups. Building on such standards, it is further proposed to develop a professional panel of referees who will be trained in monitoring and evaluation techniques. Finally,

a comprehensive monitoring and evaluation plan (M&E) will be developed that will include details of monitoring schedules, frequencies, methodologies, and analysis. Ministry has formulated a committee to undertake the methods of evaluation related with the schemes undertaken by AWBI.

The evaluation report of the TANUVAS has been accepted by the Ministry. The corrective steps suggested by the evaluators shall be followed by the implementing agency for successful implementation of the project.

**Summary of findings/recommendations of evaluation done for schemes and also the need for restructuring/redesigning the schemes**

The Ministry has appointed an Independent Evaluation Agency to evaluate the following ongoing Animal Welfare Schemes

- Scheme for Provision of Ambulance Services to Animals Distress.
- Scheme for Animal Birth Control & Immunization of Stray Dogs.
- Scheme for Relief to Animals during Natural Calamities and Unforeseen Circumstances.

- Scheme for Provision of Shelter Houses for Animals.

### Purposes

- To assess overall outcome, impact as well as effectiveness.
- To improve the quality of implementation
- To determine continued relevance of the schemes.

A detailed discussion on the finding of Evaluation agency is going on. It will be finalized with the acceptance of all the stakeholders.

National Institute of Animal Welfare (NIAW) is in initial stages of implementation and independent evaluation would be premature at this stage.

CPCSEA is a statutory committee set up under the provision of Section 15 of Prevention of Cruelty to Animal Act, 1960, and functions as a regulatory body. Since the functioning of this committee relates to registration of institute, inspection and approval of animal house facilities and case by case approval of proposal for use of animals in experimentation, independent evaluation is not considered necessary.



**CHAPTER – 3**  
**ENVIRONMENTAL IMPACT**  
**ASSESSMENT**

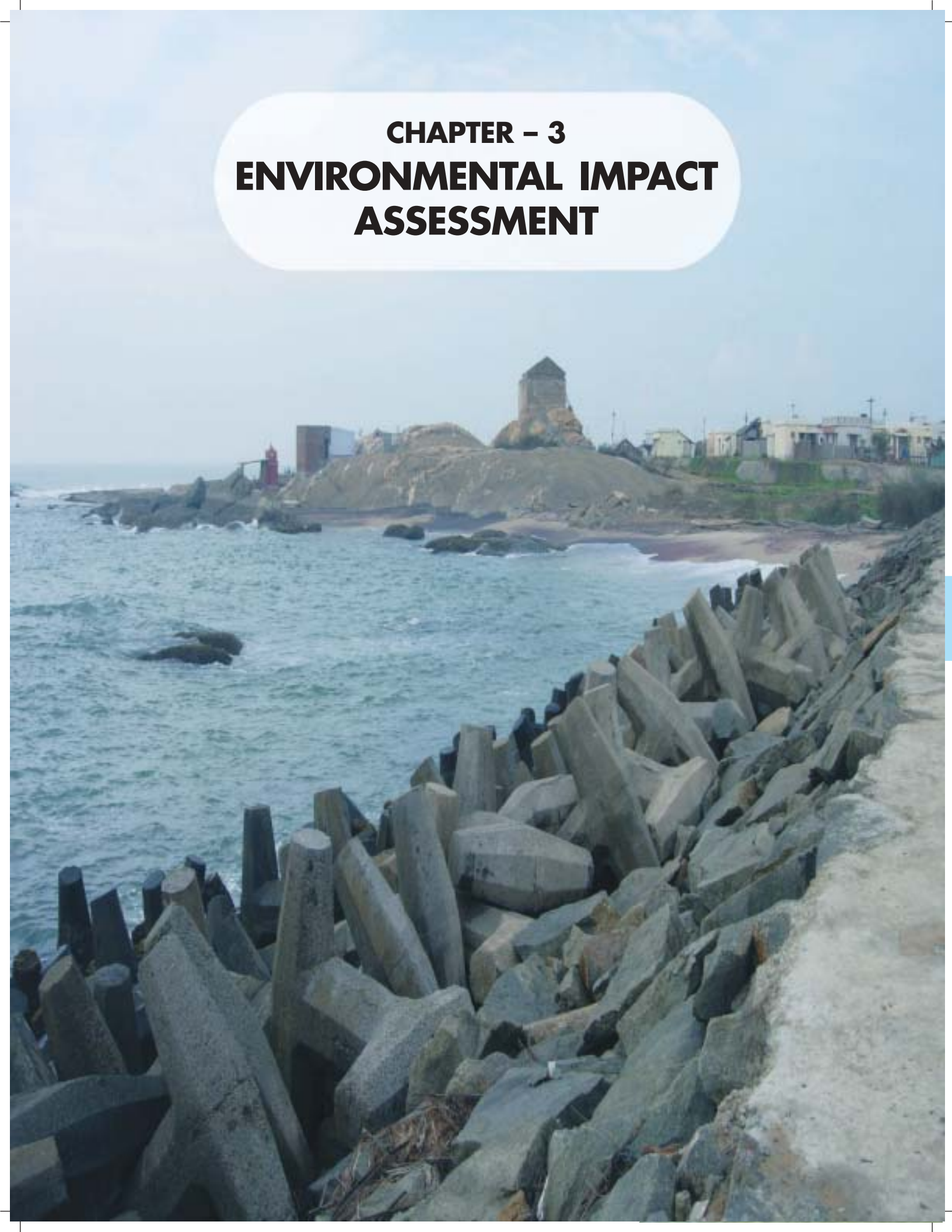

## Environment Impact Assessment (EIA)

### Environment Impact Assessment Notification 2006

The rapid industrial development in the country has increased manifold, the chances of adversely affecting the environment unless timely, adequate, corrective and protective mitigative measures are taken to minimize or neutralize those adverse impacts on environment. The Ministry of Environment and Forests has used Environment Impact Assessment Notification 2006 as a tool to regulate rapid industrial development of the country for minimizing the adverse impact on environment and reversing the trends which may lead to climate change in long run.

In the re-engineered Environment Impact Assessment (EIA) Notification of September 2006, projects were categorized into category 'A' and category 'B' depending on their threshold capacity and likely pollution potential and were appraised for prior environmental clearance at the Central and the State level respectively. Further the notification provided for screening, scoping, public consultation and appraisal. For appraisal of category 'B' projects and activities, State Level Environment Impact Assessment Authorities (SEIAAs) and State Expert Appraisal Committees (SEACs) have been constituted.

### Amended EIA Notification 2009

With a view to further simplify the procedure for obtaining the environmental clearance without compromising or diluting the regulatory framework, the EIA notification has been amended in December, 2009. The amended EIA Notification of December, 2009

provides for exemption of biomass based power plants up to fifteen MW, power plants based on non hazardous municipal solid wastes and power plants based on waste heat recovery boilers without using auxiliary fuel.

### Environmental Clearance to Developmental Projects

As per the provisions of the EIA Notification 2006, several meetings of the Expert Appraisal Committees were convened by the Ministry during the year for appraisal of "A" category projects from sectors of industry, thermal power, infrastructure, river valley, mining and "B" category projects from construction sector where State Environment Impact Assessment Authority has not been constituted. As part of appraisal process the Expert Appraisal Committees also visited project sites for obtaining first hand information about the ground level realities and response of people living in the vicinity. The environmental clearance was accorded to five hundred forty eight projects and Term of Reference (TOR) to six hundred twenty four projects (up to December, 2009). Table-15 gives sectorwise list of environmental clearances and TOR issued to the projects by the Ministry.

### Constitution of State Environment Impact Assessment Authorities (SEIAA)

The Ministry has constituted so far twenty three State/UT level Environment Impact Assessment Authorities (SEIAAs) under sub-section (3) of section 3 of the Environment (Protection) Act, 1986 for appraisal of all 'B' category projects and activities notified in the EIA Notification 2006. During the year SEIAA for Chandigarh UT has been

## Annual Report 2009-2010

**Table-15.** Status of Environment Clearance and TOR issued to Developmental Projects (April 2009- December 2009)

Status of Projects	Sectors													Total	
	Industry		Thermal		River Valley		Mining		Infrastructure & Miscellaneous		Construction and Industrial Estate				
	EC	TOR	EC	TOR	EC	TOR	EC	TOR	EC	TOR	EC	TOR			
<b>Cleared</b>	322	299	30	53	10	39	77	143	57	84	52	6	<b>548</b>	<b>624</b>	
<b>Pending</b>	65	169	30	47	26	-	81	70	53	1	33	1	<b>288</b>	<b>288</b>	
<b>Rejected/ Returned</b>	16				2		40		Nil		2		<b>60</b>		

Note: EC – Environment Clearance, TOR – Terms of Reference

constituted. Table-16 gives complete list of SEIAA's constituted in the States/UTs till date. Consequent upon the constitution of SEIAAs, the Ministry had transferred 'B'

**Table-16.** Constitution of State Level Environment Impact Assessment Authorities (SEIAAs)

S. No.	Name of States / UTs	Date of Notification
1	West Bengal	13.4.2007
2	Meghalaya	23.7.2007
3	Karnataka	11.6.2007
4	Gujarat	12.6.2007
5	Andhra Pradesh	5.7.2007
6	Uttar Pradesh	12.7.2007
7	Daman, Diu & Nagar Haveli *	11.10.2007
8	Himachal Pradesh	11.11.2007
9	Punjab	19.11.2007
10	Puducherry	13.12.2007
11	Madhya Pradesh	8.1.2008
12	Jammu & Kashmir	8.1.2008
13	Chhattisgarh	29.1.2008
14	Tamil Nadu	3.3.2008
15	Arunachal Pradesh	27.3.2008
16	Maharashtra	21.4.2008
17	Haryana	21.4.2008
18	Rajasthan	30.7.2008
19	Delhi	30.7.2008
20	Uttarakhand	22.9.2008
21	Orissa	18.11.2008
22	Sikkim	8.7.2008
23	Chandigarh (UT)	21.8.2009

\* One SEIAA constituted for two UTs



Fig-25. A panoramic view of Gangotri

category projects pertaining to all the sectors to the respective SEIAAs for their consideration for prior environmental clearance. The twenty three State level Environment Impact Assessment Authorities (SEIAAs) accorded environmental clearance to seven hundred fifty nine projects in the year 2009 (up to December 2009).

#### Post Project Monitoring of Environment Clearance Conditions

Monitoring of projects with respect to conditions stipulated in the environmental clearance issued under EIA Notification 2006 and Coastal Regulation Zone 1991 is carried out through the six Regional Offices. The monitoring report is scrutinized in the Ministry and on that basis appropriate action is

contemplated under the Environment (Protection) Act, 1986 for violation of environmental clearance conditions. A procedure has been laid down for issuing showcause notice, closure of industry etc. in September 2009 which is placed on the website of the Ministry.

#### Interaction Meeting with SEIAA's

Two interaction meetings with the stakeholders were organized in the year 2009-10 at Guwahati and Chandigarh to discuss various issues pertaining to procedures and difficulties faced by the SEIAA's.

#### Preparation of EIA-Sector Specific Manuals

The Ministry of Environment and

Forests is in the process of preparation of thirty seven EIA manuals on sector specific developmental projects, which are listed in the Schedule to the EIA Notification 2006. The MoEF had uploaded Model TORs prepared for twenty of these sectors on the MoEF website inviting comments of various stakeholders involved in the environmental clearance (EC) process consisting of Screening, Scoping, Public Consultation and Appraisal of projects for the purpose of granting and expediting environmental clearance received under the Environment Impact Assessment (EIA) Notification 2006. These draft Manuals would serve as Guidance Manuals to various Sector specific Expert Appraisal Committees at the Centre and to State/UT Environment Impact Assessment Authorities (SEIAAs) and State Level Expert Appraisal Committees (SEACs) in the various States, who have been assigned the task of screening, scoping and appraisal of projects of various sectors for grant of environmental clearance. The Manuals on each Sector would help in standardization of the quality of appraisal and in reducing inconsistencies in appraisal of projects by EACs/SEACs/SEIAAs in granting ECs for similar projects at the Central and State level. The Manuals for each sector also include Model TORs, technological options, processes for a cleaner production, waste minimization, monitoring of environmental quality, related regulations, and procedure of obtaining EC if linked to other clearances for eg., CRZ, etc. The job of preparation of Manuals for thirty seven Sectors listed in the Schedule has been given to two institutions, namely Administrative Staff College of India (ASCI) and IL&FSS Ecosmart Ltd. Draft Final Manuals of fifteen Sectors have been prepared so far.

### Accreditation of the EIA consultants with Quality Council of India (QCI)/National Accreditation Board of Education and Training (NABET)

The Environmental Appraisal of Development Projects is undertaken as per the provisions of the Environment Impact Assessment Notification, 2006 based on the EIA/EMP Reports prepared by the project proponents in assistance with their Consultants. The good quality EIA Reports are pre-requisite for improved decision making. Therefore, all the Consultants/ Public Sector Undertakings (PSUs) working in the area of Environment Impact Assessment are required to get themselves registered under the scheme of Accreditation and Registration of the National Accreditation Board of Education and Training (NABET) and the Quality Council of India (QCI) by 30<sup>th</sup> June, 2010. No EIA/EMP Reports prepared by such Consultants who are not registered with NABET/QCI shall be considered by the Ministry after 30<sup>th</sup> June, 2010. After accreditation, the Consultants would need to include a certificate in this regard in EIA/EMP Reports prepared by them and data provided by other Organisations/Laboratories including their status of approvals etc. The EIA Consultants are advised to see further clarification on the subject through the website of NABET/QCI ([www.qcin.org](http://www.qcin.org))

### Coastal Management Zone (CMZ) Notification, 2008

The Ministry had issued the draft Coastal Management Zone (CMZ) Notification, 2008 under Environment (Protection) Act, 1986 inviting comments from the public. On the draft CMZ Notification

## Ministry of Environment & Forests

large number of comments was received. To examine these comments the Ministry constituted a four member Committee under the chairmanship of Prof. M.S. Swaminathan on 15<sup>th</sup> June, 2009. The Committee submitted its report on 15<sup>th</sup> July, 2009 after holding detailed discussions with the concerned stakeholders. The major recommendations of the Committee included, (i) to let the draft Coastal Management Zone Notification, 2008 lapse, (ii) stringent implementation of the Coastal Regulation Zone Notification, 1991 and use of space technology –enabled enforcement of the provisions of the notification, (iii) enhance protection of

fishermen communities, (iv) introduce regulations to manage the proliferation of ports along the coasts, (v) tighter standards for disposal of effluents in to coastal waters, (vi) new management regimes for Andaman, Nicobar and Lakshadweep Islands, (vii) include the seaward side to insure protection from current and future threats, (viii) measures to strengthen research and regulatory capacity, (ix) introduce policies keeping in view the future dangers from sea level rise and increased vulnerability of the coasts.

The Ministry has accepted the recommendations of the Report and initiated steps for implementing the same. Further, the



Fig-26. Protection structure to prevent coastal erosion

Ministry has also held consultations with the fishermen communities at Mumbai, Goa and Chennai. Further, consultations in other States will be held between January to March 2010. Based on the discussions and taking in to account the recommendations of the Prof. M.S. Swaminathan Committee as indicated above, the Coastal Regulation Zone Notification will be further strengthened.

### Integrated Coastal Management Zone (ICMZ) project of World Bank

An Integrated Coastal Zone Management (ICZM) project of World Bank has been initiated with financial assistance from the World Bank which has following three major components:

- (i) Vulnerability and Ecologically Sensitive Area Mapping;
- (ii) National Institute Building and Capacity Strengthening;
- (iii) Development and Implementation of State Level approaches to Integrated Coastal Zone Management on pilot scale in the States of Gujarat, West Bengal and Orissa.

The project is under implementation and studies have been initiated relating to Methodology for mapping and delineation of ecologically sensitive areas, management effectiveness of coastal zone environmental projects etc. The project preparation facilities have been established at MoEF and in the three States where pilot studies have been initiated. The project is at present in Project Preparation Facility mode under which Detailed Report for each of the component have been prepared. EFC Memo for the above

projects has been drafted for further necessary approvals.

### Ecologically Sensitive Areas

#### Introduction

Environmentally Sensitive Zones may be defined as areas with identified environmental resources having "Incomparable Values" which require special attention for their conservation. The Ministry has already notified ecologically-sensitive areas in respect of Matheran, Mahabaleshwar-Panchgani, Doon Valley, Taj Trapezium, Numaligarh, Aravalli and Dhanu Taluka under the Environment (Protection) Act, 1986. Zonal Master Plan / Area Development Plan for all notified / to be notified environmentally sensitive areas would be prepared by the concerned State Governments as per the provisions of the said respective draft notifications involving local communities / experts and got approved by the Ministry for regulating development activities and protection and conservation of Entities of Incomparable Values. Monitoring Committees with representatives of Government, Experts and local representatives as per the notifications would be constituted to ensure compliance of approved Zonal Master Plans/ Area Development Plan.

#### Objectives

- a) In order to conserve and enhance these resources, without impending legitimate socio-economic development of these areas, the following actions will be taken:
  - Identify and give legal status to Environmentally Sensitive Zones in the country having environmental entities with "Incomparable values"

requiring special conservation efforts.

- Formulate development plans for these zones on a specific basis, with adequate participation by the local communities.
- Create local institutions with adequate participation for the environmental management of such areas, to ensure adherence to the approved area development plans, which should be prepared in consultation with the local communities.

b) Adopt “best practice” norms for infrastructure construction in mountain regions to avoid or minimize damage to sensitive ecosystems and despoiling of landscapes.

### Programmes / achievements made during the year

- The Final Notification to declare Mount Abu (Rajasthan) as Eco-Sensitive Zone has been published in the Gazette of India. The Monitoring Committee has been constituted for the same.
- Areas around National Parks / Sanctuaries in Haryana are considered for the declaration as Eco-Sensitive Zones and the Draft Notifications in respect of Kalesar

National Park, Kalesar Wildlife Sanctuary, Khol Hi Raitan Wildlife Sanctuary, Bir Shikargarh Wildlife Sanctuary, Nahar Wildlife Sanctuary, Chhilchhila Wildlife Sanctuary, Abubshaher Wildlife Sanctuary, Bhindawas Wildlife Sanctuary and Khaparwas Wildlife Sanctuary have been published in the Gazette of India. Haryana State Government and local stakeholders have been made aware of the Notification.

- Areas around National Parks / Sanctuaries in Assam are considered for the declaration as Eco-Sensitive Zones and the Draft Notifications in respect of Kaziranga National Park, Bordoibam Beelmukh Bird Sanctuary and Panidehing Wildlife Sanctuary are in process.
- Areas around National Parks / Sanctuaries in Gujarat are considered for the declaration as Eco-Sensitive Zones and the Draft Notification in respect of Girnar Wildlife Sanctuary, Narayan Sarovar Sanctuary, Purna Wildlife Sanctuary are in process.
- Pachmari (Madhya Pradesh) is in various stages of being notified as Eco-Sensitive Zone.
- Monitoring Committees for Matheran and Mahabaleshwar–Panchgani have been reconstituted.



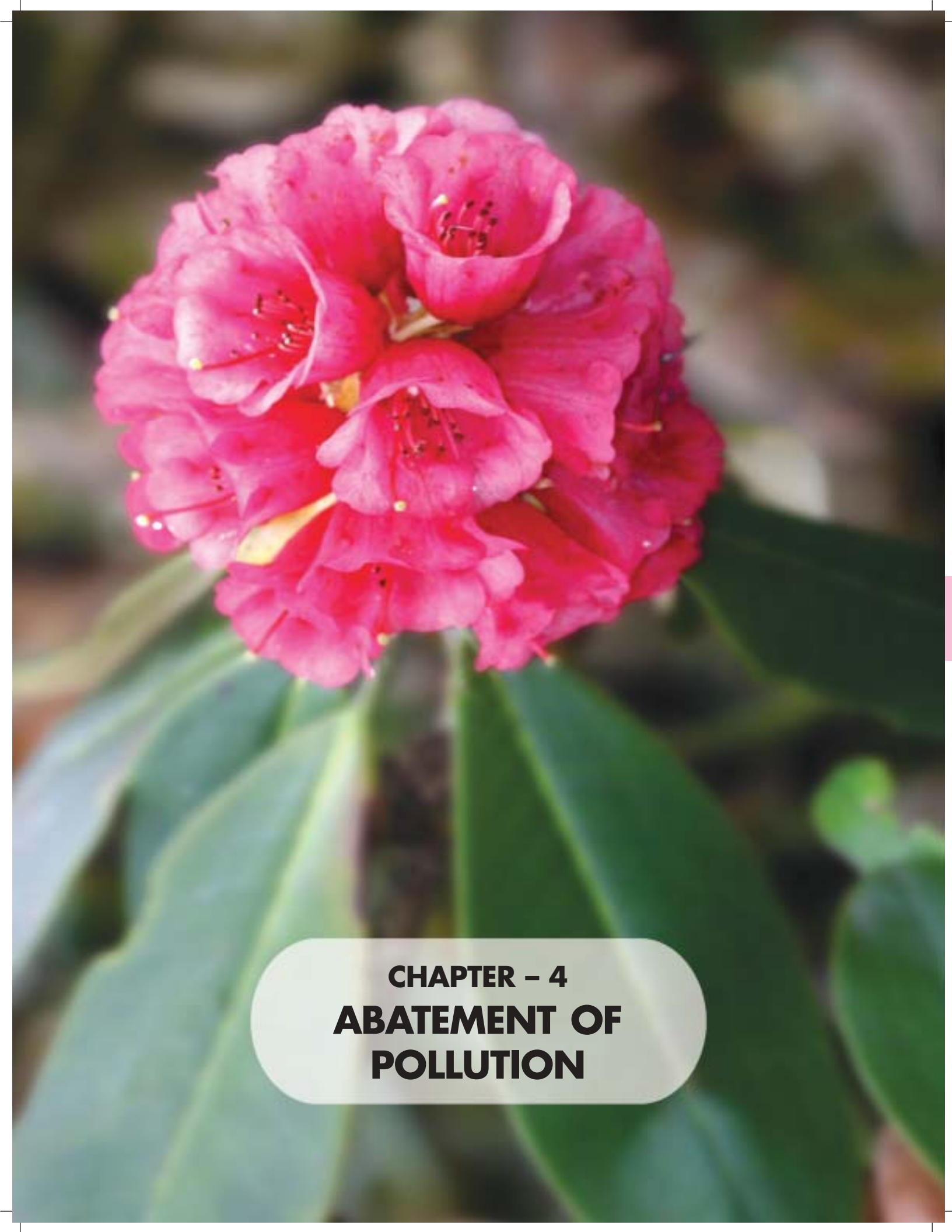

**CHAPTER - 4**  
**ABATEMENT OF**  
**POLLUTION**

## Control of Pollution

### Introduction

The concern for environmental quality has become the top most issue in the present scenario of rising population increasing urbanization, industrial and vehicular pollution as well as pollution of water courses due to discharge of effluents without conforming to the environmental norms and standards. Realising this trend of pollution in various environmental media like air, water, soil, etc. the Ministry earlier adopted Policy for Abatement of Pollution in 1992, which provides multi-pronged strategies in the form of regulations, legislation, agreements, fiscal incentives and other measures to prevent and abate pollution. To give effect to various measures and policies for pollution control, various steps have been initiated which, include stringent regulations, development of environmental standards & periodical revision therein, control of vehicular pollution, control of air & water pollution, spatial environmental planning, identification of critically polluted areas and improvement plans therein, etc. The Government also adopted National Conservation Strategy, 1992 and Policy Statement on Environment and Development, 1992. Afterwards, the Government adopted the National Environment Policy (NEP- 2006) which seeks to extend the coverage, and fill in gaps that still exists, in light of present knowledge and accumulated experience. This policy does not displace, but builds on the earlier policies of the Government. It lays emphasis on many new issues.

Progress of Activities Undertaken under various programmes is as follows:

### Control of Air Pollution

- The air pollution and the resultant air quality can be attributed to emissions from transportation, i.e. road, rail and airways, industrial and domestic activities. The air quality has been, therefore, an issue of social concern in the backdrop of various developmental activities. The norms for ambient air quality have been revisited and various industry specific emissions standards are evolved afresh or revisited and notified from time to time. For control of air pollution, with a view to initiate policy measures and to prepare ambient air quality management plans, three hundred sixty five ambient air quality monitoring stations are operational covering one hundred forty one cities/towns in twenty six States and five Union Territories. Presently, only the criteria pollutants namely; sulphur dioxide ( $\text{SO}_2$ ), nitrogen dioxides ( $\text{NO}_2$ ) and fine particulate matter ( $\text{PM}_{10}$ ) are monitored by the Pollution Control Boards, Pollution Control Committees, Universities and Research Institutes. Besides, additional parameters for other toxic trace matters and polycyclic aromatic hydrocarbons are also being monitored in selected cities of the country. Installation of automatic air quality monitoring stations is undertaken for twenty nine cities for continuous monitoring. Out of which the continuous monitoring has been introduced in thirteen cities namely; Agra, Kanpur, Varanasi, Lucknow, Mumbai, Bangalore, Howrah, Durgapur, Haldia, Kolkata, Pune, Solapur and Hyderabad, so far apart from Delhi. Twenty three manual monitoring

stations have been added in the network during the 2009-10.

- The monitored ambient air quality data while comparing with revised (NAAQS) indicates that the annual average levels of Sulphur Dioxide ( $\text{SO}_2$ ) are within the prescribed air quality norms in all cities and that of Nitrogen Dioxide ( $\text{NO}_2$ ) are within norms in most of the cities. However, the levels of fine particulate matter ( $\text{PM}_{10}$ ) exceed the prescribed norms in many cities including Delhi.

### Assistance for Abatement of Pollution

- Under this scheme, grants are being provided to the State Pollution Control Boards/UT Pollution Control Committees, Environment Departments, Central/State Research Institutes, and other government agencies/organizations with the aim of strengthening their technical capabilities to achieve the objectives of the Policy Statement. Assistance is also provided to North Eastern Pollution Control Boards & Pollution Control Committees as salary support for the technical staff. In addition, support is also extended for undertaking projects for Abatement of Pollution.
- During the 11<sup>th</sup> Plan period, financial outlay is to the tune of Rs. 45.00 crore and the financial allocation for the current financial year is Rs. 5.00 crore.
- Financial assistance has been extended to fifteen State Pollution Control Boards/UT Pollution Control Committees during the financial year.

### Auto Fuel Policy

- The Ministry of Petroleum and Natural Gas (MoP & NG), Government of India has

enunciated an Auto Fuel Policy which aims to comprehensively and holistically address the issues of vehicular emissions, vehicular technologies and auto fuel quality in a cost-efficient manner while ensuring the security of fuel supply. The Government has also published Gazette Notification vide G.S.R. 84(E) on 9<sup>th</sup> February 2009 for introducing Bharat Stage IV and III norms, as applicable, for new vehicles in selected cities. The Policy objectives include ensuring sustainable, safe, affordable and uninterrupted supply of auto fuels; optimum utilization of infrastructure for import of crude and crude products, processing and production, and the storage and transportation; assessing the future trends in emissions and air quality requirements from view point of public health; adopting such vehicular emission standards that will be able to make a decisive impact on air quality etc. The Policy provides for a road map for reduction in vehicular emission norms for new vehicles as well as for reduction of pollution from in-use vehicles. It also sets standards for quality of fuel and other kits. The road map for new vehicles given in Table -17.

### Source Apportionment Studies

- Due to multiplicity and complexity of air polluting sources, apportionment of contribution to ambient air pollution from these sources is important for planning cost effective pollution control strategies. In view of this, a study on "Air Quality Assessment, Emission Inventory/Source Apportionment Studies for Indian Cities" has been undertaken by the Government.

Table-17. New Auto Fuel Policy

Coverage	Passenger Cars, light commercial vehicles & heavy duty diesel vehicles	2/3 wheelers
Entire country	Bharat Stage II (Euro II equivalent) 01.04.2005 Bharat Stage III (Euro III equivalent) 01.04.2010	Bharat Stage III – Euro III equivalent – 1.4.2010
Eleven major cities (Delhi/NCR, Mumbai, Kolkata, Chennai, Bengaluru, Hyderabad, Ahmedabad, Pune, Surat, Kanpur & Agra)	Bharat Stage II (Euro II equivalent) 01.04.2003 Bharat Stage III (Euro III equivalent) 01.04.2005 Bharat Stage IV (Euro IV equivalent) 01.04.2010 (except for vehicles holding Inter-State permits or National Permits or All India Tourist permits)	

- To evaluate contribution from various sources to air quality, Source Apportionment Study (SAS) has been completed for six cities namely; Delhi, Bangalore, Chennai, Mumbai, Pune and Kanpur involving the institutions like National Environmental Engineering Research Institute (NEERI), Nagpur, The Energy and Resources Institute (TERI), New Delhi, Indian Institute of Technology (IIT), Chennai, Automotive Research Association of India (ARAI), Pune and Indian Institute of Technology (IIT), Kanpur. The objective frame work for Source Apportionment Study included preparation of emission inventory, emission profile, monitoring of ambient air quality, assessment of data and its authentication and source apportionment of RSPM (PM10) using factor analysis and receptor modeling etc. Application of Chemical Mass Balance (CMB-8) Receptor model and ISC dispersion model, have been used in the study.
- For appraisal and guidance during the survey and study, a National level Steering

Committee under the chairmanship of Secretary (E&F) has been constituted. In order to provide technical assistance and guidance during data collection, use of appropriate model etc. a Technical Committee has also been constituted under the chairmanship of Chairman, CPCB and members drawn from various technical institutions and organizations.

- An interim report of the study has been submitted to the Government. The final draft report is under international peer review before submission to Government.

### Development of Environmental Standards

- Environmental Standards refer both to the acceptable levels of specified environmental quality parameters at different categories of locations i.e. 'ambient standards' as well as permissible levels of discharge of specified waste streams by different classes of activities i.e. 'effluent standards' and discharges of gaseous pollutants i.e. emission standards.

- Environmental standards cannot be universal, and each country should set standards in terms of its national priorities, policy objectives, and resources, as stated in the National Environmental Policy, 2006. These standards, may, of course, vary (in general, become more stringent) as a country develops, and has greater access to technologies and financial resources for environmental management. Within the country different States, UTs and local bodies may adopt stricter standards, based on local considerations.
- In order to abate pollution from various sources, Ministry notifies general as well as industry specific emission and effluent standards for various categories of industries under the Environment (Protection) Rules, 1986 as per procedure specified in the Environmental (Protection) Act, 1986. Based on development of new pollution control technologies and their feasibility, these standards are reviewed from time to time and new ones are notified.
- All the notified Standards have been loaded on the website of this Ministry in a separate sub-head 'Environmental Standards' under 'Legislation' head. During the year, Environmental Standards in respect of following category of industries have been evolved and are being finalized for notification:
  - Incinerator Plants in Organic Chemicals Manufacturing units;
  - Petrochemical Plants;
  - Incinerator plants for Dye and Dye Intermediately units;

- Rubber product Industry;
- Grain processing Industry;
- Iron Ore Mines; and
- Copper and Zinc Smelters.

The source specific environmental standards have been notified for following industry/process have been notified during the year

#### *Effluent & Emission Standards*

- Cashew Seed Processing Unit (01.01.2010)

#### *Emission Standards*

- Brick Kilns (22.07.2009)
- Sulphur Recovery Unit (SRU) in Petroleum Oil Refinery (21.08.2009)
- Plaster of Paris Industry (05.02.2010)

#### *Effluent Standards*

- Pharmaceutical Industry (09.07.2009)
- Hotel Industry (04.11.2009)

The Government has also published a notification on the Revised National Ambient Air Quality Standards, 2009 in the official Gazette on 16<sup>th</sup> November, 2009. These ambient air quality standards/ limits provide a legal framework for the control of air pollution and the protection of public health.

The previously existing National Ambient Air Quality Standards (NAAQS) were notified for seven parameters i.e., Suspended Particulate Matter (SPM), Respirable Particulate Matter (RPM), Sulphur Dioxide (SO<sub>2</sub>), Oxides of Nitrogen (NO<sub>x</sub>), Carbon Monoxide (CO), Ammonia (NH<sub>3</sub>) and Lead (Pb). The review of the previous NAAQS and inclusion of new parameters was

undertaken by the CPCB in association with the Indian Institute of Technology, Kanpur. The proposal for revision in NAAQS was deliberated upon extensively. These revised standards include initiatives that have been developed in consonance with global best practices and in keeping with the latest advancements in technology and research. Some of the salient features include:

- Area classification based on land-use has been done away with so that industrial areas have to conform to the same standards as residential areas.
- The standards shall be applicable uniformly with the exception of stringent standards for  $\text{NO}_2$  and  $\text{SO}_2$  in the Ecologically Sensitive Areas.
- The previous standards for residential area have been uniformly applied for fine particulate matter ( $\text{PM}_{10}$ ), Carbon Monoxide and Ammonia. More stringent limits for Lead,  $\text{SO}_2$  and have been prescribed even for residential areas.
- Suspended particulate matter (SPM) as parameter has been replaced by fine particulate matter ( $\text{PM}_{2.5}$ ) which is more relevant for public health.
- Other new parameters, such as, Ozone Arsenic, Nickel, Benzene and Benzo(a) Pyrene (BaP) have been included for the first time under NAAQS based on CPCB/IIT research, World Health Organisation guidelines and EU limits and practices.

In furtherance of these Standards, the CPCB is in the process of creating a road-map for the generation and maintenance of required monitoring infrastructure and for the development of protocols.

## Noise Pollution

- Noise levels have been a matter of concern due to various activities, religious functions, festivals, marriages, processions and related celebrations. The main sources of noise pollution include industrial activities, use of public address system, construction activities, use of generator sets, pressure horns, fire crackers etc. Keeping in view the increasing trend in noise levels, Ministry has issued various regulations from time to time to control noise pollution in ambient air, at source and at manufacturing stage. To control community noise, Noise Pollution (Regulation and Control) Rules, 2000 were notified in February, 2000.
- In Civil Writ Petition No. 72 of 1998 regarding noise pollution-implementation of laws for retracting use of loudspeakers and high volume producing sound system, fire crackers etc, the Hon'ble Supreme Court in its judgement of July, 2005 and October, 2005 has given detailed directions regarding implementation of laws for controlling noise.
- In pursuance of the judgments and to collect bench mark data, all the regulatory agencies of the State Government/Union Territories are being regularly advised to comply with stipulated norms and to draw an Action Plan for ensuring the compliance of the directions of Hon'ble Court. The concerned agencies are regularly advised to strengthen/establish environmental cells at the State and district levels to check noise pollution an also to undertake surveys in major cities specially before and after the festivals to ensure compliance. A monitoring protocol for noise level and ambient air

monitoring especially during Deepawali festival was developed in 2008 with the help of CPCB and ambient noise and air quality monitoring has been undertaken by SPCBs, PCCs and CPCB across the country during Deepawali- 2009 in accordance with the said protocol.

– In pursuance of the aforesaid judgments of July 2005 and October 2005, draft rules have been published vide G.S.R. 158(e) on 9<sup>th</sup> March, 2009 for inviting public suggestion(s) within sixty days so as to amend existing Noise Pollution (Regulation and Control) Rules, 2009. Objections and suggestions were received from twenty two individuals, NGOs, resident welfare associations and Government Departments. The said objections and suggestions have been considered by the Government through an expert committee under the Chairmanship of Prof. S.P.Gautam, Chairman, CPCB. The final amendments to the Noise Rules, 2000 have been published in the official Gazette on 11<sup>th</sup> January, 2010. The salient features of this amendmend are:

- The stress has been laid to make the night peaceful. The night time has been defined (10.00 pm to 6.00 am) and restrictions have been imposed on the use of horns, sound emitting construction equipments and bursting of fire crackers during night time.
- Public place has been defined and the occupant of a public place would restrict the volume of public address system, etc so that noise emitting from its activity would not exceed the noise limit more than 10 dB (A), as applicable.

- Similarly, the occupant of a private place would restrict the volume of music system, etc so that noise emitting from its activity would not cause exceedance of noise limit more than 5 dB (A), as applicable.
- A duty has been cast upon the concerned State Governments to specify in advance, the number and particular of days on which two hours exemption (10.00 pm to 12.00 midnight) would be operative. State would be the unit for such an exemption.
- Noise emitting construction equipment have been specifically brought under the ambit of Noise Rules, 2000.

The CPCB has been advised for revisiting the national ambient noise standards and prepare a blue print to have national ambient noise monitoring network in place. A beginning to monitor ambient noise would be made during 2010-11, i.e. XI Plan in accordance with NEP-2006.

#### **Charter on Corporate Responsibility for Environmental Protection (CREP)**

- After a series of industry specific interaction meetings, the Charter on Corporate Responsibility for Environmental Protection (CREP) was adopted in March, 2003 for seventeen categories of polluting industries and it is a road map for progressive improvement in environmental management.
- For effective implementation of the Charter, eight taskforces comprising experts and members from institutions and industry associations were constituted. Three of them in respect of Thermal Power, Steel Sector

and Petroleum Oil Refinery have been reconstituted in 2009-10. These task forces are meeting regularly to monitor and to provide guidance to the industries for adopting necessary pollution abatement measures.

### **Comprehensive Environmental Pollution Index (CEPI) for Industrial Clusters**

The Ministry of Environment & Forests (MoEF) has adopted a Comprehensive Environmental Pollution Index (CEPI) system of environmental assessment of the eighty eight Industrial Clusters, evolved by the Central Pollution Control Board in collaboration with the IIT, Delhi (Table-18). CEPI may be used as a tool in synthesizing the available information on environmental status of areas by using quantitative criteria and its ability to reduce complex information into smaller and more easily retained information. CEPI could help in determining the effectiveness and comparing alternative plans and policies and assists environmental decision-makers in initiating appropriate measures in grading polluted industrial clusters. An increasing value of CEPI indicates severe adverse environmental decision-makers in initiating appropriate measures in grading polluted industrial clusters. An increasing value of CEPI indicates severe adverse effects on environment as well as an indication of a large proportion of population experiencing health hazards. The present CEPI system is intended to be used as an early warning tool for categorizing industrial clusters/ areas in terms of the severity of the overall pollution levels. On a scale of zero to one hundred, the industrial clusters having

aggregated CEPI scores of eighty and above have been considered as alarmingly polluted industrial clusters, the industrial clusters having aggregated CEPI scores of seventy to eighty have been considered as critically polluted industrial clusters, the industrial clusters having aggregated CEPI scores of sixty to seventy have been considered as seriously polluted and industrial clusters having aggregated CEPI scores of fifty to sixty fall in the warning zone. These areas need further detailed investigations in terms of the extent of damage and formulation of appropriate remedial action plan.

On the CEPI scale, forty three industrial clusters (CEPI scores > 70) out of eighty eight industrial clusters have been identified to be critically polluted areas and Action Plans are being prepared for forty three industrial clusters on priority basis. The effective implementation of the remedial action plan will help in abatement of pollution and to restore the environmental quality of these industrial clusters.

A Workshop was also organised on December 24, 2009 on "Comprehensive Environmental Pollution Index (CEPI) for Industrial Clusters". About two hundred participants from SPCBs/ PCCs, MoEF, CPCB, Scientific/ Technical institutions, NGOs, Industries Associations and Print & Electronic Media participated in the Workshop. The Hon'ble Minister released the two books entitled "Criteria for Comprehensive Environmental Assessment of Industrial Clusters" and "Comprehensive Environmental Assessment of Industrial Clusters" and also addressed the participants.



Table-18. The CEPI scores for industrial areas/clusters descending order

S.No.	Industrial Cluster/Area	Air	Water	Land	CEPI	
1.	Ankleshwar (Gujarat)	72.00	72.75	75.75	88.50	Ac_Wc_Lc
2.	Vapi (Gujarat)	74.00	74.50	72.00	88.09	Ac_Wc_Lc
3.	Ghaziabad (Uttar Pradesh)	68.50	75.25	71.50	87.37	Ac_Wc_Lc
4.	Chandrapur (Maharashtra)	70.75	67.50	66.50	83.88	Ac_Wc_Lc
5.	Kobra (Chhattisgarh)	67.00	57.00	72.50	83.00	Ac_Ws_Lc
6.	Bhiwadi (Rajasthan)	71.00	69.00	59.50	82.91	Ac_Wc_Ls
7.	Angul Talcher (Orissa)	64.00	69.00	65.75	82.09	Ac_Wc_Lc
8.	Vellore (North Arcot) (Tamil Nadu)	69.25	65.25	62.50	81.79	Ac_Wc_Lc
9.	Singrauli (Uttar Pradesh)	70.50	64.00	59.50	81.73	Ac_Wc_Ls
10.	Ludhiana (Punjab)	68.00	66.00	64.75	81.66	Ac_Wc_Lc
11.	Nazafgarh drain basin (including Anand Parvat, Naraina, Okhla and Wazirpur), Delhi	52.13	69.00	65.25	79.54	As_Wc_Lc
12.	Noida (Uttar Pradesh)	65.75	64.00	60.00	78.90	Ac_Wc_Lc
13.	Dhanbad (Jharkhand)	64.50	59.00	65.50	78.63	Ac_Ws_Lc
14.	Dombivalli (Maharashtra)	66.00	63.50	57.50	78.41	Ac_Wc_Ls
15.	Kanpur (Uttar Pradesh)	66.00	63.50	56.00	78.09	Ac_Wc_Ls
16.	Cuddalore (Tamil Nadu)	54.00	65.25	64.00	77.45	As_Wc_Lc
17.	Aurangabad (Maharashtra)	64.75	60.50	59.50	77.44	Ac_Wc_Ls
18.	Faridabad (Haryana)	63.50	59.00	62.75	77.07	Ac_Ws_Lc
19.	Agra (Uttar Pradesh)	59.00	63.75	59.50	76.48	As_Wc_Ls
20.	Manali (Tamil Nadu)	64.00	59.00	58.00	76.32	Ac_Ws_Ls
21.	Haldia (West Bengal)	53.75	64.50	57.00	75.43	As_Wc_Ls
22.	Ahmedabad (Gujarat)	62.75	58.00	58.00	75.28	Ac_Ws_Ls
23.	Jodhpur (Rajasthan)	52.00	65.50	54.00	75.19	As_Wc_Ls
24.	Cochin, Greater (Kerala)	57.00	64.00	54.00	75.08	As_Wc_Ls
25.	Mandi Gobind Garh (Punjab)	62.00	55.50	62.00	75.08	Ac_Ws_Lc
26.	Howrah (West Bengal)	57.00	54.50	63.50	74.84	As_Ws_Lc
27.	Vatva (Gujarat)	60.00	62.00	56.00	74.77	Ac_Wc_Ls
28.	Ib Valley (Orissa)	61.00	56.50	59.00	74.00	Ac_Ws_Ls
29.	Varanasi - Mirzapur (Uttar Pradesh)	58.00	62.00	53.50	73.79	As_Wc_Ls
30.	Navi Mumbai (Maharashtra)	61.00	59.00	55.50	73.77	Ac_Ws_Ls
31.	Pali (Rajasthan)	52.00	64.00	52.00	73.68	As_Wc_Ls

## Ministry of Environment & Forests

S.No.	Industrial Cluster/Area	Air	Water	Land	CEPI	
32.	Manglore (Karnataka)	61.75	57.75	54.00	73.34	Ac_Ws_Ls
33.	Jharsuguda (Orissa)	61.00	56.50	56.00	72.38	Ac_Ws_Ls
34.	Coimbatore (Tamil Nadu)	62.25	58.75	45.50	72.33	Ac_Ws_Ln
35.	Bhadravati (Karnataka)	62.75	56.50	45.50	72.01	Ac_Ws_Ln
36.	Tarapur (Maharashtra)	60.75	56.00	51.25	71.91	Ac_Ws_Ls
37.	Panipat (Haryana)	55.75	56.50	59.00	71.26	As_Ws_Ls
38.	Indore (Madhya Pradesh)	59.00	57.50	52.00	70.99	As_Ws_Ls
39.	Bhavnagar (Gujarat)	54.50	57.50	57.75		As_Ws_Ls
40.	Vishakhapatnam (Andhra Pradesh)	57.00	57.50	55.00	70.82	As_Ws_Ls
41.	Junagarh (Gujarat)	53.25	52.50	59.50	70.82	As_Ws_Ls
42.	Asansole (West Bengal)	58.38	56.25	50.50	70.20	As_Ws_Ls
43.						
44.	Paradeep (Orissa)	54.00	58.50	48.00	69.26	As_Ws_Ln
45.	Nashik (Maharashtra)	55.00	57.50	50.25	69.25	As_Ws_Ls
46.	Chembur (Maharashtra)	59.75	50.75	46.00	69.19	As_Ws_Ln
47.	Baddi (Himachal Pradesh)	56.00	54.50	54.50	69.07	As_Ws_Ls
48.	Kala Amb (Himachal Pradesh)	56.75	54.50	51.00	68.77	As_Ws_Ls
49.	Dewas (Madhya Pradesh)	51.50	57.50	51.50	68.77	As_Ws_Ls
50.	Batala (Punjab)	51.00	56.50	54.50	68.59	As_Ws_Ls
51.	Tirupur (Tamil Nadu)	56.75	50.75	53.00	68.38	As_Ws_Ls
52.	Durgapur (West Bengal)	49.50	58.50	47.50	68.26	An_Ws_Ln
53.	Raichur (Karnataka)	59.75	46.50	44.50	68.07	As_Wn_Ln
54.	Bidar (Karnataka)	58.75	49.00	44.00	67.64	As_Wn_Ln
55.	Singhbhum, West (Bihar)	55.50	51.50	51.50	67.30	As_Ws_Ls
56.	Mettur (Tamil Nadu)	46.00	58.00	46.50	66.98	An_Ws_Ln
57.	Vadodara (Gujarat)	57.00	48.00	48.00	66.91	As_Wn_Ln
58.	Jaipur (Rajasthan)	55.00	52.00	50.50	66.82	As_Ws_Ls
59.	Rajkot (Gujarat)	45.50	54.50	55.50	66.76	An_Ws_Ls
60.	Nagda – Ratlam (Madhya Pradesh)	44.50	54.50	56.00	66.67	An_Ws_Ls
61.	Jamshedpur (Jharkhand)	55.75	55.50	42.00	66.06	As_Ws_Ln
62.	Pimpri-Chinchwad (Maharashtra)	55.25	52.50	46.00	66.06	As_Ws_Ln
63.	Raipur (Chhattisgarh)	56.50	42.00	49.00	65.45	As_Wn_Ln
64.	Saraikela (Jharkhand)	50.50	49.00	54.00	65.38	As_Wn_Ls

S.No.	Industrial Cluster/Area	Air	Water	Land	CEPI	
65.	Ramgarh (Jharkhand)	44.00	53.00	54.50	65.11	An_Ws_Ls
66.	Pinia (Karnataka)	56.75	46.00	42.00	65.11	As_Wn_Ln
67.	Pitampur (Madhya Pradesh)	47.75	54.00	50.50	65.09	An_Ws_Ls
68.	Jalandhar (Punjab)	52.00	52.00	52.00	64.98	As_Ws_Ls
69.	Moradabad (Uttar Pradesh)	54.00	49.00	47.50	64.71	As_Wn_Ln
70.	Bada Jamtara (Jharkhand)	48.00	52.50	52.50	64.47	An_Ws_Ls
71.	Aligarh (Uttar Pradesh)	53.00	48.00	48.00	63.83	As_Wn_Ln
72.	Parwanoo (Himachal Pradesh)	53.00	47.50	48.50	63.83	As_Wn_Ln
73.	Haridwar (Uttarakhand)	51.75	48.00	40.00	61.01	As_Wn_Ln
74.	Vijaywada (Andhra Pradesh)	52.00	41.50	43.00	60.57	As_Wn_Ln
75.	Ferozabad (Uttar Pradesh)	49.00	47.00	47.75	60.51	An_Wn_Ln
76.	Mathura (Uttar Pradesh)	48.00	48.00	48.00	59.98	An_Wn_Ln
77.	Meerut (Uttar Pradesh)	50.00	47.50	39.50	59.38	As_Wn_Ln
78.	Erode (Tamil Nadu)	47.38	47.25	43.50	58.19	An_Wn_Ln
79.	Surat (Gujarat)	46.00	46.75	45.50	57.90	An_Wn_Ln
80.	Kathedan (Andhra Pradesh)	44.50	47.00	45.50	57.73	An_Wn_Ln
81.	Kukatpalli (Andhra Pradesh)	41.50	47.00	43.50	56.56	An_Wn_Ln
82.	Hajipur (Bihar)	43.50	44.00	44.50	55.12	An_Wn_Ln
83.	Gwalior (Madhya Pradesh)	45.88	38.50	42.00	54.63	An_Wn_Ln
84.	Udhamsingh Nagar (Uttarakhand)	44.00	41.25	44.25	54.37	An_Wn_Ln
85.	Bhillai – Durg (Chhattisgarh)	44.00	35.00	33.50	50.57	An_Wn_Ln
86.	Bulandsahar –Khurza (Uttar Pradesh)	42.00	33.50	36.50	49.09	An_Wn_Ln
87.	Burnihat (Assam)	39.00	34.50	34.50	46.26	An_Wn_Ln
88.	Digboi (Assam)	32.00	32.75	38.00	44.55	An_Wn_Ln

### Recognition of Environmental Laboratories under Environment (Protection) Act, 1986

– The successful implementation of environmental protection programmes essentially requires to identify and quantify the pollution sources and pollutants, conduct baseline survey, lay down standards and build-up monitoring systems. To meet these

requirements an environmental laboratory requires to be provided with all the necessary instruments and equipments as also expertise and capability of its staff for monitoring all groups of parameters including water, air, noise, hazardous waste, soil, sludge etc.

– For effective implementation of environment protection programmes there is an

inescapable need for an efficient and reliable institutional arrangement and facilities for survey, identification, quantification and systems for monitoring. In this context, the role of an environmental laboratory assumes paramount importance and significance especially for the assessment of the status of environment and its components and can facilitate effectively in prevention and control of pollution. The Ministry has been implementing a programme for recognition of environmental laboratories with the aim of increasing facilities for analysis of environmental samples.

### Revision of Guidelines for Evaluation and Recognition of Environmental Laboratories under E (P) A, 1986.

– The extant guidelines (1994-95) for establishment and recognition of the laboratories have been revised and procedures streamlined. The revision had become necessary as the Environment (Protection) Act, 1986 has been strengthened over the years with the enactments of various rules and notifications there under. Further, environmental standards have been formulated for various parameters in different industrial sectors. The guidelines for recognition of environmental laboratories under E(P)A 1986 have been revised by the Ministry with emphasis laid on quality assurance and quality control aspects. The revised guidelines have been placed on the website of Ministry ([www.envfor.nic.in](http://www.envfor.nic.in)) for wider circulation. The revised guidelines (June 2008) are a definite improvement in the content and the procedures for recognition of the environmental laboratories.

- On the whole, through these revised guidelines, an attempt has been made to bring in synergy in requirements between the three Environmental Acts, viz the Water (Prevention and Control of Pollution) Act, 1974, the Air (Prevention and Control of Pollution) Act 1981 and the Environment (Protection) Act, 1986. Under the provisions of Section 12 and 13 of E(P)Act, 1986, the private laboratories are considered by the Ministry of Environment & Forests (MoEF) for recognition.
- The revised guidelines have been operationalised. The Expert Committee on Labs is meeting once every month to discuss all the cases of Government and Private Sector Labs.
- During the year ten private laboratories were considered for recognition under E(P)Act, 1986.

### Common Effluent Treatment Plants (CETPs)

- The concept of the Common Effluent Treatment Plants (CETP) arose in order to make a co-operative movement for pollution control. The main objective of the CETPs is to reduce the treatment cost to be borne by an individual member unit to a minimum while protecting the water environment to a maximum. Wastewater treatment and water conservation are the prime objectives of the CETP. The concept of CETPs was envisaged to treat the effluent emanating from the clusters of compatible small - scale industries. It was also envisaged that burden of various Government authorities working for controlling pollution and monitoring of water pollution could be reduced once the CETPs are implemented and commissioned.

- A Centrally Sponsored Scheme has been undertaken by the Government for enabling the small scale industries (SSI) to set up new and upgrade the existing Common Effluent Treatment Plants (CETP) to cover all the States in the country. A scheme for financial assistance for the CETPs has been formulated as follows:
  - State subsidy – 25% of the total project cost;
  - Central subsidy – 25% of the total project cost;
  - Entrepreneurs contribution – 20% of the total project cost;
  - Loan from financial institutions – 30% of the total project cost;  
(e.g., IDBI, ICICI or any other nationalized banks, State Industrial Financial Corporation etc.)
- During this year, an allocation of Rs. 4.97 crore was made for providing financial assistance to the on-going CETP projects and for new projects. Financial assistance was provided for the ongoing projects namely, Mahad, Waluj in Maharashtra. Nacharam in Andhra Pradesh, and Palsana, Pandesara in Gujarat.

### Taj Protection Mission

- In pursuance of the Hon'ble Supreme Court's Order, projects for environmental protection of World Heritage Site of Taj Mahal were initiated and funded by the Ministry. The Planning Commission approved Rs.600 crore on a 50:50 cost sharing basis with the State Government to implement various schemes in the Taj Trapezium Zone for environmental protection of the Taj Mahal. In the first phase

during the IX Five Year Plan, ten projects were approved by the Government to be implemented by the State Government of Uttar Pradesh.

- The Ministry has sponsored a post-evaluation study for completed projects through the National Environmental Engineering Research Institute (NEERI), Nagpur for ascertaining the improvement in environmental status of the area. The revised report of the study by NEERI is under examination.

### Eco-cities

- The Eco-cities Project aims at improving the existing environment and at changing those aspects that are causing environment damage. The focus of the project includes protection of environmental resources like water bodies, forests etc., improving infrastructure and sanitary conditions in the towns and creating aesthetic environs.
- The Eco-cities Programme was initiated to bring in visible environmental improvement in the small and medium towns. The following towns were taken under first phase of Eco-cities programme to bring in visible environmental improvement:
  - Vrindavan (Uttar Pradesh)
  - Tirupati (Andhra Pradesh)
  - Puri (Orissa)
  - Ujjain (Madhya Pradesh)
  - Kottayam (Kerala)
  - Thanjavour (Tamil Nadu)
- An Expert Committee has been constituted for the identification of the projects and approval of Environmental Developed Plan (EDP) and Detailed Projects Reports. The

project in Kottayam is aimed at rejuvenating Mundar River and Kacherikadavu Boat Jetty and Canal that have severe siltation and pollution problems. The Project in Ujjain is aimed at improvement around Mahakal Temple and cleaning of Rudra Sagar lake, which is highly silted and polluted with sewage. While the project in Vrindavan aims at improvement of historic core of the town located around Rangnath Temple, the project in Tirupati is for improvement of storm water drains in the northern, southern and western side of the Gobind Raja Swamy Temple. Similarly, Project in Puri is to improve around Jagannath Temple, renovation of three of the religious ponds, shifting of garages and automobile workshop and improvement of existing solid waste disposal facility. In Thanjavur towns, the activity on 'Renovation of old tanks' has been proposed to be taken up to protect presently used and potentially useable aquifers from further degradation and to facilitates the rainwater harvesting system.

- The Eco-city Programme has been continued during the Eleventh Five Year Plan Period with inclusion of three more towns/cities namely, Chanderi (M.P.) Sawai Madhopur (Rajasthan) and Darjeeling (W.B.). The concerned Urban Local Bodies (ULBs) and the State Pollution Control Boards (SPCBs) have been asked to take further necessary action for implementation of various projects under this programme.

### **Industrial Pollution Abatement through Preventive Strategies**

Four important activities are going on under this sub-scheme

- Waste Minimization for small & medium scale industries;

- Environmental Audit;
- Environmental Management;
- Environmental Statistics & Mapping.

### **Environmental Authorities**

#### **Environment Pollution (Prevention Control) Authority for the National Capital Region**

- The Environment Pollution (Prevention and Control) Authority (EPCA) for National Capital Region was constituted under sub-section (3) of Section 3 of the Environment Protection Act, 1986 on January 29, 1998 vide S.O. No. 93(E) dated January 29, 1998 under the chairmanship of Sh. Bhure Lai. The tenure of the EPCA was extended from time to time, and at present extended upto 28<sup>th</sup> Jan. 2010 vide S.O. 1839 (E) dated 27<sup>th</sup> July 2009.
- The issues considered by the Authority include environment related matters covering vehicular pollution control, sewage treatment and assessment of operations and handing over of Common Effluent Treatment Plants (CETPs) in NCR to the concerned societies, monitoring of action plans for improvement of air quality in seven metro cities etc. and in addition, the matters referred to it by Hon'ble Supreme Court in its various Judgments.
- EPCA is reporting the compliance status and special tasks assigned to it to the Hon'ble Supreme Court from time to time.

#### **National Environment Appellate Authority (NEAA)**

The National Environment Appellate Authority (NEAA) was establish under the National Environment Appellate Authority Act,

1997 (22 of 1997) to hear appeals in regard to restriction of areas in which any industries, operations or class of industries, operations or process shall not be carried out or shall be carried out subject to certain safeguards under the Environment (Protection) Act, 1986 and for matter connected therein or accidental thereto.

#### Loss of Ecology (Prevention and payments of Compensation) Authority for the State of Tamil Nadu

In compliance with the Hon'ble Supreme Court's order dated August 28, 1998 in Writ Petition (Civil) No. 914 of 1991 viz. Velioire Citizen's Welfare Forum versus Union of India and Others, the Ministry constituted the Loss of Ecology (Prevention and Payments of Compensation) Authority for the State of Tamil Nadu under the Chairmanship of a retired Judge of Madras High Court vide notification SO 671 (E) dated September 30, 1996, to deal with the situation created by the tanneries and other pollution industries in Tamil Nadu. The tenure of the authority has been extended up to December 28, 2010 vide Notification SO. 3317 (E) dated 31.12.2009

#### Water Cess

– Water Cess is levied on water consumed by persons carrying on certain industries and local authorities with a view to augment the resources of Central Pollution Control Board (CPCB), State Pollution Control Boards (SPCB) and Pollution Control Committees in UTs for the prevention and control of water pollution. The proceeds of the Cess levied are first credited to the Consolidated Fund of India and after that the Central Government makes available the proceeds to SPCBs and PCCs.

– During the year an amount of Rs.204.00 crore were collected by SPCBs/PCCs and Rs.81.80 crore were reimbursed to different SPCBs and PCCs by the Central Government.

#### Fly Ash Utilization

Fly ash is the finely divided mineral residue resulting from the combustion of ground powdered coal in electric generating plant. Fly ash consists of inorganic matter present in the coal that has been fused during coal combustion. The fast increasing demand of power coupled with its dependence on coal for at least 2/3<sup>rd</sup> of its energy requirement is generating large volume of fly ash. Generation of about forty million tonnes fly ash during 1994 increased to about one hundred million tonne/year by 2001 and one hundred and thirty million tonne in 2007. The projections made by Planning Commission as well as Ministry of Power upto 2031-32 indicate that 2/3<sup>rd</sup> of power generation in the country would continue to depend on coal. The annual generation of fly ash is expected to be around one hundred seventy five million tonne by end of XI<sup>th</sup> Five Year Plan Period, two hundred twenty five million tonne by end of XII<sup>th</sup> Five Year Plan Period and around five hundred million tonne by 2031-32.

The first Fly Ash Notification was issued by Ministry of Environment & Forests in September 1999 to regulate the disposal of fly ash and ensure its proper utilization. A second Notification making amendments was issued in August, 2003.

The implementation of this Notification since 1999 resulted in steady increase in the utilization of flyash. However, the utilization has not reached to 100%. Therefore, certain

additional measures were required to further promote and facilitate its use.

### Objectives

- To protect environment
- To conserve top soil
- To prevent dumping of fly ash from Thermal Power Stations on land
- To promote utilization of ash in the manufacture of building materials and construction activity

### Progress and achievements made during the year

The Fly Ash Utilisation Notification was issued by Ministry of Environment and Forests in September 1999 to regulate the disposal of fly ash and ensure its proper utilization. Restriction was imposed to the extent that all brick kilns within the radius of fifty kilometers from coal/lignite based thermal power plants should use 25% fly-ash while making the bricks. The same was issued as per the orders of the Hon'ble High Court of Delhi in September, 1999. A second Notification making amendments was issued in August, 2003 increasing the radius from the thermal power plants to 100 kms.



The Ministry has issued the amendment notification No. S.O. 2804(E) dated 03.11.09 to amend the existing fly ash notification of 1999 as amended in the year 2003. The main amendments proposed in the notification include the following:

- The clay brick manufacturers have been excluded from the purview of this notification, as they are usually in the unorganized sector and the utilization of fly ash by them is not significant. The

construction agencies engaged in the construction of buildings have been made responsible for use of only fly ash based products for construction.

- The minimum fly ash content for building material / products to qualify as "fly ash based products" category has been stipulated.
- Use of certain minimum percentage of fly ash for stowing of underground mines and backfilling of opencast mines has been made mandatory.
- All Coal / Lignite based thermal power plants have been allowed to sell fly ash to the user agencies except the pond ash and mound ash which should be made available free of cost.
- In addition, at least 20% of dry ESP fly ash should also be made available free of charge to the fly ash or clay fly ash bricks, tiles & blocks manufacturers on priority basis.
- Fly ash utilization targets for thermal power plants / expansion of plants commissioned before and after issue of this notification, have been stipulated.
- A Monitoring committee to monitor the implementation of the provisions of the notification and submit its recommendations / observations every six months has been proposed.
- All the Financial institutions and agencies which fund construction activities shall include a clause in their loan / grant document for compliance of the provisions of this notification.

All the State Governments have been made aware of the draft Amendment



Notification and further instructed to sensitise all concerned with the said draft notification.

## Environmental Health

### Introduction

The urban environmental degradation, through lack of (or inappropriate) waste treatment and sanitation, industry and transport related pollution, adversely impacts air, water, and soil quality, and differentially impacts the health of the urban poor. This, in turn, affects their capability to seek and retain employment, attend school, and enhances gender inequalities, all of which perpetuate poverty.

It is increasingly evident that poor environmental quality has adversely affected human health. Environmental factors are estimated as being responsible in some cases for nearly 20 percent of the burden of disease in India, and a number of environment-health factors are closely linked with dimensions of poverty (e.g. malnutrition, lack of access to clean energy and water). It has been shown that interventions such as reducing indoor air pollution, protecting sources of safe drinking water, protecting soil from contamination, improved sanitation measures, and better public health governance, offer tremendous opportunities in reducing the incidence of a number of critical health problems.

The National Environment Policy is a response to our national commitment to a clean environment, mandated in the Constitution in Articles 48 A and 51 A (g), strengthened by judicial interpretation of Article 21. It is recognized that maintaining a healthy environment is not the State's responsibility alone, but also that of every

citizen's. Human beings are at the centre of concerns for sustainable development. They are entitled to a healthy and productive life in harmony with nature.

### Objectives

In order to protect the human health from the impacts of pollutants, efforts may be made to co-relate the manifestations of various diseases with the environmental factors especially respiratory diseases & cardiovascular diseases contracted due to exposure to various pollutants. As such, the long term studies (cohort studies) to find out any co-relationship between the dose and the response would be useful for evolving the strategies for the protection of human health.

The key benefit will help in evolving strategies for health risk reduction. It will also strengthen the comprehensive approach to the environmental health management plans, which would be a systematic approach to estimate the burden of disease and injury due to different environmental pollutants.

## Development & Promotion of Clean Technology

### Introduction and objectives

Clean Technologies, as distinct from "end-of-pipe" abatement technologies minimize the generation of waste streams in the production processes and utilize waste from other consumption goods and production processes, rather than treating the waste after generation. In general, clean technologies are less intensive in use of raw materials and energy, than conventional technologies, which rely on pollution abatement after generation. For this reason, they may also offer significant cost advantages to the producer.

“Adoption of cleaner technologies and cleaner production strategies is considered to provide a balance between Development & Environment through economic benefits by way of increased resource efficiency, innovation and reduced cost for environmental management”. A grant-in-aid Scheme on Development and Promotion of Clean Technologies was initiated in 1994 with the following objectives:-

- Development & Promotion of Cleaner Technologies.
- Development of Tools and Techniques for Pollution Prevention.
- Formulation of Sustainable Development Strategies

### Activities undertaken and completed



Since the inception of the scheme in 1994, activities undertaken include (i) Carrying Capacity Studies in various parts of the country namely Greater Kochi Region, Doon Valley, Damodar River Basin, Tapi Estuary and National Capital Region (NCR); (ii) Natural Resource Accounting Studies for Upper Yamuna Basin; (iii) Life Cycle Assessment (LCA) Studies in Thermal Power Plants, Steel, Pulp and Paper and Cement (from cradle to gate). 2<sup>nd</sup> phase of the project i.e. gate to grave is continuing during the current financial year (iv) Other pollution prevention, waste utilisation and management studies.

Three Demonstration projects mentioned below are at final stage and are likely to be completed during the current financial year.

- “Development of Air Pollution Control Package for Small Scale Lime Kilns by

National Environmental Engineering Research Institute (NEERI), Nagpur.

- “Design and Development of Computer Numerical Controlled Eco-friendly Welding Machine” by Annamalai University, Annamalai Nagar, Tamil Nadu.
- “Environment Pollution Control in Agro-based Paper Industry by implementation of Lignin Precipitation System (LPS) Technology” by ABC Papers, Hoshiarpur and Punjab Pollution Control Board, Patiala.

### Progress made during the year

- Under the grant-in-aid scheme on Development & Promotion of Clean Technology nine projects continued during the period and their progress was monitored through Monitoring Committee, followed by Workshops and Field Visits.
- Seventh meeting of the Evaluation and Monitoring Committee was held under the Chairmanship of Prof. L. Kannan in July, 2009. The Committee has recommended five projects for funding. These are as follows:

### Achievements in the current financial year

Three projects have been completed. These are:

- “Development of Adhesive from Bio-material”, IPIRTI, Bangalore.
- “Development of Natural Dyes from Forest Wastes”, ICFRE, Dehradun.
- “Recycling of Marble Slurry, Udaipur”, Rajasthan, IES, Delhi.

Findings of the above projects have been sent to Central Pollution Control Board,

Delhi and other organisations for implementation.

#### Brief summary of completed projects

#### Development of Adhesive from Bio-material by IPIRTI, Bangalore

The project was sponsored by the Ministry to Indian Plywood Industries Research & Training Institute (IPIRTI), Bangalore, for development of bio-adhesive for use in the manufacture of plywood drawn from biological materials like tannin from tree bark, cashew nut shell, liquid and lignin obtained from black liquor, wastes generated by Pulp and Paper Industry. Lignin and Tannin are two products obtained from tree. Both the products have certain characteristics similar to phenol. These properties of lignin and tannin have been utilized to develop bio adhesives in which phenol has been replaced partly in phenol formaldehyde resin. Bio adhesives so prepared have been successfully utilized in the manufacture of higher grade plywood. Although lignin reacts well with formaldehyde in combination with phenol but the rate of reaction and molecular nature of the resultant polymer differs in physical properties. In the present investigations, the industrial black liquor obtained from different sources was fractionated by membrane separations and were used in development of phenolic resins by partial replacement of phenol. Tannin is tree bark extract mostly used for converting skin into leather. Tannin contains phenolic unit which react with formaldehyde to polymerize into resin. Mimosa wattle tannin has been used in preparation of tannin formaldehyde resin for making particle board and also plywood fast curing mechanism of tannin, a low condensed phenol formaldehyde

resin was developed and extended with mimosa wattle tannin for the manufacture of plywood. This development yielded a cheaper adhesive and also could bond veneers of higher moisture content which conforms to boiling water proof grade. Use of high moisture content veneers for bonding veneer results in saving energy requirement for drying. Both the glue formulations have been found to be environment friendly. Since these bio constituent in the glue i.e. lignin and tannin replace phenol in the phenol formaldehyde resins the use of these wood adhesives, will reduce use of petro product – phenol whose price fluctuate over the year.

These technologies have been successfully demonstrated in plywood factories for the manufacture of highest grade of plywood and the products have been found to meet BIS specification.



Fig-27. Ultra filtration for molecular fractionation of lignin in black liquor

### Development of Natural Dyes from Forest Wastes by FRI, Dehra Dun

The Ministry of Environment and Forests has jointly sponsored a project Development of Natural Dyes from Forest Wastes the Forest Research Institute, Dehra Dun. The objectives of the project are Erection of a pilot plant for the isolation of natural dye from *Eucalyptus* hybrid (leaves and bark), *Populus deltoides* (bark), *Cassia tora* (seeds), *Pinus roxburghii* (needles) and *Lantana camara* (leaves). Use of synthetic dyes involves release of large amounts of hazardous chemicals during their production and subsequent use. With the environmentally benign products becoming a top priority in recent years, dye industry has turned its attention to newer products, which cater to fashion trends as well as to environmental specifications. Global annual demand of natural dyes is presently estimated to be about 10, 000 tons per annum. Thus prospecting for natural dyes was an urgent felt need. Pilot plant for extraction of natural dye was designed, erected and commissioned in 2004 at Chemistry Division, Forest Research Institute Dehradun to process 20-40 Kg of raw material. Laboratory processes were scaled at the pilot scale and yield of the dye was -*Eucalyptus* hybrid (leaves, 13.7% and bark 4.60%), *Populus deltoides* bark (6.5%), *Pinus roxburghii* dry needles (10.7%), *Lantana camara* leaves (15.3%) and *Cassia tora* seeds (6.0%). Dyeing methods have been standardized for dyeing of different fabrics, e.g., cotton, silk, wool with these dyes. A number of fascinating shades were developed on different fabrics using common mordants like alum, salt of iron, tin and chrome. The color fastness properties and CIE Lab values

of the dyed fabrics were also determined and comparable with the synthetic dyes. .

### Recycling of Marble Slurry Waste for Environmental Improvement by IES, Delhi

The Indian Environment Society (IES), New Delhi has implemented a pilot project on Recycling of Marble Slurry by setting-up a pilot plant at RICCO industrial Area at Amberi, Udaipur. The aim of the project is to demonstrate the use of slurry as resource and not waste. Marble is nothing but is Calcium Oxide (CaO), Magnesium Oxide (MgO), Silicate Oxide (SiO<sub>2</sub>), Ferric Oxide (Fe<sub>2</sub>O<sub>3</sub>) and Lithium Oxide (LiO) etc. the chemical composition of the marble varies from place to place.

The Society has set-up one brick making units at Kota while one at Udaipur. These units were given practical training to use the slurry into bricks and tiles manufacturing. The granite slurry is used at Kota for making bricks. The IES developed a machine of brick making in the first phase of the demonstration project. This machine was modified from the present brick making machine to meet the requirement of the slurry bricks. The bricks so produced were tested at various compositions of cement, sand and marble slurry. Ultimately a ratio of all the three were evolved which is 1:2:10,. After the bricks are produced, it has to go on to water treatment at three stages. Ultimately the bricks are dried in a shade to avoid sun for at least two weeks.

The bricks so produced from the slurry were sent to Central Building Research Institute, Roorkee for testing the quality, strength and water holding capacity. The

institute found these bricks as an excellent construction material and a viable option to replace the traditional bricks. The results have shown that the bricks produced from the Marble Slurry Waste are much better in quality, having more comprehensive strength and less water absorption capacity. The cost of the Marble Slurry is also comparable to the traditional bricks. The bricks produced from Marble Slurry require less cement (40%) for plaster and can be used as decorative bricks also. The Society has also developed different varieties of tiles from the slurry and this could be another use of Marble Slurry Waste

### **Industrial Pollution Abatement through Preventive Strategies (Waste Minimisation for Small & Medium Industries)**

#### **Introduction and objectives**

The policy statement for abatement of pollution lays emphasis on preventive aspects of pollution abatement and promotion of technical inputs to reduce industrial pollution. One of the simplest preventive strategies is to minimize the waste in production of products and goods. The main objective of waste minimization is to optimize the consumption of raw materials and also reduce waste generation by adopting production techniques which are cleaner in nature and which can be adopted by the existing units without necessarily changing the production processes or unit operations. The approach to the problem is towards utilizing the existing production facilities in an optimal manner. The objectives of the scheme are following:

- To assist the primary small units and some medium scale units who do not have access to the requisite technical expertise to

achieve waste minimization but excludes procurement of equipment and hardware.

- Establishing and running Waste Minimization Circles (WMCs) in clusters of Small & Medium Industries.
- Capacity building in the area of Waste Minimization/Cleaner Production through training.
- Waste Minimization demonstration studies in selected industrial sectors.
- Preparation of sector specific technical manuals on waste reduction, reuse and recycling.
- Awareness programmes and preparation of compendium of success stories on cleaner production/waste minimization

#### **Activities undertaken and completed**

The National Productivity Council (NPC), New Delhi coordinates the activities pertaining to Waste Minimisation Circles (WMCs) through facilitators designated by it, training and awareness activities by NPC itself as well as through Development Commissioner, Small Scale Industries (DC, SSI)., NPC has trained one hundred sixty eight participants in one hundred sixty two organisations through WMC facilitator Training programmes. NPC has also prepared compendium of success stories in this area for mass awareness and have also brought out through Centre or State level organizations or Consultants.

#### **Additional Activities undertaken in the Scheme**

- **Waste Minimization Circles**
  - Synergies would be drawn with other grant-in-aid schemes of this Ministry of

Environment & Forests, like demonstration projects, Clean Technology, etc.

- Mass dissemination of results of the studies in the area of waste minimization in industrial clusters across the country through electronic and print media.
- Sensitization of financial institutions like SIDBI, etc. through meetings and consultations for easy uptake of WM solutions by SMLs.
- **Waste Minimization Demonstration Projects** : As vast majority of the Small and Medium Industries (SMLs) in the country are still unaware of the benefits of waste minimization and resource conservation and its potential. The proposed activities would support the demonstration projects in designated industrial sectors. In order to spread geographically, it would be desirable to use the network of facilitators/capacity that is already built through Waste Minimization Circles.
- **Capacity Building on Waste Minimization** : The ongoing initiative needs to be regularly reviewed and strengthened by developing and implementing new strategies for waste minimization. The training programmes are integral part of the activity, in which the participating organizations facilitate in conducting such programmes. These training programmes need to be taken forward for a multiplier effect. Therefore, the current scheme shall support the following additional components namely:
  - “Training of the Trainer” programs on Waste Minimization
  - National and Regional Waste minimization Awareness Workshops

- **Developing Awareness Material on Waste Minimization** : In order to sustain various Waste Minimization efforts and to provide a continuing impetus to the programme, continued publicity and dissemination of the waste minimization activities is also proposed to be included in the scheme.
  - The sector specific training manuals and a compendium of success stories prepared by NPC are utilized in the dissemination of the findings and these are also made available in the NPC website. In addition to these, the site specific problems of some of the sectors are discussed during the training programmes.
  - Fifteen ongoing demonstration projects continued during the year 2009-10.

### Progress made during the year

Under the grant-in-aid scheme on “Abatement of Pollution through Preventive Strategies (Waste Minimisation)” eleven projects continued during the period and their progress was monitored through Monitoring Committee. These projects are as under:

- Waste Minimization Studies in Small Scale Industries in Balanagar Industrial Area, Hyderabad.
- Waste Minimization Studies in Small Scale Industries – Textile Sector in Nandigaon Village, Kothur Mahboobnagar Distt., Andhra Pradesh.
- Waste Minimization in small Scale Industries – WMC Extension – Phase II.
- Waste Minimization, Environmental Audit and Management System for the Industries and Regulatory Agencies.

- Minimization of Environmental impacts of Slaughter House Wastes by Value Addition as Pet Foods.
- Demonstration of Waste Minimization in Basic Chrome Manufacturing Unit.
- Clean Technology for Waste Minimization from Nutraceutical Industry.
- Waste Minimisation study in Electroplating Operation in Imitation Jewellery Unit Machilipatnam, Krishna Distt. Andhra Pradesh.
- "Biological Liquefaction of Waste Fleshing and Treatment with Tannery Effluent for Biogas Generation in Single Reactor".
- Enhancing the Environmental Performance and Competitiveness of Vegetable Oil Industry in Andhra Pradesh – Waste Minimisation (WM) Assessment, Demonstration of WM Measures, and Training".
- Waste Minimisation in Small Scale Industries.

The seventh meeting of the Evaluation and Monitoring Committee has recommended four projects for financial assistance. These are as follows:

- "Derivation of Engine Fuel from Waste Plastic and its Performance Evaluation" by the Department of Mechanical Engineering, Annamalai University, Annamalai Nagar (TN)
- "Waste Minimisation through co-composting of on and off-farm wastes for sustainable crop productivity and soil health" by Department of Soil Science and Agriculture Chemistry, Annamalai University, Annamalainagar.

- "Production of bioelectricity from sludge and domestic wastewater using microbial fuel cell" by University of Calcutta, Kolkata.
- "Waste Minimisation in Moradabad Brassware Cluster" by The Energy Resources Institute, New Delhi.

Besides the above, the Ministry of Environment and Forests has sponsored a project on Waste Minimisation in Small Scale Industries to National Productivity Council under the Waste Minimisation Policy Framework. The third phase of the project has been initiated since July 2007. As on date under Phases I, II, and III combined, a total of one hundred fifty three WMCs have been established across India addressing Small and Medium Enterprises (SMEs) from over sixty industrial sectors located in sixty industrial clusters/townships across seventeen states.

- Catalysed Group efforts (within and among industry associations) for WM
- Demand creation for more WMCs
- Engendering a new plan for networking etc. where research institutions, SPCBs, LPCs, private consulting firms and industry/firms, interacted through the WMC Framework sponsored by MoEF / World Bank and executed by NPC towards laying a strong and firm foundation for a WM movement.

#### Environmental Benefits achieved from the Project

- Reduction in water consumption : 10-35%
- Reduction in electricity consumption : 15-20%

- Reduction in fossil fuel consumption : 10-20%
- Reduction in raw material use : 10-20%
- Reduction in waste water generation : 10-30%
- Reduction in Air Emissions (GHG) : 5-10%
- Reduction in solid waste generation : 5-20%
- Yield improvement : 2-5%

## Central Pollution Control Board

### Introduction and objectives

The Central Pollution Control Board (CPCB) performs functions as laid down under the Water (Prevention & Control of Pollution) Act, 1974, and The Air (Prevention and Control of Pollution) Act, 1981. It is responsible for planning and executing comprehensive nationwide programmes for the prevention and control of water and air pollution, for advising the Central Government on matters concerning prevention and control of water and air pollution and for coordinating activities of State Pollution Control Boards / Pollution Control Committees besides providing technical assistance & guidance to them.



The Central Pollution Control Board has been playing a vital role in abatement and control of pollution in the country by generating environmental quality data, providing scientific information, rendering technical inputs for formulating national policies and programmes, training and development of manpower and organizing activities for promoting awareness at different levels of the Government and public at large.

The Central Pollution Control Board also co-ordinates enforcement and implementation of Rules framed under the Environmental (Protection) Act, 1986 with State Pollution Control Boards / Pollution Control Committees. It also provides support to various committees and authorities constituted by the Government of India such as The Environmental Pollution (Prevention and Control) Authority for the National Capital Region.

### Activities undertaken so far

- Coordinating activities of State Pollution Control Board for prevention and control of pollution;
- Development of industry specific national minimal effluent and emission standards;
- Development of industry specific environmental guidelines and comprehensive documents;
- Development of charter/requirements for Corporate Responsibility for Environmental Protection (CREP) for seventeen major polluting industrial sectors and monitoring its implementation through eight task forces and steering committees;
- Action plans for improvement of environment in eighty eight critically polluted areas and monitoring progress;
- Action plans for improvement of air quality in sixteen polluted cities and monitoring progress;
- National water quality monitoring and publishing annual water quality reports;
- National ambient air quality monitoring and publishing annual water quality reports;



- Carrying out and sponsoring research activities relevant to environment protection;
- Publishing material relevant to environment protection;

### Progress / achievements made during the year

#### Development of industry / waste specific standards and guidelines

**Petrochemical Industry :** CPCB undertook a study to develop national emission standard for petrochemical manufacturing units (basic and intermediate products), the proposed emission standards were finalized by Expert Committee on 27.02.2009.

**Petroleum Oil Refineries :** A proposal for revision of load based standards for Sulphur Recovery Units (SRU) in oil refineries has been forwarded to Ministry of Environment & Forests (MoEF) for notification.

**Sulphuric Acid Plant :** Revised emission standards have been have been linked to production capacities for existing & new units. They have been notified on May 07, 2008 vide G.S.R. 344(E) in Schedule-I under the Environment (Protection) Act, 1986.

**Sponge Iron Plants :** A document entitled 'Comprehensive Industry Document on Sponge Iron Plants' under COINDS series was published. The Standards were notified by Ministry of Environment & Forests vide Notification No. G.S.R. 414(E), dated the 30<sup>th</sup> May 2008 in the Gazette of India

**Thermal power plants :** A study for coal/lignite based thermal power plants was completed, it also includes the latest development in the field, pollution potential (particulate matter. SO<sub>2</sub> and NO<sub>x</sub> emissions)

and water pollution. Ash disposal and its utilization has also been assessed.

CPCB has conducted a study on development of guidelines and code of practice for control of fugitive emissions from coal and flyash storage and transfer points in thermal power plants. The study is an advance stage of completion.

**Reduction of Green House Gas Emission from Cement Plants :** The study on "Assessment of green house gas emission from cement plants" has been initiated in association with M/s C P Consultants Pvt. Ltd., New Delhi. The study will monitor the CO<sub>2</sub> emission from cement plants and will suggest various measures for reduction of green house gas emission.

Cement manufacturing industry sector is one of the major air polluting industry sectors in the country. There are about one hundred thirty cement plants in the country with the production capacity of one hundred ninety eight MTPA. A study on "Development of COINDS on cement plants" has been undertaken in association with National Council for Cement and Building Materials, Ballabgarh.

**Soda Ash Industries :** Soda Ash industries are located in the western coast in Gujarat. A study by National Institute of Oceanography (NIO), Goa to assess the effect of discharge of effluent from Soda Ash industries in the coastal area was undertaken. The findings of the Expert Committee are under finalization.

**Electric Arc & Induction Furnaces :** A study on 'Development of Environment Standards and Good Practices for Electric Arc Furnace (EAF) and Induction Furnace (IF)' has been

undertaken by CPCB, the report is under evaluation.

**Mercury Management in Fluorescent Lamp Sector** : CPCB has prepared guidelines for the study on Mercury Management in Fluorescent Lamp sector. An Inter-Ministerial Group has been formed by MoEF for effective mercury management and implementation.

**Pulp & Paper Industry** : Some selected pulp and paper mills were surveyed for the study on options for black liquor management of: Chemical Recovery System & Lignin Separation Technology.

Odour Control is a priority agenda for all the large integrated pulp & paper mills using kraft pulping process after inclusion in the Corporate Responsibility for Environment Protection (CREP).

**Electroplating Units** : Electroplating activities mostly operate in the small scale industry (SSI) sector. CPCB has constituted a National Task Force to study environmental issues of this sector.

**Cashew Seed Processing Industry** : A project has been undertaken to study the entire cashew nut processing industry sector in the country and suggest techno-economically feasible environmental standards.

**Plaster of Paris (PoP)** : A study on the above industry was undertaken, and the proposed standards for PoP have been approved by the Expert Committee of the MoEF.

**Stone Crushers** : Preparation of the above document has been completed. The emission standards & guidelines for pollution prevention from stone crushers have been

reviewed and revised and submitted to MoEF for notification.

**Dye and Dye Intermediate Industry** : Dyes and dye intermediates sector is vital in Indian chemical industry, as the sector accounts for more than half of the total export value of Indian chemical industry. Revision of effluent standards as well as development of emission standards for this sector has been taken up in association with National Chemical Laboratory, Pune

### Environmental Research Activities

**Testing and validation of BOD BIOSENSOR** : A study for testing and validation of BOD biosensor based on microbial mixed culture for rapid BOD determination in wastewater was undertaken. The BOD measurement takes considerable time i.e. three days at 27° C or 5 days at 20°C as well as consumes more energy. To overcome these constraints, attempts were made to carry out the test with in short period, through the technique using BIO-SENSOR probes. The CPCB has developed a BIO-SENSOR and instrument for rapid BOD test in collaboration with Institute of Genomics & Integrative Biology (IGIB), CSIR, Delhi.

**Pilot Plant Study using Sludge - Reagent-Product (SRP) technology** : An innovative technology on the above has been developed by CPCB for treatment of surface and GW. The study showed that eighty to ninety percent of chemical coagulant (alum), could be recovered from discarded alum-treated-sludge for recycling and reuse. Construction work for 0.5 MLD pilot Water treatment plant, based on SRP technology at Bhagirathi Water Works (Delhi Jal Board), Yamuna Vihar, Delhi is under progress.

**Elemental Analysis using ED-XRF Spectrophotometer :** Energy Dispersive X-Ray Fluorescence (ED-XRF) Spectrometer undertakes non-destructive elemental analysis in suspended particulate matter (SPM) fractions of PM<sub>10</sub> and PM<sub>25</sub> of ambient air. The instrument has been commissioned at CPCB, Delhi.

**Groundwater (GW) Remediation in Kanpur :** The pilot project on GW Remediation executed by CPCB's Zonal Office -Lucknow was reviewed by the Asian Development Bank

**Rain water profile at Agra city, Uttar Pradesh :** During the year, a series of rainwater samples (May to August 2008) were analyzed for pH, conductivity besides analyses of major cations (Ca, Mg, Na, Li, K, NH<sub>4</sub>) and anions (SO<sub>4</sub>, NO<sub>3</sub>, PO<sub>4</sub>, Br, F, Cl).

**Irrigation using treated effluent from paper mills :** A study on utilization of treated effluent from paper mills for crop irrigation and its impact on crop productivity and soil health was conducted by CPCB.

**Monitoring of Pesticide Residues - inter Ministerial Project :** The project on monitoring of pesticide residues at national level has been sponsored by the Department of Agriculture and Cooperation (DAC), Ministry of Agriculture, New Delhi and the All India Network Project (AINP) on Pesticide Residues, Indian Agricultural Research Institute New Delhi and CPCB. It is an inter-ministerial scheme involving Ministry of Agriculture, Ministry of Health, Ministry of Chemicals and Fertilizers, Ministry of Commerce, Ministry of Environment and Forest and State Agricultural Universities.

**Assessment of Phase Distribution of PCDDS & PCDFS in Ambient Air of Delhi :** The dioxin - furan congeners have been studied by numerous researchers to have a tendency to get distributed between particulate and vapor phase of the ambient air as well as stationary source emission. The National Reference Trace Organics Laboratory of CPCB has undertaken assessment of phase distribution of seventeen congeners (2,3,7,8 substituted congeners) between particulates and vapor phase by sampling of ambient air using PUF Samplers.

**Color Removal from Agro-based Pulp & Paper Mill Effluent - pilot study :** CPCB conducted a study on pilot scale for demonstration of electro-flocculation process for color removal from agro-based pulp & paper mill effluent. The process was found technically feasible to remove color from all types of colored effluents generated from the industry reduction of lignin, COD, BOD and toxicity in terms of AOX and total solids.

**Determination of Volatile Organic Compounds (VOCS) by Purge and Trap Pre-Concentration Followed by Gas Chromatograph - Mass Spectrophotometer Analysis :** VOCs are organic compounds that readily evaporate at normal air temperature. Fuel oils, gasoline, industrial solvents, paints, and dyes are the major sources of VOCs. The National Reference Trace Organics Laboratory (NRTOL) of CPCB has initiated the Standardization of methodology and assessment of levels of Volatile Organic Compounds (VOCs) in surface water, drinking water and ground water by purge & trap sample pre-concentration followed by GC-MS analysis.

**Trihalomethanes (THMS) In Drinking Water Sources in Bangalore (Karnataka) :** The raw potable water for at Bangalore is obtained from Arkavathi and Cauvery rivers. After treatment / disinfection the treated water is supplied to distribution points viz. TG Halli, TK Halli, Tavanakere and Tataguni. Potable water samples were collected at the outlets of these distribution points for further analysis, whether Di-chlorobromomethane were present in the samples.

**Human Health Risk Assessment Studies in Asbestos based industries :** Various products like asbestos-cement sheets, asbestos-cement pipes, brake lining, asbestos ropes require asbestos as raw material. The CPCB has prepared a document on "Human Health Risk Assessment Studies in Asbestos based Industries in India" in collaboration with the Indian Institute of Toxicology Research, Lucknow. The report provides detailed information on human risk of asbestos exposure and its health effects.

### Laboratories Development



**Evaluation and Recognition of Environmental laboratories under the Environment (Protection) Act, 1986 :** Central Pollution Control Board in association with Ministry of Environment & Forests had developed Guidelines for Evaluation & Recognition of Environmental Laboratories under Laboratory Analytical Technical Series: LATS/9/2005-2006, this document is posted both in the websites of CPCB and MoEF websites (cpcb.nic.in / envfor.nic.in).

**Strengthening of State Pollution Control Boards' (SPCBs) Laboratories :** The proposals received from various State Pollution Control

Boards through Ministry of Environment & Forests for financial assistance for strengthening of laboratories have been reviewed and suggestions provided to make the proposals comprehensive to facilitate funding.

**Analytical Quality Control (AQC) for Central and State Pollution Control Boards (SPCBs) laboratories recognized under the E.P. Act 1986 :** The CPCB is monitoring a large network of water quality monitoring stations under GEMS, MINARS, GAP and YAP Programmes comprising rivers, lakes, wells, and ground waters spread over twenty seven states and six Union Territories through various SPCB . In order to obtain reliable and accurate analytical data, CPCB is regularly conducting organized Analytical Quality Control (AQC) exercise for laboratories of SPCBs / PCCs, recognized under The Environment (Protection) Act, 1986.

**Laboratory Activities at CPCB's Zonal Offices (ZOs) :** Zonal Office (Z.O.) laboratory at Bangalore, Kolkata, Vadodara have highly sophisticated instruments for analysis of various environmental parameters. Strengthening of the other ZOs laboratories is underway.

**Participation of CPCB Laboratories in International Proficiency Testing (PT) Programme conducted by New York State Department of Health, USA**

In order to ensure analytical quality, the CPCB laboratories at HQs, Zonal Offices at Kolkata and Lucknow participated in Proficiency Testing Programme organized by New York State Dept. of Health, Wadsworth Centre, Environmental Laboratory Approval

Programme, Albany New York for Proficiency Test of samples related with potable water chemistry, non potable water chemistry, solid and hazardous waste, potable and non potable water bacteriology.

### **National Water Quality Monitoring Programme (NWMP)**

The CPCB established a network of water quality monitoring stations across the country, the water quality monitoring network is being operated under a three-tier programme viz.

- Global Environmental Monitoring System (GEMS);
- Monitoring of Indian National Aquatic Resources System (MINARS) and
- Yamuna Action Plan (YAP).

Presently the network comprises of one thousand two hundred forty five stations spread over the country in twenty seven States and six Union Territories. Most of the sampling is done on either on a monthly or quarterly basis for surface waters bodies and on half yearly basis for ground water quality. Out of one thousand two hundred forty five stations six hundred ninety five are on rivers, eighty six on lakes, nineteen on drains, nineteen on canals, six tanks, twelve on creeks/seawater, twenty six ponds and three hundred eighty two are groundwater stations. Water quality of two hundred ninety three rivers in major, medium and minor basins is observed in the country.

Water samples are analyzed for twenty eight physico-chemical and bacteriological parameters besides, nine trace metals and twenty eight pesticides are also analyzed for

some selected samples. Some major cations, anions and micro pollutants (toxic metals & POP's) are also being analyzed once a year to keep a assess water quality over large period of time. The water quality data are reported as CPCB publications as Water Quality Status Year Book and is also displayed in CPCB's website.

Bio-monitoring is also carried out in specific locations.

### **Water Quality of River Ganga**

Water quality monitoring of the river Ganga and its tributaries is carried out in the State (s) of Uttaranchal, Uttar Pradesh, Bihar and West Bengal at thirty nine locations by CPCB's North Zonal Office - Lucknow.

### **Water Quality Status of River Yamuna**

The entire stretch of river Yamuna (1376 km) is being regularly monitored by CPCB on an yearly frequency at twenty locations, quarterly frequency at three locations, while on a monthly frequency at other locations. The water quality trend of the river during the last five years (2004-2008) in terms of Dissolved Oxygen (DO) Bio chemical Oxygen demand (BOD), Total Coliform (TC) and Faecal Coliform (FC) has been analyzed.

### **Water Quality Trend**

The water quality monitoring data has been analyzed for biochemical oxygen demand (BOD) an indicator of organic matter and for total coliform and faecal coliform which are indicators of pathogenic bacteria. The water quality monitoring data obtained from various monitoring stations between years 1995 to 2008 indicated that organic and bacterial contamination continue to be

critical in water bodies, particularly BOD was observed to be very high at some locations on major rivers / canals.

### Water Quality of River Gomti

Gomti River, a tributary of the river Ganga contributes to about 15 % flow of Ganga. The average dry weather flow of this river is reported to be 1500 MLD, which become as high as 55000 MLD during monsoon season and as low as 500 MLD during the summer. Water quality of River Gomti was monitored in 2008 from Sitapur upto confluence with river Ganga.

### National Air Quality Monitoring

#### National Air Quality Monitoring Programme (NAMP)

Central Pollution Control Board conducts ambient air quality monitoring under the nation-wide National Air Quality Monitoring Programme (NAMP) comprising of three hundred sixty five stations covering one hundred forty one cities / towns in twenty six States and five Union Territories. Under NAMP, four criteria air pollutants have been taken up for monitoring at all the locations:

- Sulphur Dioxide ( $SO_2$ ),
- Nitrogen Dioxide ( $NO_2$ ),
- Suspended Particulate Matter (SPM) and
- Respirable Suspended Particulate Matter (RSPM /  $PM_{10}$ )



The monitoring under the NAMP is being carried by Central Pollution Control Board through its Zonal Offices, State Pollution Control Boards and Pollution Control Committees and National Environmental Engineering Research Institute (NEERI), Nagpur.

A study on the assessment of levels of polychlorinated dibenzo-p-dioxins (PCDDS) and polychlorinated dibenzofurans (PCDFS) in RSPM of ambient air at Delhi was carried out. The CPCB regularly monitors Respirable Suspended Particulate Matter (RSPM) in ambient air of Delhi and at several locations under the National Ambient Air Quality Monitoring Programme (NAMP). From January 2008 the assessment of levels of dioxins (PCDDs) and furans (PCDFs) in particulate phase of ambient air have been undertaken by analysis of RSPM collected on glass fibre filter papers from various NAMP locations.

### Emission Inventory and Source Apportionment Studies for Indian Cities

Under the project 'Air Quality Assessment, Emission Inventory And Source Apportionment Studies For Indian Cities ' studies on development of emission factors for vehicles, and source emission profiles for vehicular as well as non-vehicular sources have been concluded. Source apportionment studies have been carried out at six major cities viz. Delhi (NEERI), Mumbai (NEERI), Chennai (IITM), Bangalore (TERI), Pune (ARAI) and Kanpur (IITK) for assessing contribution of different source categories in the ambient air quality and subsequent preparation of Air Quality Management Plan. The reports comprise air quality monitoring results for three seasons.

### Revision of Ambient Air Quality Criteria / Standards

CPCB had taken up revision of existing National Ambient Air Quality Criteria/ Standards in association with the Indian

Institute of Technology, Kanpur (IITK). The draft revised standards have been finalized in the 22nd meeting of the Peer & Core Committee, held in CPCB.

### Ambient Air Quality Trend at Tajmahal, Agra

CPCB has been regularly monitoring ambient air quality at Agra at four locations since year 2002. Ambient air quality data of Agra is also being submitted to Hon'ble Supreme Court of India under Writ Petition (C) No. 13381/1984 M.C. Mehta Vs Union of India.

### Ambient Air Quality under Male Declaration

A ambient air quality station under the project 'Ambient Air Quality Monitoring At Port Canning, West Bengal Bordering Bangladesh Under Male Declaration' at Port Canning, West Bengal is operational since September, 2004 which also has one meteorological station. CPCB is regularly monitoring RSPM, NO<sub>2</sub> and SO<sub>2</sub> for at least ten days in a month. Analysis of the rainwater is also being regularly undertaken here.

### Atmospheric Mixing Depth (SODAR) Observations at Delhi

Sound Detection and Ranging System (SODAR) is in continuous operation at CPCB which measures the mixing height. The SODAR data collected in different months during 2008-09 has been analysed.

### Mass emissions in vehicular pollution control

Automobile Pollution Control initiatives included enforcement of a variety of control measures ranging from

notification of advanced Euro-IV equivalent emission norms and commensurate fuel for new vehicles to stricter exhaust emission limits for in-use vehicles, augmentation of infrastructures for alternative fuels, mass transits and other urban planning and management options. The implementation of the road map as recommended by the Auto Fuel Policy of India has been continued for implementation. The Motor Vehicle Act, 1988, and the Central Motor Vehicles Rules (CMVR), 1989, are the principal instruments for regulation of motor vehicular traffic / emissions throughout the country. The salient control measures pertain to:

- Mass Emission Standards
- Fuel Quality Specifications

### Sewage Treatment

#### Status of water supply, sewage (collection, treatment and disposal) in Class-I Cities and Class-II Towns

CPCB has initiated a survey on status of water supply, sewage collection/treatment/disposal and municipal solid waste (MSW) collection / processing /disposal in Class-I Cities and Class-II Towns.

#### Survey and monitoring major drains in National Capital Territory (NCT) Delhi

Twenty one major wastewater drains (outfalls) of NCT- Delhi are being monitored regularly by CPCB . on a monthly basis. Out of twenty one drains, seventeen drains join river Yamuna, three join the Agra Canal and one drain joins the Gurgaon canal. Najafgarh drain is the biggest drain followed by Shahdara drain. These two drains together contribute about 58% and 75% of total BOD

load and total discharge of all the monitored drains.

### Performance of Sewage Treatment Plants (STPs)

- In Gujarat, there are twelve sewage treatment plants located in Vadodara (three), Surat (six), Ahmedabad (two), Rajkot (one). In Maharashtra, there are twenty three STPs located in various cities. CPCB's Zonal Office - Vadodara has monitored nine STPs in Gujarat and two STPs in Maharashtra in 2008 - 09.
- The following STPs were monitored by CPBC's Zonal Office Bhopal in Rajasthan and M.P:
  - STP Jalmahal Road, Jaipur (October 20-21, 2008)
  - STP Delawas, Jaipur (October 20-21, 2008)
  - STP Kabitkhedi, Indore (March, 2009)

### Performance of Sewage Treatment Plants (STPs) in U.P., Haryana and Delhi under Yamuna Action Plan



CPCB regularly monitors four sewage treatment plants constructed under Yamuna Action Plan (three STPs in Haryana State & one STP in Delhi) for their performance evaluation under National River Conservation Directorate project.

### Municipal Solid Waste

#### Status of Municipal Solid Waste (MSW) Management

CPCB carried surveys for thirty five metro cities and twenty four state capitals. Waste segregation was not being done at the source and this is a major handicap in

MSW management. The estimated state-wise MSW (generation and collection) in 2008 is given in Table-19.

Some of the technologies available for MSW treatment are:

- Composting
- Vermin-composting
- Refused Derived Fuel (RDF) for utilizing in power generation
- Bio-methanation
- Landfill as a bio-reactor

The states of Gujarat, West Bengal, Goa, Andhra Pradesh, Karnataka, Maharashtra have made satisfactory progress in management of MSW.

### Plastic Waste

#### Evaluation of Biodegradable Plastics

A field survey cum study on "Establishment and Impact of Biodegradable Plastics on Environment / Food" was conducted by CPCB in association with Central Institute of Plastics Engineering & Technology (CIPET) Chennai. In the study, more than ten units were visited by the study team and samples such as poly bags, master batches/additives were collected from various hotels, restaurants, hospitals in and around Delhi and analysed.

#### Co-processing of Plastic Wastes as fuel supplement in Cement Kiln

Keeping in view the problems associated with the disposal of plastic waste, CPCB initiated a study on "Co-processing of plastic waste as supplement fuel in cement kilns" in collaboration with the Indian Centre



Table-19. State-wise MSW generation and collection

Sl. No.	States/UTs	Total Towns	% Waste Collection Efficiency	MSW Generation (TPD)
1	Chandigarh	1	75	1389159
2	Gujarat	242	75	24588124
3	Maharashtra	378	70	55052207
5	West Bengal	375	70	27445574
6	Meahalaya	16	68	525243
7	Andhra Pradesh	210	65	25353613
8	Delhi	62	65	22526265
10	Punjab	157	65	10504627
12	Haryana	106	62	7530141
13	Madhya Pradesh	394	62	19347071
14	Uttar Pradesh	704	62	40281443
15	Himachal Pradesh	57	60	642275
16	Karnataka	270	60	22845629
17	Kerala	159	60	9983801
18	Rajasthan	222	60	15687050
19	Tamil Nadu	832	60	37167161
21	Pudducherry	6	56	994048
22	Assam	125	55	3794170
28	Orissa	138	55	6178866
31	Bihar	130	50	9408294

for Plastics in the Environment, Madhya Pradesh Pollution Control Board at the ACC Ltd., Kymore Cement Works, Madhya Pradesh.

#### Performance Study of Polymer Coated Roads

CPCB in association with Thiagarajan College of Engineering, Tamil Nadu undertook a study on performance polymer coated roads i.e. use plastic wastes in laying roads.

#### Biomedical Waste Management

##### Status of Bio-medical Waste Management

Based on the data forwarded by the SPCBs/ PCCs CPCB summarized the status of BMW management. The salient features gathered in

2008 - 09 are as follows (excludes Arunachal Pradesh and Lakshadweep):

- i) Total No. of healthcare facilities : 97,662
- ii) Total No. of beds : 12,57,695
- iii) No. of Common Bio-medical Waste Treatment Facilities (CBWTF) : 170
- iv) Total No. of healthcare facilities using CBWTF : 49,971
- v) Total No. of healthcare facilities applied for authorization : 47,750

The establishment Common Bio-medical Waste Treatment Facilities (CBWTF)

have been on the rise, from one hundred fifty seven in the year 2006-2007 to one hundred sixty five in the year 2007-2008 and to one hundred seventy in the year 2008-2009.

### Action Plan for implementation of BMW (Mgmt. & Handling) Rules, 1998

In the "Interaction meet" held at New Delhi on August 08, 2008 a draft action plan was prepared and circulated to all the stakeholders SPCBs / PCCs / IMA / CBWTF operators etc seeking their suggestions, the final draft Action Plan was finalized and communicated to the MoEF for approval.

### Hazardous Waste Management

#### Treatment, Storage and Disposal Facilities (TSDFs)

Common Treatment, Storage and Disposal Facilities (TSDFs) have been developed for the disposal of land disposable Hazardous Waste (HW) at twenty two different places in ten States namely, Gujarat (seven Nos.), Maharashtra (four Nos.), Uttar Pradesh (three Nos.), Andhra Pradesh (two Nos.), Himachal Pradesh (one No.), Madhya Pradesh (one No.), Punjab (one No.), Rajasthan (one No.), Tamil Nadu (one No.), and West Bengal (one No.). Total waste handling capacities (disposal capacity) of these facilities, is 15,00,568 MTA which is much less than the present generation of 27,28,326 MTA of land-disposable Hazardous Wastes.

The details of Hazardous Wastes Management facilities available in India are given below:

- Common Incinerators
  - Thirteen Nos. in six States

- Individual Incinerators
  - One hundred twenty seven Nos. in twelve States
- Total incineration capacity
  - 3,27,705 MTA
- Present generation
  - 4,15,794 MTA Incinerable waste in the country

### National Inventory of Hazardous Wastes Generating Industries

Based on information provided by twenty seven SPCBs and three PCCs pertaining to the period 2007-08, the report on 'National Inventory of Hazardous Wastes Generating Industries' has been prepared and posted on Central Pollution Control Board website.

The HW management at a glance:

- Land Fillable Hazardous Wastes - 49.55%
- Incinerable Hazardous Wastes - 6.67%
- Recyclable Hazardous Wastes - 43.78%

### Performance of Captive Secured Landfill Sites (SLFs) in Central Zone

Many industrial units have been permitted to develop captive SLFs within their own premises to dispose the hazardous wastes generated in the processes. Most of the recyclers/re-processors of non-ferrous metal wastes such as lead, zinc etc. and waste/used oil were also permitted to have captive SLFs in their premises.

### Co-incineration of High Calorific Value Hazardous Wastes in Cement Kiln

CPCB had conducted trial runs for co-incineration of high calorific value hazardous wastes in cement kilns, as fuel supplement for

which, the Ministry of Environment and Forests has provided concurrence. The studies are being complied for finalization.

### Societal Risk Cost for Common Hazardous Waste Incinerator

CPCB in association with M/s UPL Environmental Engineers Ltd has initiated a study on 'Computation of Societal Risk Abatement Cost and Long Run Marginal Financial Cost of Common Hazardous Waste Incinerator'. The objective of the study is to find out what the user will need to pay for reaching out to the range of alternative levels of emissions of total dioxins and furans.

## Hazardous Substances Management (HSM)

### Introduction and Objective

The mandate of the Hazardous Substances Management (HSM) Division is to promote safety in the management and use of hazardous substances including hazardous chemicals and hazardous wastes with the objective of preventing and mitigating damage to health and environment. Major functions of HSMD include regulatory activities relating to hazardous chemicals and hazardous wastes, and planning, overseeing and implementing policies and programmes for management of chemical emergencies and hazardous substances.

### Progress of activities under different programmes

#### Hazardous Waste Management

Hazardous waste, bulk of which is generated by the industries, can cause environmental pollution and adverse health effects if not handled and managed properly.

Its effective management, with emphasis on minimization of its generation and recycling/reuse taking into account economic aspects, is therefore essential. Various actions have been taken to manage hazardous wastes in the country, which include establishing a regulatory and institutional framework, preparation of technical guidelines, development of individual & common facilities for recycle/recovery/reuse, treatment and disposal of hazardous wastes, preparation of an inventory of hazardous wastes generation, identification & assessment of hazardous waste dump sites for the purpose of preparing remediation plans and creating awareness amongst various stakeholders.

To regulate management of hazardous waste generated within the country as well as export/import of such wastes, the Hazardous Wastes (Management and Handling) Rules, 1989 were notified under the Environment (Protection) Act, 1986. New rules titled Hazardous Wastes (Management, Handling and Transboundary Movement) Rules, 2008 have been notified superseding the earlier regulation. Recycling of e-waste and the requirement of registration for e-waste recyclers have been included under these Rules. A national strategy on hazardous wastes is being prepared to facilitate implementation of an action plan for management of hazardous waste, and to fulfill obligations under the Basel Convention on transboundary movement of hazardous waste, including their minimization, environmentally sound management and active promotion of cleaner technologies.

The Ministry has sponsored a National Hazardous Waste Inventorisation project for tracking the waste from its generation to its

disposal point. An inter-ministerial coordination committee has been constituted to co-ordinate at the field level for effective implementation of the HW Rules.

During the year, financial assistance of 3.2 crores has been provided to the States of Maharashtra and Uttar Pradesh for establishment of TSDFs.

### **Chemical Safety**

The Manufacture, Storage and Import of Hazardous Chemical (MSIHC) Rules, 1989 and the Chemical Accident (Emergency Planning, Preparedness and Response) Rules, 1996 are the main instruments for ensuring chemical safety in the country. There are one thousand eight hundred forty one MAH units in the country, located in two hundred ninety two districts in twenty six States/UTs (twenty three States & three UT's) of the country.

A sub-scheme entitled "Industrial Pocket-wise Hazard Analysis" has been in operation since the Eight Five Year Plan. Out of two hundred ninety two districts having Major Accident Hazard (MAH) units, hazard analysis studies have been initiated for one hundred ten districts. Out of these, ninety six studies have been completed. During the current financial year thirteen hazard analysis and off-site studies have been initiated.

Financial assistance for conducting training programmes on Emergency Preparedness, Accident Prevention has been provided to National Safety Councils, Associated Chambers of Commerce and Industry, Federation of Indian Chamber of Commerce Industry (FICCI) and other state run institutions. The main objective of the programme is to effectively prepare, prevent and mitigate emergencies arising due to

chemicals and to impress upon the people concerned the necessity of emergency preparedness and response.

A Red Book containing duties to be performed during emergency, names, addresses and telephone numbers of key functionaries of State Governments, State Pollution Control Boards, Chief Inspectorate of Factories, Experts/Institutions is being updated.

Under the Indo-Canada Environment Management initiative, a project has been initiated for developing the National Chemicals Management Profile for India. The main objective of the project is to assess India's national infrastructure for managing chemicals, as an important first step to strengthen national capacities and capabilities for sound management of chemicals. The Central Pollution Control Board was entrusted with the responsibility of implementing the project.

The Ministry continues to take follow-up steps for improving implementation of the Manufacture, Storage and Import of Hazardous Chemical (MSIHC) Rules 1989 and the Chemical Accident (Emergency Planning, Preparedness and Response) Rules, 1996.

A "GIS based Emergency Planning and Response System" for chemical accidents in Major Accident Hazard (MAH) units has been developed. In selected districts of Gujarat and Maharashtra, steps have been taken to make the GEPR tool more functional, comprehensive and user friendly for emergency planner and responders. The additional features being incorporated include- upgradation of non-spatial data by the authorities, high resolution mapping to

enhance the quality of spatial features, enhanced modeling features, online modeling, cascading or domino effects, etc.

A Web Based Online Chemical Accident Information and Reporting System (CIARS) has been initiated by the Ministry to develop an online accident reporting and analysis mechanism where authorities can log in and enter accident related information online and the data can be sorted, analyzed and reviewed, as per requirement. The software for this has been developed and a link has been provided to the Home Page of the Ministry's website.

Financial assistance has been provided for establishment of three Emergency Response Centres one each at Kakinada, Vijayawada and Kurnool districts of Andhra Pradesh.

The Ministry has initiated the process of developing a reference handbook with Do's and Don'ts of Highly Toxic and Flammable Chemicals. The project aims to identify about one hundred chemicals, from severity, usage and transportation angles, which require prime attention by first responders. The project has been assigned to the National Safety Council, Kerala Chapter. The report is expected soon.

The Ministry has initiated the process for development of National Implementation Plan (NIP) under the Stockholm Convention. The activities relating to development of NIP have been assigned to premier scientific and research institutions.

### **Management of Municipal Solid Wastes**

An Expert Committee to evolve a roadmap for proper management of wastes

in the country has been constituted. The report of the Committee has been finalized and shall be published shortly. The report addresses various categories of wastes and regulatory, institutional and infrastructural issues.

Financial assistance has been provided for setting up facilities for management of Municipal Solid Wastes in twelve cities/towns under the Ahmedabad Urban Development Authority (AUDA), Gujarat.

Training programmes are being conducted for various stakeholders on management of Municipal Solid Wastes (MSW).

### **Management of Plastic Wastes**

Plastics are used world over. These are littered around and if not collected systematically may find their way into the drainage system resulting in choking of drains, creating unhygienic environment and causing health problems. The Ministry has notified the Recycled Plastics Manufacture and Usage Rules, 1999 under the Environment (Protection) Act, 1986 and amended them in 2003 for regulating and managing plastic carry bags and containers.

After extensive consultations with stakeholders, the Ministry has now notified the draft Plastics (Manufacture, Usage & Waste Management) Rules, 2009 and invited objections/ suggestions to the proposals contained in the draft notification to finalize the notification. The new Rules will supersede the existing Recycled Plastics Manufacture and Usage Rules, 1999 (as amended in 2003).

Training programmes are being conducted for various stakeholders on Management of Plastic Wastes.

### Management of Chemicals

The 2<sup>nd</sup> International Conference on Chemicals Management (ICCM-2) under the Strategic Approach to International Chemicals Management (SAICM) was held from 11-15 May 2009 in Geneva. This was the first substantive meeting of the ICCM, providing an opportunity to take stock of early phases of SAICM's implementation and focus on management issues to make the ICCM operational in the long-term so that by the year 2020, chemicals are used and produced in a way that protects human health and the environment throughout their life cycle. The ICCM-2 decided to address, inter-alia, new and emerging issues viz. lead in paint, nanotechnology and nanomaterials, chemicals in products, electronic waste etc.

An award ceremony was held to recognize the contributions made by different stakeholders in implementation of SAICM and the ICCM-2. The Silver Award was given to India. An Indian delegation led by Shri R. H. Khwaja, Special Secretary, Ministry of Environment and Forests participated in the conference.

A broad consensus on a Legal Binding Instrument (LBI) for mercury was reached in the 25<sup>th</sup> UNEP Governing Council meeting held at Nairobi in February 2009.

### Bio-Medical Waste Management

The Ministry has notified the Bio-Medical Waste (Management & Handling) Rules, 1998 (BMW Rules) under the provisions

of Environment (Protection) Act, 1986 for proper management and handling of Bio-Medical Waste (BMW) generated in the country. Under these Rules, the wastes generated by Health Care Establishments (HCEs) have been categorized into 10 categories and treatment & disposal methods for each of these categories of wastes have been specified. The status of implementation of these rules is being regularly monitored by the respective State Pollution Control Boards (SPCBs) and Pollution Control Committees (PCCs) of Union Territories.

The main difficulties faced by the agencies concerned in proper and effective implementation of BMW Rules are lack of awareness about the rules and lack of proper training of the medical and para-medical personnel involved in the Health Care Establishments. The Ministry and CPCB provide funds for organizing training workshops to the stakeholders. Lack of adequate common bio-medical waste treatment and disposal facilities in the country is also a major issue. The Ministry has initiated a scheme to provide Central subsidy for setting up such facilities.

Awareness and training workshops for stakeholders on Bio-Medical Waste Management for effective implementation of Bio-Medical Waste (Management & Handling) Rules were conducted in Tamil Nadu, Manipur, Karnataka and Andhra Pradesh, with the involvement of the respective State Pollution Control Boards.

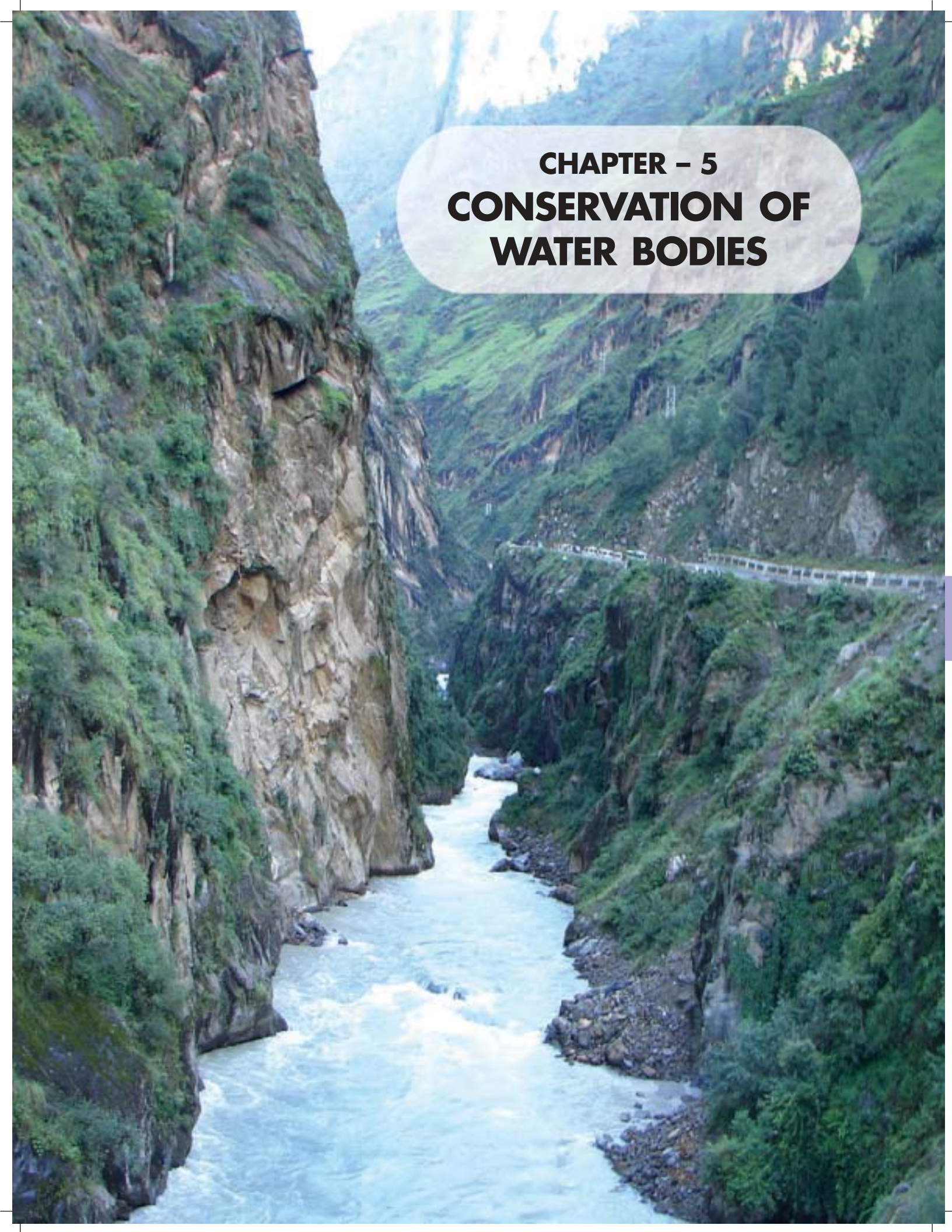

**CHAPTER – 5**  
**CONSERVATION OF**  
**WATER BODIES**

## National River Conservation Directorate

The National River Conservation Directorate (NRCD), functioning under the Ministry of Environment and Forests is engaged in implementing the River and Lake Action Plans under the National River Conservation Plan (NRCP) and National Lake Conservation Plan (NLCP) by providing financial assistance to the State Governments.

## National River Conservation Plan (NRCP)

### Introduction and Objectives

The objective of National River Conservation Plan (NRCP) is to improve the water quality of the rivers, which are the major water sources in the country, through the implementation of pollution abatement works, to the level of designated best use. So far a total of thirty eight rivers have been covered under the programme. The rivers are given in Table-20.

The pollution abatement works taken up so far under the NRCP include:

- Interception and diversion works to capture the raw sewage flowing into the river through open drains and divert them for treatment.
- Setting up Sewage Treatment Plants for treating the diverted sewage.
- Construction of Low Cost Sanitation toilets to prevent open defecation on river banks.
- Construction of Electric Crematoria and Improved Wood Crematoria to conserve the use of wood.
- River Front Development works such as improvement of bathing ghats.
- Afforestation on the river banks, Public Participation & Awareness etc.

## National Ganga River Basin Authority

The Central Government has given Ganga the status of a 'National River' and has constituted a 'National Ganga River Basin

Table-20. River covered under NRCP

S. No	River	S. No	River	S. No	River	S. No.	River
1	Adyar	11	Ganga	21	Musi	31	Tapi
2	Betwa	12	Godavari	22	Narmada	32	Tunga
3	Beehar	13	Gomati	23	Pennar	33	Tungabadra
4	Bhadra	14	Khan	24	Pamba	34	Tamrabarani
5.	Brahmani	15	Krishna	25	Panchganga	35	Vaigai
6	Cauvery	16	Kshipra	26	Rani Chu	36	Vennar
7	Cooum	17	Mahanadi	27	Sabarmati	37	Wainganga
8	Chambal	18	Mandovi	28	Satluj	38	Yamuna
9	Damodar	19	Mandakini	29	Subarnarekha		
10	Dhipu & Dhansiri	20	Mahananda	30	Tapti		





Fig-28. A view of river Ganga

Authority' (NGRBA) on February 20, 2009. The NGRBA has been set up as an empowered planning, financing, monitoring and coordinating authority for the conservation of Ganga River with a holistic approach under the Environment (Protection) Act, 1986.

The Authority is chaired by the Prime Minister and has as its members, the Chief Ministers of the States through which Ganga flows, viz., Uttarakhand, Uttar Pradesh, Bihar, Jharkhand and West Bengal. The Union Ministers of Environment & Forests, Finance, Urban Development, Water Resources, Power, Science & Technology, Deputy Chairman,

Planning Commission are also the members of the Authority. Upto ten experts in the fields of environmental engineering, hydrology, river conservation, social mobilization, etc can be co-opted as members. The Secretary, Ministry of Environment & Forests is the Member Secretary of the Authority. The Ministry of Environment & Forests is the nodal Ministry for the Authority and would provide the administrative and technical support. The Authority has both regulatory and developmental functions. The Authority will take measures for effective abatement of pollution and conservation of the river Ganga in keeping with sustainable development needs.

The Notification also provides for constitution of a State River Conservation Authorities by the State Governments concerned to be set up under the chairmanship of the Chief Minister, for coordinating and implementing the river conservation activities at the State level.

This model could be adapted for other rivers in the country, based on the experience gained. Besides setting up of the NGRBA, it is proposed to strengthen the ongoing National River Conservation Programme (NRCP) for tackling polluted stretches for other major rivers in the country. The river basin approach for planning, the attention to adequate flows in the river and improved institutional and implementation mechanism as discussed in the succeeding paragraphs are being adopted for the National River Conservation Programme by the Central and State Governments.

### First meeting of the NGRBA



The first meeting of the NGRBA was held on 5<sup>th</sup> October, 2009 under the Chairmanship of the Prime Minister. The meeting was attended by the Chief Ministers of Uttarakhand and Bihar, Union Ministers of Urban Development, Water Resources and the Union Minister for Environment and Forests, besides the Deputy Chairman Planning Commission.

### Major Decisions in the meeting

– Approval for Mission Clean Ganga— No untreated municipal sewage and industrial effluent to enter Ganga by 2020

The Authority decided that under Mission Clean Ganga it will be ensured that by

2020 no untreated municipal sewage and industrial effluents flow into Ganga. Currently there is a sewage treatment capacity of only about 1000 mld against 3000 mld sewage being generated in the towns along Ganga. An estimated investment of Rs 15,000 crores over next ten years will be required to create the necessary treatment and sewerage infrastructure. It was agreed that the required resources will be provided by Centre and States over ten-year period to be shared suitably between Centre and states after Planning Commission consultations. New and innovative models for implementation like, for instance, special purpose vehicles to be adopted.

- **Pollution hotspots** : While preparation of comprehensive river basin management plan will take time, on-going sewage treatment projects will be put on fast-track. States will formulate DPRs for new projects in critical pollution hotspots and major towns on Ganga and major tributaries.
- **Memorandum of Agreements (MoA)**: Tripartite MOAs will be signed with the State Governments/Urban Local Bodies/Implementing Agencies for implementation as well as Operation & Maintenance of the pollution abatement projects and the initial portfolio of projects will be sanctioned by the end of the current financial year.
- **Action Plan for industrial pollution** : Union Ministry of Environment and Forests will work with states to prepare specific action plans for dealing with problem of industrial pollution in Ganga Basin.

Action initiated so far

The following actions have been taken since the setting up of the Authority:

- Expression of Interests (EOIs) were invited for preparing a comprehensive Ganga river basin management plan. RFPs have been issued to ten shortlisted firms. Rs 250 crore have been allocated in the Union Budget for 2009-10 for NGRBA.
- Discussions have been initiated with the World Bank for long term support of Authority's work programme.
- Empowered State River Conservation Authorities have been notified for West Bengal, Jharkhand and Uttar Pradesh.
- Action has been initiated for third party

evaluation of schemes. Independent institutions will be appointed for this purpose soon.

- A Status paper on Ganga has been prepared by Alternate Hydro Energy Centre, Indian Institute of Technology (IIT), Roorkee providing an overview of Ganga Basin.
- Indian Institute of Technology (IIT), Kanpur has prepared a compendium of different technological options available for treatment of sewage. The compendium is a collation of information gathered from the Central and State Government agencies, various organisations and experts and provides an assessment of the performance of different technologies.



Fig-29. River front development at Kolkata

- The National Informatics Centre (NIC) has been entrusted with the work of GIS based mapping of the entire Ganga Basin. The work has commenced and is expected to be completed by mid-2010.
- Action has been initiated for enhancing public awareness and community mobilisation for cleaning of rivers. States have been requested to prepare detailed city level Action Plans for the purpose which can be implemented through City Level Committees, to be constituted under the chairmanship of District Magistrates in major towns along the river Ganga. The District Coordinator of NYKS could be the Member Secretary of the Committee. Other members of the Committee may include prominent NGOs, public representatives, officials of concerned departments like the Municipal Commissioner, Pollution Control Board, Public Health Department, Forest Department, nodal implementing agency in the state for river conservation works, etc. The Action Plans prepared by these Committees in the Ganga States would be supported and funded under the NGRBA.

### Activities/Progress under NRCP



The present sanctioned cost of NRCP projects is Rs.4691.54 crore covering one hundred sixty seven towns along polluted stretches of thirty eight rivers spread over twenty States (Annexure-V). Some of the important River Action Plans are detailed below.

### Ganga Action Plan (GAP)

The Ganga Action Plan initiated in 1985 is the first River Action Plan. Besides other pollution abatement works, a sewage

treatment capacity of 869 mld. (million litres per day) was created under Phase-I and an amount of about Rs. 452 crore was spent under the Plan. This phase was declared completed in March 2000. Since GAP Phase-I did not cover the pollution load of Ganga fully, GAP Phase-II was taken up which included, Ganga and its four tributaries i.e. Damodar, Gomti, Mahananda and Yamuna. Works under Ganga Action Plan Phase-II covers sixty towns along the main stem of river Ganga at an Sanctioned cost of Rs. 635.66 crore.

### Yamuna Action Plan (YAP)

Under Yamuna Action Plan Phase-I, assisted by the Japan Bank for International Cooperation (JBIC), a total of 753 mld. sewage treatment capacity was created and this Phase was declared completed in March, 2003.

A loan assistance of Yen 13.33 billion has been extended by the Japan International Cooperation Agency (JICA) which has been merged with JBIC for implementation of Yamuna Action Plan (YAP) Phase II, which is part of the National River Conservation Plan (NRCP).

The project has been approved at an estimated cost of Rs. 624 crore for abatement of pollution of river Yamuna in Delhi, Uttar Pradesh (eight towns) and Haryana (six towns) under YAP-II. The cost of works is to be shared between Government of India and the State Governments in the ratio of 85:15. A sewage treatment capacity of 189 mld is targeted to be created besides major rehabilitation/replacement works for sewers and other pollution abatement works. So far thirty one

pollution abatement schemes have been sanctioned at a cost of Rs.647.86 crore, out of which seven schemes have been completed and others are in different stages of progress.

The main components to be implemented under the project are:

- Delhi — STP (135 mld capacity new and 324 mld capacity rehabilitation)  
Rehabilitation/replacement of trunk sewers (30.82 kms)
- UP — STP (54 mld capacity new)  
Sewer lines (70.57 kms)  
Rising Main (5.25 kms)
- Haryana — Sewer lines (73 kms).

Emphasis has also been given on public participation, capacity building etc. in order to ensure better utilisation of assets and long term sustainability of the project. Implementation of various works is underway in the States.



Fig-30. Awareness creation for conservation of river Yamuna

## Gomti Action Plan (GoAP)

### Gomti Action Plan (GoAP) Phase-I

The total approved cost of Gomti Action Plan-I is Rs. 64.01 crore for taking up river pollution abatement works in the towns of Lucknow, Sultanpur and Jaunpur, out of which the share of Lucknow is Rs.47.75 crore. Under this Plan, out of thirty one sanctioned schemes, twenty nine schemes have been completed.

### Gomti Action Plan (GoAP) Phase-II

The sanctioned cost of Gomti Action Plan Phase-II at Lucknow is Rs.263.04 crore. The project cost is to be shared in the ratio of 70:30 between Government of India and State Government. The works in this phase will include two sewage treatment plants of a total capacity of 375 MLD (over and above the 47 MLD capacity being set up in the first phase), interception & diversion works of sewage of the remaining drains and other miscellaneous items such as river front development, toilets, plantation, public awareness and participation, and acquisition of land. Out of thirty schemes, works on seven schemes have been completed.

## Damodar Action Plan (DAP)

The scheme of Damodar Action Plan was approved in October 1996 on 100% funding pattern with stipulated period of implementation up to December 2005 covering eight towns namely, Bokaro-Kargali, Chirkunda, Dighda, Jharia, Ramgarh, Telmachu, Sindri & Sudamdih in the State of

Jharkhand and Andal, Asansol, Durgapur & Raniganj in the State of West Bengal.

In the State of Jharkhand, all of four sanctioned projects of low cost sanitation in Bokaro-Kargali, Ramgarh, Telmachu & Sudamdih have been completed.

In the State of West Bengal out of ten sanctioned projects eight projects relating to low cost sanitation and improved wood crematoria in the covered towns have been completed. The projects of Interception & Diversion and STP of 13.17 mld capacity is created so far.

### **Mahananda Action Plan (MAP)**

A project for the abatement of pollution of River Mahananda at Siliguri town in West Bengal under NRCP at an sanctioned cost of Rs.54.88 crore has been approved under the Ganga Action Plan, Phase-II. The cost of the project will be shared on 70:30 cost sharing basis between the Central and the State Government. The project includes schemes of Interception & Diversion, Sewage Treatment Plant & River Front Development in Siliguri town

### **Other River Action Plans**



Besides the river Ganga and its tributaries covered under GAP-I and GAP-II, the NRCD has taken up the pollution abatement projects of fourteen other States covering thirty three rivers and seventy one towns.

The schemes of GAP-II and other rivers of the country have been merged under National River Conservation Plan based on 70:30 funding pattern and river water pollution abatement works under this head.

The sanctioned cost for the NRCP projects is Rs.4691.55 crore, out of which an amount of Rs.2937.07 crore has been released by the GOI so far. Eight hundred and two projects have been completed against a total of one thousand eighty five sanctioned projects. A target of 4246 mld sewage treatment capacity sanctioned on the basis of DPRs within the approved cost of the respective projects, a capacity to treat 3095 mld of sewage has been created till September 2009, besides 869 mld capacity already created under the Ganga Action Plan Phase-I

### **Details of Projects Approved/Completed**

Details of projects completed between 01.04.2009 to 31.10.2009 are given in Annexure IV. The list of projects sanctioned between 01.04.2009 to 31.10.2009 are given in Annexure III. It was targeted to create 385.82 mld capacity through commissioning of Sewage Treatment Plants (STP) during the year 2009-10. Against this, a total 241 mld capacity has been completed so far and the works of the remaining STPs are in different stages of completion.

### **Water Quality Management Plan for River Ganga**

The water quality of river Ganga is being monitored since 1986 from Rishikesh in Uttaranchal to Uluberia in West Bengal by institutions such as Pollution Control Research Institute (Hardwar), CPCB Zonal Office Lucknow, Indian Institute of Technology, Kanpur, Patna University and Bidhan Chandra Krishi Vishwavidyalaya, Kalyani. As a result of the projects completed under Ganga Action

Plan, the water quality of river Ganga has shown a general improvement despite tremendous population growth along the river banks. Water quality monitoring carried out by reputed institutions such as, IIT, Kanpur, Bharat Heavy Electrical Limited (BHEL), Patna University, etc. indicates that, water quality of the river Ganga conforms to the prescribed standards in terms of key indicators, namely, Bio-chemical Oxygen Demand (BOD) and Dissolved Oxygen (DO) at most of the locations, except in the stretch between Kannauj and Varanasi in Uttar Pradesh.

The summer average values of two important river water quality parameters viz. Dissolved Oxygen (DO) and Biochemical Oxygen Demand (BOD) recorded in some of the important monitoring stations on river Ganga is given in Table-21.

The water quality monitoring has also been undertaken for rivers namely, Yamuna, Western Yamuna Canal, Gomti, Hindon, Satluj (Punjab), Cauvery (Tamil Nadu), Tunga, Bhadra, Tungbhadra in Karnataka and Waterways of Chennai. The number of

**Table-21.** Summer Average Values for Water Quality on River Ganga under Ganga Action Plan

Monitoring Station	Distance in Km	Dissolved Oxygen*		Biochemical Oxygen Demand*	
		(mg/l) 1986	2009	(mg/l) 1986	2009
Rishikesh	0	8.1	8.00	1.7	1.00
Hardwar D/S	30	8.1	7.80	1.8	1.30
Garhmukteshwar	175	7.8	7.90	2.2	2.00
Kannauj U/S	430	7.2	7.20	5.5	1.50
Kannauj D/S	433	NA	7.60	NA	4.80
Kanpur U/S	530	7.2	7.50	7.2	3.80
Kanpur D/S	548	6.7	7.50	8.6	3.90
Allahabad U/S	733	6.4	8.13	11.4	6.25
Allahabad D/S	743	6.6	8.13	15.5	4.00
Varanasi U/S	908	5.6	7.83	10.1	3.83
Varanasi D/S	916	5.9	7.72	10.6	3.10
Patna U/S	1188	8.4	7.03	2.0	1.60
Patna D/S	1198	8.1	6.88	2.2	2.17
Rajmahal	1508	7.8	6.53	1.8	1.65
Palta	2050	NA	7.23	NA	2.77
Uluberia	2500	NA	5.45	NA	2.47

\* Mean value for the months of March to June when the temperatures are high and flows are low.  
NA — Data not available, U/S — Upstream, D/S — Downstream, mg/l — milligram per litre

monitoring stations presently are one hundred fifty eight in ten rivers which include twenty seven stations set up in the upper reaches of Ganga and thirty two stations of Chennai Waterways.

### National Lake Conservation Plan (NLCP)

#### Objectives

The objective of the Scheme is to restore and conserve the polluted lakes in urban and semi-urban areas of the country degraded due to waste water discharge into the lake. The activities covered under National Lake Conservation Plan (NLCP) include the following:-

- Prevention of pollution from point sources by intercepting, diverting and treating the pollution load entering the Lakes from the entire lake catchment area.
- In-situ measures of Lake cleaning such as de-silting de-weeding, bio-remediation etc. depending upon the site conditions.
- Catchments area treatment which may include bunding, afforestation, storm water, drainage, fencing and shore line development etc.
- Public awareness and public participation
- Other activities depending upon location specific conditions including public interface.

#### Projects approved under NLCP

National Lake Conservation Plan (NLCP) is a Centrally Sponsored Scheme of Ministry of Environment & Forests, Government of India for conservation/restoration of polluted and degraded lakes. The scheme of National Lake Conservation Plan was initiated with the approval of conservation and management plans of three lakes namely, Powai (Maharashtra), Ooty and Kodaikanal (Tamil Nadu), in June, 2001 at a cost of Rs. 14.90 crore.

So far under NLCP, a total of forty projects for conservation of fifty eight lakes have been sanctioned in fourteen States at a sanctioned cost of Rs. 883.94 crore (Annexure-III). Conservation works for eighteen lakes have been completed so far



Fig-31. Wular Lake in Meghalaya



whereas in some cases the project implementation is in last stages of completion. Funding pattern under NLCP is on a 70:30 cost sharing between the Central and the State Government.

### NLCP Guidelines

With the experience gained in implementation of projects sanctioned under the NLCP, it was considered imperative to make successive improvements in the existing system of project formulation and implementation. In the process, many of the eminent experts in the field, concerned State Governments/Implementing Agencies and all relevant stakeholders were consulted. The existing guidelines of NLCP have since been revised after due incorporation of responses of State Governments and experts feedback. The revised NLCP guidelines are accessible on the Ministry's website.

### Budget Allocation

Budget Allocation for 2009-10 under National River Conservation Plan and National Lake Conservation Plan is given in Table-22.

The names and addresses of State Implementing Agencies under NRCP is given at Annexure-VI.

### National Wetland Conservation Programme (NWCP)

#### Introduction and Objectives

The scheme on conservation and management of wetlands was initiated in 1987 with the following objectives:-

- to lay down policy guidelines for implementing programme of conservation and management of wetlands in the country,

Table-22. Budget allocation under NRCP and NLCP during 2009-10

(Rs. in crore)

Sl. No	Name of the Plan	Budget Estimate	Revised Estimate (Proposed)	Expenditure (October 2009)
1	National River Conservation Directorate (NRCD)	6.33	7.23	3.55
2	National River Conservation Plan (NRCP)	526.00	526.00	196.83
3	National Lake Conservation Plan (NLCP)	45.00	45.00	20.22
	<b>Total</b>	<b>577.33</b>	<b>578.23</b>	<b>220.60</b>

- to undertake priority wetlands for intensive conservation measures,
- to monitor implementation of the Programme of conservation, management and research,
- to prepare an inventory of Indian wetland

With the above objectives, a National Committee on Wetlands was constituted. Functions of the Committee are:

- To advise the Government on appropriate policies and action programmes for conservation and wise use of Wetlands.
- To review the recommendations of Expert Group on Wetlands.
- Review of progress in implementation of Management Action Plans.
- To advise on collaboration with international agencies on issues related to Wetlands

An Expert Group on Wetlands (EGOW) has also been set up for discussing management action plans of newly identified wetland and identification of new wetlands for the conservation and management. Functions of the Group are:

- Identification of new wetlands for conservation under NWCP.
- In-depth examination of Management Action Plans of the newly identified wetland as per guidelines prescribed by the Government of India.
- Suggest amendments to guidelines, if any, for identification of new wetlands, for formulation of Management Action Plan

and for identification of priority areas of research.

- Over the years, based on the recommendations of National Wetlands Committee, one hundred fifteen Wetlands have been identified so far for conservation under the National Wetland Conservation Programme (Annexure-VII).
- The Research projects to supplement Management Action Plans (MAPs) for intensive conservation on thrust areas of research are considered by the Thematic Group for conservation of Wetlands and Mangroves constituted by RE Division in the Ministry. List of the research project sanctioned during 2009-10 is given in Annexure-III.

#### Activities undertaken so far

#### National Wetland Conservation Programme (NWCP)

Main Activities under MAPs of Wetlands for which funds provided, include:

- Survey and demarcation
- Catchment area treatment
- Protection measures
- Fisheries development
- Weed control
- Wildlife conservation
- Pollution abatement
- Research on various aspects of Wetlands
- Eco-development activities
- Education and awareness

To supplement the Management Action Plans, assistance is also given for research

& developmental activities in various thrust areas of research which are as follows:

- Survey and assessment of resources
- Value of wetlands
- Hydrological functions and assessment of associated values
- Assessment and conservation of wetland biodiversity
- Anthropogenic pressures and natural calamities
- Socio-economic aspects

### Progress/Achievements made during the year

- During the year, Management Action Plans of twenty seven wetlands have been approved and financial assistance released to the concerned State Governments. So far, an amount of Rs.11.22 crores has been released (till 24.02.2010) against the total allocation of Rs.11.90 crores during 2009-10.
- The meeting of National Wetlands Committee was held on 16.03.2009 in the Ministry under the Chairmanship of Secretary (E&F) which approved the inclusion of twelve more wetlands under the NWCP increasing total number of wetlands from one hundred three in 2008 to one hundred fifteen in 2009 covering twenty four states and two UTs.
- The meeting of Expert Group on Wetlands (EGOW) was held on 16.11.2009 in which three more wetlands were recommended for inclusion in the list identified wetlands under NWCP.

- Two regional workshops at Coimbatore and Amity University, Noida were organized during the current financial year for providing training to wetland managers for implementation of Management Action Plans of identified wetlands in the states.
- Regulatory framework for conservation of wetlands was prepared and was put up on the Ministry's website to obtain comments of all the concerned and State Governments. After incorporating all the relevant comments, the draft regulatory framework has been finalized and has been sent to Ministry of Law and Justice for vetting. Thereafter it will be notified under EP Act-1986.
- Guidelines for National Wetland Conservation Programme have been revised.

### International issues and Ramsar Convention

- India is also a Party to the United Nations Framework Convention on Climate Change (UNFCCC), Convention on Biological Diversity, Convention on Conservation of Migratory Species of Wild Animals, Convention on World Heritage, Supervisory Council of Wetland International, etc. Inter-linkages among these Conventions are frequently discussed in the inter-Ministerial and intra-Ministerial meetings to develop comprehensive plans on actions for their implementation.
- Twenty five sites have already been designated as Ramsar sites in India till date. (Annexure-VII). Six (6) more wetlands are under process of being designated as Ramsar sites.



## Ministry of Environment & Forests

---

- Out of Rs. 86.68 crores released so far under NWCP, an amount of Rs.56.01 crores has been released for conservation of twenty one Ramsar Sites out of twenty five Ramsar Sites. The funds have been provided on the basis of management action plans submitted by the concerned state Govts.
- India was re-nominated as Member of Supervisory Council for another term (2008-2011) on the basis of its achievement for conserving Wetlands of the country.
- India is also a partner to the Himalayan initiatives along with other Himalayan countries. A Himalayan initiative was recently endorsed by the Indian Government in 2008

### State wise status

### Regulatory Acts/Rules governing the programme and promulgation of new acts

Regulatory framework for conservation of wetlands was prepared and

was put up on the Ministry's website to obtain comments of all the concerned and State Governments. After incorporating all the relevant comments, the draft regulatory framework has been finalized and has been sent to Ministry of Law and Justice for vetting. Thereafter it will be notified under EP Act-1986.

### Budget allocation

An allocation of Rs. 11.90 crore has been made during the year 2009-10 for conservation and management of identified wetlands. So far an expenditure of Rs.11.22 crore has been incurred till 24.02.2010.

### Implementing organizations

Department of Environment and Forests, Council for Science and Technology, State Wetland Authority of the concerned states are the nodal departments for implementing various conservation activities in states where wetlands have been identified under NWCP.

An aerial photograph of a lush green forest valley. The foreground is dominated by dense, vibrant green trees. In the middle ground, a winding road or path cuts through the forest. The background features a range of mountains under a hazy, overcast sky. The overall scene conveys a sense of natural beauty and environmental health.

**CHAPTER – 6**  
**REGENERATION AND**  
**ECO-DEVELOPMENT**

## National Afforestation and Eco-Development Board (NAEB)

### Introduction

In order to promote afforestation, tree planting, ecological restoration and eco-development activities in the country, the National Afforestation and Eco-Development Board (NAEB) was set up in August 1992. Special attention is also being given by NAEB to the regeneration of degraded forest areas and lands adjoining forest areas, national parks, sanctuaries and other protected areas as well as the ecologically fragile areas like the Western Himalayas, Aravallis, Western Ghats etc.

### Objectives

The detailed objectives of the NAEB are to:

- Evolve mechanisms for ecological restoration of degraded forest areas and adjoining lands through systematic planning and implementation, in a cost effective manner;
- Restore through natural regeneration or appropriate intervention the forest cover in the country for ecological security and to meet the fuelwood, fodder and other needs of the rural communities;
- Augmentation of availability of fuelwood, fodder, timber and other forest produce on the degraded forest and adjoining lands in order to meet the demands for these items;
- Sponsor research and extension of research findings to disseminate new and proper technologies for the regeneration and development of degraded forest areas and adjoining lands;

- Create general awareness and help foster a people's movement for promoting afforestation and eco-development with the assistance of voluntary agencies, non-government organizations, Panchayati Raj institutions and others and promote participatory and sustainable management of degraded forest areas and adjoining lands;
- Coordinate and monitor the Action Plans for tree planting, ecological restoration and eco-development; and
- Undertake all other measures necessary for promoting afforestation, tree planting, ecological restoration and eco development activities in the country.

### Name of the Schemes

NAEB operates the following three major schemes:

- (a) National Afforestation Programme (NAP) Scheme
- (b) NAEB Scheme: The major components of the Scheme are:-
  - i. Grants in Aid for Greening India (GIA for GI) Scheme
  - ii. Monitoring and Evaluation (M&E)
  - iii. Communication
  - iv. Support to Regional Centres (RCs)
- (c) Eco Development Forces (EDF)

## National Afforestation Programme (NAP) Scheme

### Introduction and Objectives

It continues to be the flagship scheme of NAEB, in so much as it provides support, both in physical and capacity building terms,

to the Forest Development Agencies (FDAs) which in turn are the main organ to move forward institutionalization of Joint Forest Management. The FDA has been conceived and established as a federation of Joint Forest Management Committees (JFMCs) at the Forest Division level to undertake holistic development in the forestry sector with people's participation. This is a paradigm shift from the earlier afforestation programmes wherein funds were routed through the State Governments. This decentralized two-tier institutional structure (FDA and JFMC) allows greater participation of the community, both in planning and implementation, to improve forests and livelihoods of the people living in and around forest areas. The village is reckoned as a unit of planning and implementation and all activities under the programme are conceptualized at the village level. The two-tier approach, apart from building capacities at the grassroots level, significantly empowers the local people to participate in the decision making process. Under Entry Point Activities, community assets are created with a 'care and share' concept. The objectives of the scheme are as follows:

- Protection and conservation of natural resources through active involvement of the people.
- Checking land degradation, deforestation and loss of biodiversity
- Ecological restoration and environmental conservation and eco-development
- Evolving village level people's organization which can manage the natural resources in and around villages in a sustainable manner

- Fulfillment of the broader objectives of productivity, equity, and sustainability for the general good of the people
- Improve quality of life and self-sustenance aspect of people living in and around forest areas
- Capability endowment and skill enhancement for improving employability of the rural people.

### Progress and Achievements during the year

- Eight hundred FDAs have been operationalised so far, since the launch of the FDA mechanism in 2000-01, at a cost of Rs. 3,131.48 crores to treat a total area of 16.90 lakh ha. (as on 22.02.2010). Rehabilitation of shifting cultivation lands have been given specific focus under the programme, and so far thirty five jhum projects have been sanctioned in NE States and in Orissa..
- As on 22.02.2010, Rs. 311.90 crore was released to FDAs during the year 2009-10 for implementation of National Afforestation Programme (NAP).

### Implementing organization

The NAP Scheme is being implemented through two-tier decentralized mechanism of Forest Development Agency (FDA) at Forest Division Level and Joint Forest Management Committees (JFMCs) at the village level.

### Comparison of progress as compared to previous years

Year-wise progress of National Afforestation Programme in the Tenth Five Year Plan and during the current Plan period and

## Ministry of Environment & Forests

State-wise Status of FDA Projects are given in Table-23 and Table-24.

### New initiatives under the Scheme

A number of initiatives have been taken by the Ministry to expedite the implementation of the scheme as well improve the qualitative aspects of implementation. These include :

- Stepping-up monitoring and evaluation of the FDA projects by activation of State-level Coordination Committees for NAP, increased field visit by officers, and expeditious commissioning by the States of first independent concurrent evaluation of FDA projects
- Increased number of training programmes for the frontline staff and JFM committee members
- Organising district-level inter-departmental linkage workshops for promoting linkage of NAP with other developmental programmes for enhancing the sustainability of JFM
- Initiating seven pilot projects for establishing forest-based micro-enterprises which will provide experiential learning for scaling-up such activity with a view to consolidate the JFM during the Eleventh Plan.
- Comprehensive amendment in Guidelines of NAP scheme has been made to promote further decentralization by delegating more responsibilities to State Forest Departments with respect to processing of the FDA project proposals, greater organic linkage of JFMCs with Gram Panchayats, increased security of the elected members of JFMCs through

**Table-23.** Year-wise progress of National Afforestation Programme (2002-03 till date)

Year	No. of New FDA projects approved	No. of New JFMCs involved	Project Area approved (ha.)*	Release (Rs. in crores)
2000-02	47	1843	71068	47.53
2002-03	237	8197	404799	151.26
2003-04	231	7902	282536	207.98
2004-05	105	3404	106743	233.00
2005-06	94	2362	54432	248.12
2006-07	15	494	0	292.75
2007-08	53	3979	493061	392.95
2008-09	13	6598	173435	345.62
2009-10	5	7716	104409	311.90
(As on 22.02.2010)				

\* Area approved for advance soil work/preparatory plantations during the year for all ongoing FDA projects.

\*\* Total (financial assistance provided during the year for planting, advance soil work, maintenance etc.) for all ongoing FDA projects.



Table-24. State-wise status of FDA Projects as on February 22, 2010

Sl. No.	Name of State/Union Territory	No. of FDA Projects/ Proposals sanctioned	Total project cost (in Rs. crores)	Total JFMCs	Area (in ha.)	Total Releases (in Rs. Crores)
1	Andhra Pradesh	47	129.76	2555	72623	83.90
2	Chhattisgarh	32	223.73	2611	106160	157.69
3	Gujarat	25	211.76	2027	82705	127.38
4	Haryana	19	128.35	2265	44189	102.22
5	Himachal Pradesh	30	81.82	1556	44883	58.73
6	Jammu & Kashmir	31	109.69	1836	65529	55.28
7	Karnataka	45	212.34	1560	96155	157.84
8	Madhya Pradesh	55	208.87	3270	124332	143.29
9	Maharashtra	48	205.03	3092	119227	134.69
10	Orissa	46	157.69	3547	123307	105.99
11	Punjab	15	38.07	1192	18209	21.91
12	Rajasthan	33	68.95	1059	46890	50.56
13	Tamil Nadu	32	130.83	1580	68192	101.73
14	Uttar Pradesh	69	241.21	2752	130670	193.23
15	Uttarakhand	38	98.33	1900	65576	72.34
16	Goa	3	2.39	26	1250	0.64
17	Jharkhand	34	160.43	2522	97050	118.09
18	Bihar	10	45.12	978	28531	34.12
19	Kerala	27	87.28	615	31816	45.68
20	West Bengal	20	67.48	1960	38248	46.16
	<b>Total (Other States)</b>	<b>659</b>	<b>2609.15</b>	<b>38903</b>	<b>1405542</b>	<b>1811.49</b>
21	Arunachal Pradesh	23	40.44	481	30121	25.40
22	Assam	30	80.28	810	52255	61.07
23	Manipur	16	67.91	578	35144	54.80
24	Nagaland	19	71.12	456	43718	62.08
25	Sikkim	8	65.95	244	26003	54.60
26	Tripura	13	40.61	271	29335	29.49
27	Mizoram	24	123.96	528	50120	106.25
28	Meghalaya	8	32.06	224	18245	25.91
	<b>Total (NE States)</b>	<b>141</b>	<b>522.33</b>	<b>3592</b>	<b>284941</b>	<b>419.61</b>
	<b>TOTAL</b>	<b>800</b>	<b>3131.48</b>	<b>42495</b>	<b>1690483</b>	<b>2231.10</b>

longer tenure of JFMC presidency, capacity building of particular frontline staff of Forest Department and JFMC members especially with regard to local management and administrative responsibilities.

## Grants in Aid for Greening India Scheme

### Introduction and Objectives

Increasing forest and tree cover (FTC)

of the country to one-third of its geographical area, as envisaged in the National Forest Policy 1998, is essential for economic and ecological security of the country. Achieving the target of one-third of FTC, however, stipulates fourfold increase in the current annual tree planting rate in the country, and that too, mostly on lands outside recorded forest area (RFA) wherein non-forest organizations and the custodian institutions can play a significant role. The scheme 'Grants-in-Aid Scheme, providing assistance to Voluntary agencies for tree planting' (GIS) was started for encouraging participation of the interested Non-Government Organisations as well as Government Institutions. It has been observed that for raising tree plantations on lands outside RFA, economic return is the major driving force. These could be encouraged if returns to the growers were made attractive. The wanting economic return are largely attributed to the low volume and poor quality yield of tree products. The main reason for this that the tree growers do not have easy access to quality planting material (QPM) due to both paucity of QPM production facilities in the rural areas and low awareness about gains of using QPM. Recognizing these

constraints, the then existing Grants-in-Aid Scheme was restructured by incorporating additional components of QPM production facilities and creation of mass awareness about QPM. This was renamed as "Grants in aid for Greening India" Scheme and three aspects expressly stated:-

- a) Raising mass awareness about QPM and tree planting
- b) Enhancing the capacity for QPM production
- c) Tree planting with people's participation

Now, all these aspects have been wholly subsumed in a new proposed scheme, 'Gram/Panchayat Van Yojana', which is also aimed at afforestation/tree planting in non-forest land on a much larger scale. To lessen multiplicity of schemes with similar objectives, sanction of new project proposals under GIS have been discontinued w.e.f. 2008-09. The ongoing projects, however, will continue to be supported till completion

#### Progress/Achievement made during the year

Financial assistance of Rs.0.90 crores has been provided to twenty four agencies for ongoing tree planting projects as on 22.02.2010.

#### Budget Allocation of the Scheme and Progress of Expenditure

The revised Budget Estimate for ongoing projects under the Scheme for 2009-10 was Rs.1.00 crores, out of which Rs.0.90 crores has been released upto 22.02.2010.

#### Comparison of progress over the years

Table-25 reflects the progress of number of projects for tree planting



Fig-32. Hightech Nursery at Turid, Aizwal

supported under the previous 'Grants-in-Aid to Voluntary Agencies' scheme (until 2004-05) and the present 'Grants-in-Aid for Greening India' Scheme till the current financial year 2009-10.

#### Implementing organization along with details

The scheme is being implemented by government Departments, Urban Local Bodies, Panchayati Raj Institutions, Public Sector Undertakings, Autonomous Bodies, Registered Societies, Non-Profit Organizations, Cooperatives, Charitable Trusts, Voluntary Agencies, Registered Schools, Colleges, Universities and State Forest Departments. Voluntary Agencies are implementing majority of Tree Planting projects.

#### Eco-Development Forces (EDF) Scheme

##### Introduction and objective

Eco-Development Forces was established in 1980s as a scheme being

implemented through Ministry of Defence for ecological restoration of terrains, rendered difficult either due to severe degradation or remote location or difficult law and order situation. The scheme of Eco Development Force is based on twin objectives of ecological regeneration in difficult areas, and promotion of meaningful employment to ex-servicemen.

Under this scheme, the establishment and operational expenditure on the Eco Task Force (ETF) Battalions raised by Ministry of Defence is reimbursed by Ministry of Environment and Forests while the inputs like sapling, fencing, etc. as also the professional and managerial guidance is provided by the State Forest Departments. In ETF battalions, the MOD deploys its ex-servicemen, preferably from within the area of operation, whereas the nuclear core of the force is constituted of regular servicemen. Some of the ETF Battalions have undertaken successful eco-restoration of highly degraded sites, for example the limestone mining areas in the Mussoorie Hills.

**Table-25.** Progress under the previous 'Grants-in-Aid to Voluntary Agencies' and the present 'Grants-in-Aid for Greening India' Scheme

Year	No. of tree planting projects supported*	Expenditure (Rs. in Cr.)**
2002-03	141	4.00
2003-04	251	8.49
2004-05	266	8.97
2005-06	211	11.76
2006-07	109	5.86
2007-08	129	8.48
2008-09***	85	3.95
2009-10***	26	0.90

\* Includes ongoing projects, sanctioned in previous years also.

\*\* Includes grants given for Awareness Generation, High- Tech Nursery and Tree Planting components of the Grants in Aid for Greening India Scheme.

\*\*\* Includes only on-going projects as no new project was sanctioned.

### Activities undertaken so far

Six ETF battalions are being supported under the EDF Scheme in the States of Uttarakhand, Rajasthan, Jammu & Kashmir and Assam.

### Progress/Achievements made during the year

The progress of ETF Battalions during the year 2009-10 is given in Table-26.

All ETF Battalions have undertaken works like raising nursery and plantation and protection measures to protect the plantation area. They have also constructed stone dams as also other soil and moisture conservation works. Besides, the battalions also take up maintenance of old plantations.

Closer monitoring of physical progress and coordination between the Ministry, Territorial Army and State Governments has witnessed for timely availability of land and other resources for planting, redeployment/disembodying of surplus ETF personnel in order to cut down costs, and further improvement in the quality of work.

### Budget Allocation of the scheme and progress of expenditure

Budget Estimate for the scheme during 2009-10 is Rs.10.50 crore out of which Rs.9.64 crores has been reimbursed to Ministry of Defence upto 22.02.2010.

### Implementing Organizations along with details

Directorate of Territorial Army, Ministry of Defence, New Delhi

### New Initiatives

Four ETF Battalions are already operational. From the financial year 2007-08 two more Battalions are functional in the State of Assam.

## Regional Centres of NAEB

### Introduction and objectives

The Board has seven Regional Centres located in various universities/national level institutions (Annexure-II). These Centres help NAEB in promoting extension of replicable technologies and for dissemination of research findings. They provide technical and extension support to the State Forest Departments in effective implementation of regeneration of degraded forests and adjoining lands with people's participation and also act as a forum for the exchange of ideas and experiences amongst the States of the region as well as across the regions. In addition, these Centres carry out problem-specific studies as well as evaluation of NAEB's programmes in the field and organize training programmes and workshops focusing on priorities set out by the Board.

### New initiatives of Regional Centres

The work programmes of the Regional Centres are being formulated to address the emerging needs of promoting sustainability of Joint Forest Management beyond the NAP scheme funding. The new areas include training for forest-based micro-enterprises, development of Joint Forest Management Committees, Self Help Groups, district-level inter-departmental linkage workshops for synergy of JFM with other schemes of Government and studies on improved silvicultural practices for management of non-timber forest products. Seven pilot projects on capacity building for forest based micro-enterprise have been initiated by the Regional Centres across the country. It is hoped that based on the experience of these pilots, the forest-based microenterprise could be scaled-up as a means of promoting sustainable livelihoods of the forest-fringe communities.

**Table-26.** The progress of ETF Battalions during the year 2009-10 (as on 30th September, 2009).

Battalion	Location	New Plantation during the year		Maintenance of old Plantation	
		No. of Plants	Area in ha.	No. of Plants	Area in ha.
127 Inf Bn(TA) Eco	Uttarakhand	4.00 lakh	400	0.41 lakh	40
128 Inf Bn(TA) Eco	Rajasthan	1.36 lakh	270	7.73 lakh	1360
129 Inf Bn(TA) Eco	Jammu & Kashmir	0.62 lakh	75	0.87 lakh	73
130 Inf Bn(TA) Eco	Uttarakhand	5.00 lakh	500	5.00 lakh	500
134 Inf Bn(TA) Eco	Assam	3.82 lakh	591	2.77 lakh	300
135 Inf Bn(TA) Eco	Assam	5.20 lakh	520	3.92 lakh	392

### United Nations Convention to Combat Desertification (UNCCD)

#### Introduction and objectives

The United Nations Convention to Combat Desertification with 193 Parties, is one of the three Rio Conventions focusing on desertification/land degradation and drought which have become global environmental challenges. The convention aims at arresting and reversing land degradation and can, on implementation, significantly contribute to achieving the Millennium Development Goals (MDGs) as well as sustainable development.

India became a signatory to the convention on 14<sup>th</sup> October, 1994 and ratified it on 17<sup>th</sup> December, 1996. As per the Desertification and Land Degradation Atlas of India published by the Space

Application Centre in 2007, about 32.7% of the land is undergoing various forms of degradation. India has thus high stakes and stands strongly committed to implementing it. The Ministry of Environment and Forests is the nodal Ministry in the Government of India for the UNCCD, and Desertification cell of the National Afforestation and Eco-



Fig-33. Thar Desert

development Board (NAEB) is the nodal point within the Ministry to co-ordinate all issues pertaining to the convention.

Though the country does not have a specific policy or legislative framework for combating desertification as such, the concern for arresting and reversing land degradation and desertification gets reflected in many of our national policies which have enabling provisions for addressing these problems. It is also implicit in the goals of sustainable forest management (SFM), sustainable agriculture, sustainable land management (SLM) and the overarching goal of sustainable development which the country has been pursuing. The subject has in fact been engaging the attention of our planners and policy makers since the inception of planning. The first five year plan (1951-1956) had 'land rehabilitation' as one of the thrust areas. In the subsequent plans too, high priority has been consistently attached to development of the drylands in consideration of the fact that about 69% of the country's lands are drylands and degradation of these lands has severe implications for the livelihood and food security of millions.

India formulated and submitted in 2001 a National Action Programme (NAP) to combat desertification, in accomplishment of one of the obligations that parties to the Convention (UNCCD) are required to fulfill. A broad roadmap to combating desertification, NAP recognizes the multi sectoral nature of the task, in view of the fact that many of the drivers of desertification have cross cutting dimensions.

### Progress of Activities undertaken

– As in earlier years, the world over, June

17 was celebrated as World Day to Combat Desertification. For the year 2008, the theme of the day was "Conserving land and water = Securing our common future". The Ministry organised a workshop on this day at Jaipur. It was attended by senior government officials and others representing the stakeholder ministries of the Government of India and the state Governments as well as CSOs.

- A three-member delegation from India led by the Inspector General of Forests (NAEB) participated in the Ninth session of the Conference of Parties to the UNCCD (COP 9) which convened in Buenos Aires, Argentina, from 21<sup>st</sup> September – 2<sup>nd</sup> October, 2009, along with the Eighth session of the Committee for the Review of the Implementation of the Convention (CRIC 8) and the Ninth session of the Committee on Science and Technology (CST 9). The agenda items included *inter alia* four-year work plans and two-year work programmes of the CRIC, CST, Global Mechanism (GM) and the Secretariat, the Joint Inspection Unit (JIU) assessment of the GM, the terms of reference of the CRIC, arrangements for regional coordination mechanisms (RCMs), impact indicators and performance indicators, the communication strategy and the programme and budget. Being the chair of the fifty six country strong Regional Implementation Annexe for Asia and an active member of the G77/China, India could successfully lobby and mobilize opinion in support of its concerns which it felt were important for the country and in the larger interest of the developing countries and the convention, and thus made a significant contribution to the negotiations.



**CHAPTER - 7**  
**RESEARCH**

### Environmental Research

#### Introduction

Ministry of Environment & Forests has been funding research in multi-disciplinary aspects of environmental and ecosystems protection, conservation and management at various universities, institutions of higher learning, national research institutes and non-governmental organizations in identified thrust areas under its Research & Development (R&D) Programme. The Research & Development Scheme of the Ministry is a Central Plan Scheme for conservation and management of environment since 1985.

#### Objectives

The objective of the scheme is to generate information required to develop strategies, technologies and methodologies for better environmental management. It also aims at attempting solutions to the practical problems of resource management, conservation of natural resources and eco-regeneration of degraded areas. Further, the scheme also seeks to strengthen infrastructure to facilitate research and scientific manpower development. In order to achieve these objectives, research grants are provided in the identified thrust areas to various organizations (universities, colleges recognized by University Grant Commission (UGC), institutions of Council of Scientific and Industrial Research (CSIR), Indian Council of Agriculture Research (ICAR), Indian Council of Medical Research (ICMR), Indian Council of Social Science Research (ICSSR) and recognized non-governmental scientific organizations) all over the country.

The Ministry has brought out revised guidelines in 2006 for supporting research

in Environment which inter-alia include thrust areas of research and their prioritization.

The Ministry supports research through its established research programmes. These include Environment Research Programme (ERP), Ecosystem Research Scheme (ERS), Eastern and Western Ghats Research Programme (E&WGRP) and Economic & Social Issues. Thematic Expert Groups for these research programmes have been constituted to screen evaluation and recommend new projects and also to monitor/review the ongoing projects. The list of sanctioned projects and completed projects during the current financial year are given in Annexure-III and Annexure-IV respectively. The Ministry also promotes research in Environment through the awards of National Fellowships to the outstanding Scientists. These awards are Pitambar Pant National Environment Fellowship Award in Environmental Science and Dr. B.P. Pal National Environment Fellowship Award for Biodiversity.

#### Programme-wise Progress and Activities

#### Environment Research Programme (ERP)

Environment Research Programme (ERP) deals with problems related to pollution and development of suitable cost effective technologies for abatement of pollution. Emphasis is laid on development of eco-friendly biological and other interventions for prevention, abatement of pollution and development of strategies, technologies and instruments etc. for control of pollution. Projects are also encouraged for development of biodegradable plastics, to carryout



epidemiological studies, strategies to reduce impact of mining, chemical pollution of soils, and hazardous substances including pesticides, heavy metals etc. Projects related to waste recycling and resource recovery from waste along with the development of eco-friendly and cleaner technologies are given priority. The projects are supported in the identified thrust area of environment research.

Under the Thematic Group 'Prevention, Abatement and Control of Pollution', three Programmes / Schemes are covered namely i) Environment Research ii) National River Conservation and iii) Climate Change / Clean Technologies. During the financial year (up to 23.02.2010) Five meetings of the Thematic Group were held to consider the new / revised/ comments received new proposals & review / monitor the ongoing / completed projects. Total one hundred sixty eight proposals were considered by the Expert Group of which forty nine are recommended. Based on the recommendations of the Expert Group twenty eight new projects have been sanctioned during the period. Progress of forty nine ongoing projects was reviewed and monitored, twenty five revised and forty three comments received proposals considered during the year. The Expert Group also reviewed the Final Technical Report (FTR) of six completed projects during the period (up to 23.02.2010).

### **Ecosystem Research Scheme (ERS)**

Ecosystem Research Scheme is an interdisciplinary programme of research which emphasizes ecological approach for studying the relationship between man and environment. The objective of the programme is to develop a basis within the field of natural and social sciences for rational use and

conservation of resources for general improvement of the relationship between man and his environment. The programme seeks to provide a scientific basis to solve the practical problems of resource management. The programme also seeks to provide a scientific knowledge and trained personnel needed to manage the natural resources in a rational and sustainable manner. Ecosystem studies become even more important as the Earth's environmental ecosystems are increasingly being affected at all levels. Ecological understanding and research in this area offer tangible hope for addressing extremely complex and potentially devastating assaults on local, regional and global ecosystems. Under the scheme, emphasis is laid on multi-disciplinary aspects of environmental conservation with emphasis on eco-system approach consistent with the identified thrust areas and orientation.

During the year under Ecosystem Research Scheme four new projects were initiated, seven studies were completed and fifteen projects were reviewed and monitored for their progress.

### **Eastern and Western Ghats Research Programme (E&WGRP)**

The Eastern and Western Ghats Research Programme addresses itself to location-specific problems of resource management in the Eastern and Western Ghats regions of the country. The region is suffering from destruction of habitats of its unique plant and animal life due to floods, hoalson, deforestation etc. besides shortage of food, fodder and fuel for rural population and shortage of raw material for the industries. Under this programme, studies relating to Bio-diversity, land use, impact of developmental

activities etc. are taken up to restore the environmental quality of the region.

During the year under E&WGRP two new projects were initiated, twelve studies were completed and twenty one projects were reviewed and monitored for their progress.

### **Thematic Group on 'Economic & Social Issues'**

During the year 2007-08, Ministry has constituted new Thematic Group- 'Economic & Social Issues'. Though no specific programme will be covered under this thematic group, the group would consider all proposals related to cost benefit analysis, socio-economic issues and other miscellaneous issues.

During the year one meeting of the Thematic Group was held to consider the new / revised proposals & review / monitor the ongoing / completed (FTR) projects. Four new and three comments received projects were considered by the Expert Group. Based on the recommendations of the Expert Group one new project has been sanctioned during the period. Progress of one ongoing project was reviewed and monitored during the year. The Expert Group also reviewed the three FTR of completed project during the period.

### **Thematic Group-B on Conservation and Sustainable Utilization of Natural Resources**



Under the Thematic Group-B on Conservation and Sustainable Utilization of Natural Resources', four Programmes are covered namely i) Mangroves and Coral Reefs ii) Wet Lands iii) Biodiversity Conservation iv) Man & Bio-sphere reserves. During the Financial Year (up to 23.02.2010) Two meetings of the Thematic Group were held

to consider the new / revised/ comments received new proposals & review / monitor the ongoing / completed projects. Total one hundred eighty proposals were considered by the Expert Group. Based on the recommendations of the Expert Group twenty new projects have been recommended during the period. Progress of twenty three ongoing projects was reviewed and monitored and fifteen new proposals send for further revision by the Group during the year. The Expert Group also reviewed the Final Technical Report (FTR) of eight completed projects during the period (up to 23.02.2010).

### **Thematic Group-B on Conservation and Management of Wildlife and Animal Welfare**

Under the Thematic Group-B on Conservation and Management of Wildlife and Animal Welfare, two Programmes are covered namely Wildlife Conservation and Animal Welfare. During the Financial Year (up to 31.12.2009) one meetings of the Thematic Group were held to consider the new / revised/ comments received new proposals & review / monitor the on going / completed projects. Total fifty three proposals were considered by the Expert Group. Based on the recommendations of the Expert Group five new projects have been recommended and progress of eighteen ongoing projects was reviewed and monitored during the year. The Expert Group also reviewed the Final Technical Report (FTR) of two completed projects during the period (up to 31.12.2009).

The total allocation for R&D Scheme during 2009-10 is Rs. 6.0 crores. The entire amount is utilized for ongoing and new

projects based on the recommendations of the Thematic Expert Groups.

[Summaries / Research findings of some of the Projects completed during the year](#)

[Studies of the biosystematics of parasitic wasps of Eupelmidae \(Hymenoptera\) of Kerala including Southern Western Ghats by Dr. T.C. Narendran, Department of Zoology, University of Calicut-673635, Kerala](#)

The project was sanctioned to make an inventory of the genera species of Eupelmid fauna existing in Kerala including the adjoining parts of Southern Ghats. During the project period forty eight additional species and four genera were reported. Among these thirty species are new to science. This taxonomic investigation in the Southern Western Ghats unraveled several endemic species of interesting and economically important eupelmid. Only twenty six Eupelmid species in eight genera were known before undertaking this investigation. The complete check-list for all eupelmid species found in Southern Western Ghats were prepared, that can be used as a reference material for further study in taxonomy, biocontrol, agriculture and biodiversity. The bio-geographic distribution data of the Eupelmid species prepared and the need to conserve them is emphasized.

[Behavioural ecology of the lesser Dog faced fruit Bat by Dr. Sripathi Kandula, Department of Animal Behaviour & Physiology, Madurai Kamaraj University, Madurai-625021](#)

The aim of this study was to study the behavioural ecology of the lesser dog-faced fruit bat *Cynopterus brachyotis* in southern Western Ghats. *Cynopterus brachyotis*

occurred only at higher altitudes (800-1500 m or more) of southern Western Ghats and prefer to stay in higher elevations. The day roosts of *Cynopterus brachyotis* at an altitude above 1000 metre in Sirumalai hill range Yercaud have been located. From our radio-telemetry observation, the male and female bats used five & six different foraging areas respectively and the male bats foraged ca. 4 to 4.5 km and the female bats foraged ca. five to six kilometre. Males generally preferred to forage at shorter distances from the day roost whereas the females commutes to longer distance and they had more than one foraging areas. These results suggest that some type of territoriality is associated with shelter, which appears to be the basis of social organization in *Cynopterus brachyotis*.

[Identification of New Thrust / Priority Areas](#)

A State of the Art Report on Bioremediation of Contaminated Sites in India has been given to Prof. MNV Prasad, Central University, Hyderabad and the same is under finalization and publication.

The progress of the project on "Reclamation of copper rich Malajkhanda tailing dam through Bioremediation employing biconsortia of arbuscular mycorrhiza fungi and bacteria" taken up by Madhya Pradesh Pollution Control Board in collaboration with M/s Hindustan Copper Ltd. was reviewed by the Expert Group. The committee has identified some contaminated sites to be taken up under the programme.

[New Initiatives under R&D Scheme](#)

During the year, in addition to the ongoing programmes in the area of Research

in Environment under the R&D scheme, the following four new initiatives have been taken up:

- Institution of MoEF – National Environment Fellow Programmes
- Institution of Mahatma Gandhi Chair for Ecology and Environment
- Collaborative Research Programme with CSIR.
- New Institutions - National Environment Protection Training & Research Institute (NEPTRI).

### Institution of a National Environmental Sciences Fellows Programme

The National Environmental Sciences Fellows Programme, a new initiative under the R&D scheme of the Ministry, was launched by the Minister for Environment & Forests on 4<sup>th</sup> February, 2010. The main objective of this fellowship programme is to provide an opportunity for young scientists-both Indian and of Indian origin- desirous of working at the forefront of environmental sciences and engineering with a focus on problem solving environmental research. It is proposed to select upto ten National Environmental Sciences Fellows every year who would be functioning as Host Institutions. The National Environmental Sciences Fellows will carry out research on the thrust areas identified by the Management Committee constituted for the purpose by the Ministry, at the selected Host Institutions.

A booklet containing detailed guidelines including the proforma for submission of application, Memorandum of Understanding to be entered into between the Host Institutions and MoEF etc. has been

prepared and is available in the website of the Ministry.

### Institution of Mahatma Gandhi Chair for Ecology and Environment

A Mahatma Gandhi Chair for Ecology and Environment has been set up at the Centre for Biodiversity Studies, Baba Ghulam Shah Badshah University, Rajouri, Jammu & Kashmir during 2009-10. The main objective of the Chair is to promote Gandhian thoughts, ideas and philosophy on Environment & Development with a view to attaining sustainable development in the truest sense. The Fellow for the Chair will be selected by a Selection Committee to be constituted by the Vice Chancellor, Baba Ghulam Shah Badshah University, Rajouri, Jammu & Kashmir, in consultation and with the approval of the Ministry.

The selected Fellow will work on any one of the eleven thrust areas identified by the Ministry. Detailed guidelines are under finalisation.

### Collaborative Research Programme with CSIR

During the year action has been initiated to set up a Collaborative Research Programme with CSIR. The thrust areas identified for this programme are as follows:

- Waste water treatment
- Solid waste management
- Reclamation of lakes
- Bioremediation of contaminated sites

A proposal has been received from the National Environmental Engineering Research Institute (NEERI), Nagpur which is under examination.

### National Environment Protection Training & Research Institute (NEPTRI)

It is proposed to set up a specialized National Environmental Institute which will undertake capacity building, research, consultancy and advocacy activities to support the Ministry and other Central & State Government organizations in achieving their environmental mandates and goals. In this regard, it has been decided that the Environment Protection Training & Research Institute (EPTRI), which is owned and operated by the Government of Andhra Pradesh (GoAP), shall be converted into a National Environment Protection Training & Research Institute (NEPTRI), to be operated as a joint venture between Government of India and the GoAP.

The Government of Andhra Pradesh has conveyed its approval for the same and action has been initiated for the setting up of NEPTRI as a joint venture between the Ministry and GoAP.

### National Natural Resource Management System (NNRMS)

The Scheme of National Natural Resource Management System (NNRMS) involves utilization of remote sensing technology for accurate inventory of resources such as land, water, forests, minerals, oceans, etc. and to utilize this information for monitoring changes in ecological system. A Standing Committee on Bio-resources and Environment (SC-B) has been constituted by the Planning Commission under the Chairmanship of Secy. (E&F) with the following objectives:

- Optimal utilization of country's natural resources by a proper and systematic

inventory of resource availability.

- Reducing regional imbalances by effective planning and in tune with the environmental efforts
- Maintaining the ecological balance with a view to evolve and implement the environmental guidelines.

The Standing Committee on Bio-resources and Environment (SC-B) constituted by the Planning Commission advises on the methods of using the remote sensing technology for optimal use and management of natural resources in the country. In order to streamline the projects the SC-B has constituted a Technical & Financial Sub-Committee to scrutinize/review all the proposals submitted for funding under NNRMS SC-B from the technical and financial angle. Only those proposals recommended by the Technical and Financial Sub-Committee are taken up by NNRMS SC-B for financial assistance. The Committee also oversees and monitors the progress of sanctioned projects

### Achievements during the year

During the year, two Meetings of Technical and Financial Sub – Committee of National Natural Resource Management System on Bio-resources and Environment (NNRMS SC-B) were held to evaluate the new projects from financial and technical angles. Based on the recommendations of The Standing Committee of NNRMS SC-B, Eight new projects have been initiated/sanctioned during the period (Annexure-III). The Standing Committee of NNRMS SC-B in its meeting held on 10<sup>th</sup> February, 2009 recommended six new projects including two mega projects for funding. The Standing Committee also reviewed the recently

completed two mega projects (Annexure-IV) and suggested that the Final Technical Report (FTR) of the project should be submitted and placed before the Technical and Financial Sub-Committee of NNRMS SC-B for its perusal and acceptance.

Based on the results obtained and experience gained during the implementation of the project on "Monitoring of Snow and Glaciers in Himalayas" the Ministry of Environment & Forests has decided to continue the work on snow and glacier monitoring in the Himalaya and suggested that Space Applications Centre (SAC) take up this work in collaboration with all the organizations of the country working in this field. Accordingly, phase-II of the project has been prepared by the SAC, Ahmedabad for consideration by the Ministry. Under this project the Monitoring of seasonal snow cover for the entire Himalaya and Monitoring the retreat/advance of the glaciers in the representative basins will be taken up.

The Hon'ble MOS (I/C) E&F released the MoEF discussion paper on 'Himalayan Glaciers: A State-of-Art Review of Glacial Studies, Glacial Retreat and Climate Change' on 9th November, 2009, prepared by Shri V.K. Raina, Ex-Deputy Director General, Geological Survey of India (GSI)..

### Research on Wetlands, Mangroves and Coral Reefs

- Under National Wetland Conservation Programme during the year, Management Action Plan of twenty seven wetlands have been approved. Details about it are given at Chapter-2.
- The National Committee of Mangroves and Coral Reefs monitor the implementation of

the approved Management Action Plan for the Coastal States and UTs. The National Committee met on 29-30<sup>th</sup> September, 2009 at Andhra University, Vishakhapatnam and reviewed the Management Action Plans of Gujarat, Tamil Nadu, West Bengal, Orissa, Karnataka and Goa. The National Committee also discussed the significant research findings on ongoing projects on Mangroves and Coral Reefs.

### G.B. Pant Institute of Himalayan Environment and Development, Kosi-Katarmal, Almora

#### Introduction

G.B. Pant Institute of Himalayan Environment and Development (GBPIHED) was established in August 1988 by the Ministry of Environment and Forests, Government of India, as an autonomous Institute, with a mandate of achieving sustainable development and environmental conservation in the Indian Himalayan Region (IHR). The Institute executes its mandate through the Headquarters located at Kosi-Katarmal, Almora (Uttarakhand), and four regional Units located at Kullu (Himachal Pradesh), Srinagar-Garhwal (Uttarakhand), Pangthang (Sikkim) and Itanagar (Arunachal Pradesh). The Institute designs and implements R&D activities on priority environmental problems; develops and demonstrates best practices and delivers technology packages for improved livelihood options for the people of IHR. The identified thematic categories for Institute R&D activities include: (i) Watershed Processes and Management (WPM), (ii) Biodiversity Conservation and Management (BCM), (iii) Environmental Assessment and Management

(EAM), (iv) Socio-economic Development (SED), (v) Biotechnological Applications (BTA), and (vi) Knowledge Products and Capacity Building (KCB). The projects sites, spread over different parts of IHR, have been selected carefully keeping in view the biophysical heterogeneity and location-specific needs of the inhabitants. All activities are need-based, target-oriented and time-bound. Research, demonstration and dissemination are underlying elements of all project activities geared towards development of environment-friendly technology packages.

### Objectives

The Institute has three broad objectives:

- To undertake in-depth research and development studies on environmental problems of the Indian Himalayan Region;
- To identify and strengthen the local knowledge of the environment and contribute towards strengthening researches of regional relevance; and
- To evolve and demonstrate suitable technology packages and delivery systems for sustainable development of the region in harmony with local perceptions.

### Progress/Achievements made during the year

The achievements with wide range implications include the following:

- Contribution toward the development of a document for National Mission on Sustaining Himalayan Ecosystem; as desired by MoEF, the Institute prepared a draft Base Paper "Conservation of Himalayan Ecosystem and Adaptation/Regulation Measures" for the SEPM. The

base paper subsequently formed the basis of a joint publication of MoEF and GBPIHED "Governance for Sustaining Himalayan Ecosystem – G-SHE : Best Practices and Guidelines". The document was released by Hon'ble Minister of State (I/C), MoEF on 29.9.09.

- Institute has been designated as Technical Secretariat for the Himalayan Sustainable Development Forum (Shimla Declaration) based on Himalayan Chief Ministers' Conclave held in October, 2009 at Shimla.
- Institute contributed to the discussion paper on Himalayan Glaciers: A State-of-Art Review of Glacier Studies, Glacier Retreat & Climate Change published jointly with MoEF and released by Hon'ble Minister of State (I/C), MoEF on 09.11.09.
- A draft document for the Task Force of Planning Commission of India on critical issues related to hill states and hill areas was prepared.
- Based on the feasibility document prepared by the Institute, the Ministry has designated the Cold Desert Biosphere Reserve (CDBR) covering parts of Himachal Pradesh; on receipt of concurrence from the State Government, the relevant parts of J & K may be included in the CDBR.
- Through implementation of GOI-UNDP CCF-II project of Biodiversity Conservation through community based Natural Resource Management, the Institute mobilized tribal communities for participation in the conservation work in remote areas of Arunachal Pradesh.
- The Disaster Management faculty, Sikkim Unit of the Institute continued to act as

resource center for capacity building of various stakeholder groups in Sikkim.

- Through its Integrated Eco-development Research Programme, the Institute extended funding support to Universities, R&D Institutions, NGOs and others in the IHR to carry out time bound R&D projects supplementing the mandate of the Institute. During the year, support to eighteen on-going/completed projects was given.

### Research and Development Achievements

#### Socio Economic Development (SED) & Environmental Assessment and Management (EAM)

The group includes two themes; (i) Socio Economic Development (SED) which focuses on activities, such as livelihood enhancement, sustainable tourism, entrepreneurship and self employment, indigenous knowledge, and socio-economic and cultural implications, migration, etc; and (ii) Environmental Assessment and Management (EAM) targeting on activities such as hill specific Strategic Environmental Assessment (SEA), Environmental Impact Assessment (EIA), valuation of ecosystem services, climate change impacts, disaster mitigation and management, and environmental management of urban areas, etc.

#### Watershed Processes and Management (WPM) & Knowledge Products and Capacity Building (KCB)

Watershed Process and Management (WPM) and Knowledge Products and Capacity Building (KCB) are two major thematic thrusts of this group. Through its WPM

theme, group focuses on studies of ecosystem processes operational at the watershed level, including the involvement of user groups and upstream-downstream linkages, with an overall aim of strengthening of mountain specific resource management practices using a systems approach. The KCB theme of this group conducts activities that lead to enhancement of Institutional outreach, based on its research products such as state-of-the art methodologies/approaches, models and policy briefs, etc.

#### Biodiversity Conservation and Management (BCM) & Biotechnological Applications (BTA)

The group includes two thematic areas (i) Biodiversity Conservation and Management (BCM), and (ii) Biotechnological Applications (BTA); the aim is to ensure long term conservation of sensitive Himalayan biodiversity elements and improvement in the rural economy of the Indian Himalayan Region.

#### Application of R & D outputs in Demonstration and Dissemination

#### Capacity building through Rural Technology Center (RTC)

- A total of thirty two hill specific and environment friendly technologies those were demonstrated at the Rural Technology Center (Institute HQs) acted as live demonstrations for capacity building of six hundred fifty seven rural inhabitants (three hundred eighty male & two hundred seventy seven females).
- RTC organized three training programme for the farmers of three districts (Tehri Garhwal, Chamoli and Bageshwar) in



Uttarakhand under Livelihood improvement programme of Uttarakhand Parvatiya Aajeevika Sanvardhan Company (UPASaC). The programme resulted in capacity building of eighty progressive farmers, selected by UPASaC.

- Capacity building programmes were also organized for the farmers of eight villages in upper Kedar valley (Garhwal hills in Uttarakhand). The programmes focused on organic farming, off-seasonal vegetable cultivation, protected farming, bioprospecting/value addition, fish farming, mushroom cultivation, medicinal plant cultivation and entrepreneurship development.
- Training programmes were organized for senior and middle level officers for many of the State Government Departments (i.e., Irrigation & Flood control, Health & PHE, Building and Housing Department, UD & HD, Mines & Geology,

Forest Environment & Wildlife Management Department, Roads & Bridges, Geological Survey of India, DST, Border Road Organization, NGO, Police, etc.).

#### On site trainings and exposure

- On-site trainings and formal meetings were organized, covering over twenty nine villages, four Van Panchayat, three NGO groups and one hundred forty farmers in Uttarakhand. Also, a two-day on-site training programme on "Fodder production in community lands for livelihood enhancement" was organized for forty five stakeholders
- Seven days training programme on "Nature Science Activity Camp" was organized focusing on medicinal plants conservation. Over fifty participants representing students, teachers and NGOs of the Kullu valley participated.
- Towards promoting outreach through



Fig-34. Exposure visit on conservation and sustainable utilization of medicinal plants organised by GBPIHED

Conservation Education (CE), training workshop was organized at G.I.C. Matli, Uttarkashi. A total of one hundred six individuals (representing thirty schools) participated. Also, Under PROBE programme of DST, training programmes were organized for identified teachers and students of Himachal Pradesh (twenty schools) and Uttarakhand (twenty one schools).

### Strengthening of ICIMOD- India Programmes

The GBPIHED, which has been identified as nodal institute to represent Nodal Ministry MoEF for coordination and facilitation of implementation of ICIMOD-India programmes, made significant strides for strengthening the collaboration with ICIMOD. The major initiatives during the year include: (i) Organization of joint photo-exhibitions on 'Himalaya – Changing Landscape' at Kosi-Katarmal, Almora (September 10-12, 2009); Shimla (October 29-30, 2009); Mohal-Kullu (November 2-3, 2009); Srinagar, Garhwal (November 6-7, 2009); (ii) Extensive consultation and signing of LoA for implementation of 'Mt Kailash Sacred Landscape (KSL) Conservation Initiative project; (iii) Implementation of activities pertaining to small duration projects – 'Development of Baseline Information and Identification of Potential Corridors for Namdapha National Park (tiger reserve) and Mouling National Park (Arunachal Pradesh), and Assessment of Biodiversity Value and Ecosystem Services in the Protected Areas of Sikkim.

### Dissemination of Findings

Throughout the year, the R&D findings of the Institute were disseminated through

publication of research papers in scientific journals and magazines, popular articles and books and through Institute publications: Pt. G.B. Pant Memorial Lectures by eminent thinkers and scholars, Hima-Paryavaran (Biannual-Newsletter), ENVIS Bulletin, ENVIS Newsletter, Himalayan Biosphere Reserve Bulletin (Biannual) by Lead centre, and Annual Report.

### Budget Allocation of the Scheme during the year and Progress of Expenditure

An amount of Rs.1000.00 lakh was allocated for this scheme and of which Rs.739.35 lakh has been spent upto 18-01-2010.

### Forestry Research

#### Indian Council of Forestry Research and Education (ICFRE), Dehradun

Indian Council of Forestry Research and Education (ICFRE), an apex body in the national forestry research system, has been undertaking the holistic promotion of forestry research through need based planning, promoting, conducting and coordinating research, education and extension covering all aspects of forestry. The Council promotes

the solution based forestry research in tune with the emerging issues in the sector, including global concerns such as climate change, conservation of biological diversity, combating desertification and sustainable management and development of resources. Topical research by the Council enhances public confidence in the ability of forest managers and researchers to successfully handle challenges related to natural resource management.

### Objectives

- To undertake, aid, promote and coordinate forestry education, research and their applications.
- To develop and maintain a national library and information centre for forestry and allied sciences.
- To act as a collating-house for research and general information related to forests and wildlife.
- To develop forestry extension programmes and propagate the same through mass media, audio-visual aids and extension machinery.
- To provide consultancy services in the field of forestry research, education and allied sciences.
- To undertake other jobs considered necessary to attain these objectives.

### Institutes and Centres under the Council

ICFRE has eight Regional Research Institutes and four Research Centres located in different bio-geographical regions of the country to cater to the forestry research needs of the nation.

### Research Institutes under the Council are

- Forest Research Institute (FRI), Dehradun
- Institute of Forest Genetics and Tree Breeding (IFGTB), Coimbatore
- Institute of Wood Science and Technology (IWST), Bengaluru
- Tropical Forest Research Institute (TFRI), Jabalpur

- Rain Forest Research Institute (RFRI), Jorhat
- Arid Forest Research Institute (AFRI), Jodhpur
- Himalayan Forest Research Institute (HFRI), Shimla
- Institute of Forest Productivity (IFP), Ranchi

### Advanced Research Centres under the Council are

- Centre for Social Forestry and Eco-Rehabilitation (CSFER), Allahabad
- Centre for Forestry Research and Human Resource Development (CFRHRD), Chhindwara
- Forest Research Centre (FRC), Hyderabad
- Advanced Research Centre for Bamboo and Rattans (ARCBR), Aizawl

### Activities undertaken by the Council General

- Shri Jairam Ramesh Hon'ble Minister of State (Independent charge) for Environment & Forests, Government of India, visited ICFRE and FRI, Dehradun on 2<sup>nd</sup> June 2009 and reviewed the activities of ICFRE and discussed the issues of initiating All India Co-ordinated Project (AICP) in mining sector and strengthening of some of the Research Centres of the Council.
- ICFRE along with delegation of Government of India participated in the thirtieth session of the Subsidiary Body for Scientific and Technological Advice (SBSTA) and Subsidiary Body for Implementation (SBI), sixth session of AWG-LCA, and eighth session of AWG-KP at Bonn, Germany from 1st to 12th June.

- ICFRE as a part of Government of India delegation participated in the Climate Change talk held at Bonn, Germany from 10th to 14th August.
- ICFRE in Co-ordination with Coalition for Rainforest Nations (CfRN) organized a three day international workshop on “National Forest Inventory: The Experiences of Non-Annex I Countries” from 27<sup>th</sup> to 29<sup>th</sup> April 2009 at ICFRE, Dehradun. The workshop was attended by sixty one delegates from thirty two countries, and subject experts from six international organizations from GTZ, FAO, World Bank Forest Carbon Partnership Facility, EU JRC, CfRN, and Japan International Cooperation Agency.
- ICFRE concluded the ICFRE- ITTO project with a one - day wrap-up national seminar held on 26<sup>th</sup> June 2009. The project initiated on 1<sup>st</sup> July 2006, which was being implemented by the Division of Statistics, Directorate of Extension ICFRE. The seminar was held primarily to disseminate the

findings of the project including the new condensed database in compatible formats. A statement from the International Tropical Timber Organization (ITTO) was also read during the seminar in which the implementation of the project has been appreciated by the funding agency. The modalities of creating a Forestry Statistical System in the country based on the experiences in terms of terminology, methodology and technology was also discussed. The seminar was attended by thirty four participants from the State Forest Departments, Nodal Officers (Statistics) of ICFRE Institutes, other organizations like TIFAC, Kerala Forest Research Institute, National Sample Survey Organization, Forest Survey of India, etc.

### Institute-wise Development in the field of Research

#### Forest Research Institute (FRI), Dehradun

- Identification of four phenolic acids in heartwood of *Eucalyptus* hybrid derived



Fig-35. Participants of the International Workshop on 'National Forest Inventory: the experience of Non-Annex I countries at ICFRE, Dehradun

from *Eucalyptus citriodora* and *E.torelliana*.

- Identification of four accessions of *Acorus calamus* plant with less b –Asarone content useful for pharmaceutical industry
- Finding of aromatic oils having antifungal activity against fungal infestation of stored medicinal plant produce
- Assessments of pathogenicity of *Dreschlera* isolates (15) on G3 clone of *Populus deltoids*.

Designing species specific primers for quick identification of *Cordyceps sinensis*.

- Under the “Digitization of FRI Herbarium” programme, 544 species details and 2992 herbarium label data cards were prepared. In all 2435 specimens were digitized of which 2024 were edited for uploading in the database.

#### Arid Forest Research Institute (AFRI), Jodhpur

- It was observed that soils of Sri Ganganagar district are mainly old alluvial covered with aeolian deposits of varying sizes supporting desert dune scrub type of vegetation. The vegetation like *Leptadenia pyrotechnica* and *Haloxylon salicornicum* penetrated their root up to soil depth of 190 and 160 cm, respectively. There was no characteristic soil horizon development signifying the nature of Entisols. At some places gypsum deposition observed at shallow depth. In another study *Salvadora persica* proved to be the most hardy plant surviving extremely harsh conditions of high salinity, heat stress and drought followed by *Acacia bivenosa* with 3 to 11% decrease

in survival. Sprouting was observed in plants of *Acacia ampliceps* which were scorched due to salt laden hot winds from rann side. The plants of *Acacia ampliceps* were scorched due to salt laden hot winds from rann side. Damage is extensive and occurred around 26-28 May 09. Some new leaves were observed. Damage was less in case of *Acacia bivenosa* and negligible in case of *Salvadora persica*. Deposition of salty soil was observed on all the plants in and around the experimental area.

- From the pulverized twigs of *Commiphora wightii* (Pre & post ethephone treatment in 07-08) soxhlet was extracted with petroleum ether and ethyl acetate. The petroleum ether contents was 1.7 to 1.9 % in the pre ethephone treated plants. While EtOAc content was ranging from 0.69-1.52%. There is increase in secondary metabolite contents after ethephone treatment and it was ranging from 1.9 to 3.3% and 1.4 to 2.25% for petroleum ether and EtOAc fractions.
- Under the project “Enhancing Productivity of Saline Wastelands in Kachchh, through Improved Tree Planting Techniques and Silvopastoral Study” annual growth measurement in silvipastoral trials at Bhuj were revealed. Based on mean height and crown diameter, above ground biomass estimation was done for *Zyziphus mauritiana* and *Cordia gharaf* in control and with grass treatments. Fresh weight was determined in field. Green grass yield was estimated for *Cenchrus ciliaris* and *C. setigerus*.
- The study revealed *Salvadora persica* (92%), and *Acacia bivenosa* (84%) to be

the hardiest plants surviving the extremely harsh conditions of high salinity, heat stress and drought conditions on silty clay black medium depth soil after twenty four months of establishment. *Acacia ampliceps* (50%) showed revival and has the potential to perform.

**Institute of Forest Genetics and Tree Breeding (IFGTB), Coimbatore**

- *Phyllanthus acidus* was observed for antioxidant activity. Reducing power assay method revealed that fruits collected from Chidambaram showed rich activity of antioxidant activity (48.15%) followed by Dharmaburi (47.27%), Palani (46.31%), Thirumangalam (45.08%), Thanjavur (43.81%), Coimbatore (43.02%) and Kanyakumari (42.40%).
- Inoculation of artificially cultured *Frankia* (actinomycete) strain isolated from *Casuarina junghuhniana* to the seedlings of *C. junghuhniana* at early seedling stage (fourteen days). After twenty one days of inoculation the young seedlings in the mother bed showed root nodule formation, which are nitrogen fixing sites, are rarely found in the young seedlings. These root nodules enhance the growth of *C. junghuhniana* during seedling stage.
- Assessed the efficacy of crude secondary plant derivatives of *Aegle marmelos* and its seed oil on important insect pests of teak seedlings at nursery stage, Valluvasery, Nilambur (North), Kerala. The preliminary observation revealed that the individual bioactive compounds present in *Aegle marmelos* were very effective against the teak defoliator and nematode at nursery stage.

- Developed a modified simple protocol for estimation of carbonic anhydrase activity. In general, different assay methods, namely, manometric, colorimetric and electrometric are in use for the assay of carbonic anhydrase. The activity of carbonic anhydrase are measured by titrimetry, where the titration of H<sup>+</sup> ions produced in a titration reaction and the variations in pH were detected using a titration indicator. The comparisons of methods with the titration modified procedure shows that it offers a satisfactory alternative to the usual electrometric method to achieve the same standard of precision.

**Institute of Wood Science and Technology (IWST), Bangalore**

- The project- “Productivity and interaction studies in *Acacia* Hybrid based Agroforestry practices in Karnataka” was completed.
- The project on “Assessment of seed quality in unimproved populations, seed production areas and seed orchards of *Tectona grandis*” was concluded. The study reveals the importance of SPA resource of “quality seeds”, based on morphological characters and seed germination fruits collected from all Teak SPAs, has better quality as compared to unimproved populations.

**Tropical Forest Research Institute (TFRI), Jabalpur**

- The detailed field observations revealed that the white grubs, *Holotrichia rustica*, *H. mucida* and *Schizonycha ruficollis* were recorded as pest on teak seedlings for the first time. Studies were undertaken for developing effective Integrated Pest Management (IPM) of this pest. It was

observed that there has been an increase in the incidence of *Holotrichia* and *Schizonycha* white grub species mainly on teak (*Tectona grandis*), due to the increased seedling production in forest nurseries. At Ramdongari Forest Nursery, FDCM, Nagpur, the damage incidence may go up to fifty two percent. The developed IPM package included hand-picking of grubs as a mechanical option along with trap-kill method, followed by treatments in the nursery beds in judicious combination of chemicals and biological control agents. This practice proved to be successful in management of the white grub population in the nursery.

#### Rain Forest Research Institute (RFRI), Jorhat

- Maintenance and gap filling of field trials of *B. balcooa*, *B. bambos* and *D. hamiltonii* at trial sites in Arunachal Pradesh, Assam, Nagaland and Tripura was done. Data collection for growth parameters of bamboo in different treatments and yield estimation of intercrop for the year is under progress under the project-“Development of Suitable Agro-forestry Models for Promoting Bamboo Cultivation Outside Forests in Northeast Region”.
- RFRI, Jorhat completed digitization of soil type map of Nagaland under the project “Establishment of GIS laboratory for systematic creation, management and up-gradation of GIS based forest-database of North-east India”.
- Under the project “On-farm innovation in macro-proliferation technique and promotion for commercial plantation of edible bamboo shoot species” growth and

yield data on bamboo intercropping trial were recorded.

- Seedlings of *Calamus namborensis* were collected from Risakthepei area of Nambor RF and planted at Botanical garden of RFRI, Jorhat under the project “Assessment of Rattan Diversity and Conservation Strategy with Reference to Assam”.

#### Himalayan Forest Research Institute, Shimla

- *Alnus nitida* besides *Quercus leucotrichophora* – has been identified as another natural host for Indian Gypsy Moth in Kullu Valley.

#### Institute of Forest Productivity, Ranchi

- The institute has identified species specific molecular markers (RAPD) for eastern Indian bamboo species visually, *Bambusa balcooa*, *B. bambos*, *B.tulda*, *B.nutans* and *Dendrocalamus strictus* (shown as A, B, C, D and E respectively in the figure below). The markers have resolved the problem of taxonomic identification of closely resembling bamboo species especially *B. tulda* and *B. nutans*. Molecular characterization of superior accessions of *Jatropha curcas* and clonal fidelity studies in tissue culture raised plantlets have also been carried out successfully.

#### Extension activities by ICFRE and its Institutes

- International Day of Biodiversity was celebrated at FRI, Dehradun, TFRI, Jabalpur HFRI, Shimla, IWST, Bangalore, AFRI, Jodhpur and IFP Ranchi on 22<sup>nd</sup> May 2009. Various activities including talk on “Biodiversity and Invasive Alien Species” at IWST, Bangalore; planting neem trees

at AFRI, Jodhpur and a workshop on Invasive Alien Species (IAS) at IFP, Ranchi were undertaken.

- FRI, Dehradun, IWST, Bangalore, IFGTB, Coimbatore, AFRI, Jodhpur and IFP, Ranchi celebrated the World Environment Day, 2009 on 5<sup>th</sup> June 2009. The theme of the celebration was “Your Planet Needs You – Unite to Combat Climate Change”. As part of the celebrations, the institutes organized a commemorative tree planting programme. AFRI, Jodhpur released leaflet containing research highlights of the institute, in Hindi, on this occasion.
- AFRI, Jodhpur celebrated World Day to Combat Desertification on 17<sup>th</sup> June 2009 by planting of *Commiphora wightii* (Guggul) Sh. Malkhan Singh, Hon’ble MLA, of Luni constituency was the chief guest and Sh. Rahul Parashar, Councillor, Sardarpura, Jodhpur was the Guest of Honour on this occasion. Leaflets and pamphlets on “Desertification: Challenges and Strategies for Control” were released by the dignitaries. A presentation on Draught and Desertification was also made by Dr. G.Singh, Scientist-E of AFRI
- The World Earth Day was observed at IFGTB, Coimbatore on 22<sup>nd</sup> April 2009. The Officers, Scientists and staff of the institute participated in a *shramdhan* and cleaned the campus premises.
- FRI, Dehradun celebrated the “National Technology Day’ on 11<sup>th</sup> May 2009 by allowing free entry to all six museums for the visitors.
- FRI, Dehradun organized International Symposium on “Multi-Purpose Forestry: Managing and Enhancing Ecosystem

Services and Production of Forests, Woodlands and Trees Outside Forests” from 9<sup>th</sup> to 13<sup>th</sup> November 2009.

- AFRI, Jodhpur and Indian Institute of forest Management, Bhopal jointly organized one-day Consultative Workshop on “Development of Criteria and Indicators for Sustainable NTFP Management” on 29<sup>th</sup> August, 2009, at AFRI, Jodhpur. The main objective of the workshop was to provide a forum for linking various agencies, institutions and stakeholders dealing with dry and arid NTFP species and their ecological systems and to share experiences and knowledge, related to the development of C & I

### Consultancies undertaken by ICFRE and its Institutes

- The Environmental Impact Assessment (EIA) Division under the Directorate of Extension, ICFRE, Dehradun successfully completed Environmental Impact Assessment studies and formulated Environmental Management Plan of the Kotlibhel Hydro electric project stage-II (KHEP) for National Hydro Power Corporation Ltd (NHPC). As per the requirement of the PCCF, Uttarakhand a supplementary study on the downstream micro- watersheds was taken up for identification of potential habitat for restoration of identified micro-watershed to facilitate the *Tor putitora*, the important cold water migratory fish, in the rivers Bhagirathi and Ganga. Also, as desired by the Forest Advisory Committee (FAC), Ministry of Environment and Forests, Government of India, a joint presentation in collaboration with H N B Garhwal University Srinagar (Garhwal), Uttarakhand, was made to appraise the committee on the project based



impact for KHEB –1A, KHEB-1B and KHEB stage –II to be implemented by NHPC on the environment of the area.

- ICFRE, Dehradun, IFGTB, Coimbatore, FRI, Dehradun and IWST, Bangalore undertook field visit to Bhutan and North Bengal for the baseline study on fauna and flora from 11<sup>th</sup> to 21<sup>st</sup> May 2009 for Bunakha Multipurpose Hydroelectric project for updation of DPR and Environmental Impact Assessment and Environmental Management Plan for Sankosh Multipurpose Hydroelectric project, Bhutan.
- FRI, Dehradun provided consultancy on “Development of Bambusetum” at Garhi Mandu in National Capital Territory, Delhi funded by Govt. of Delhi.
- FRI, Dehradun provided consultancy on “Development of potted plants for NCT of Delhi” funded by Govt. of Delhi.
- FRI, Dehradun provided consultancy on preparation of works manual on NREGA funded by UNDP.
- Govt. of NCT of Delhi awarded FRI, Dehradun a consultancy on preparation of the Management Plan of Asola Bhatti Wildlife Sanctuary, New Delhi

### **Indian Institute of Forest Management (IIFM), Bhopal**

The Institute, as a sectoral management institute, imparts education in forest management, which is a judicious mixture of forestry, social, and management science. The Institute constantly endeavours to keep in touch with the problems of people, especially the forest dwellers and undertakes need-based research. The Institute tries to serve as a reservoir of knowledge in the area of forest

management and ensures proper integration of external and indigenous knowledge suitable to Indian context.

The specific objectives of the Institute are:

#### **Education and Training**

- To meet the demand for the trained human resource with managerial and analytical skills in the areas of forestry, environment and development management through regular educational courses.
- To update the knowledge and managerial skills of the serving professionals in the above areas through short-term training Programs.

#### **Research and Consultancy**

- To generate information on field realities and derive meaningful interpretation through systematic research.
- To offer consultancy services to the client organizations based on the available expertise.

#### **Dissemination**

- To disseminate the research-based information/knowledge and meet the information needs of the forestry, environment and allied sectors through training, seminars and publications.

#### **Databases and Information Systems**

- To generate and maintain relevant databases that are essential for policy formulation, project planning and strategy development in forestry, environment and allied sectors
- To develop an Information Management System, which is compatible with and easily

accessible for all users, i.e. from local (community) to global level.

### Policy Formulation, Analysis and Advocacy

- To function as a national ‘think tank’ on forestry and environment aimed at developing appropriate policies and strategies.
- To play an advocacy role in the sectors of concern to promote adoption of appropriate policies and implementation strategies and safeguard the genuine interests of the disadvantaged stakeholders whenever necessary without compromising national interests.

### Research

- Research is one of the key activities of the Institute. As a management institute in the forestry sector, research activities of applied nature receive attention in the Institute. Drawing on the strength of diversified faculty, the institute promotes research projects of multidisciplinary nature. Some of the key research areas include Sustainable Forest Management, Management of Non-wood Forest Produce, Joint Forest Management and Community Forestry, Protected Areas and People, Marketing of NWFP and MIS, Forest Grazing and Livelihoods, Remote Sensing and GIS application in Forestry etc. Various central and state government departments like Ministry of Environment and Forests, Department of Science and Technology, State Forest departments, etc. have funded the research projects at IIFM. Some research projects have been funded by the international organizations like International Tropical Timber Organization, Food and

Agriculture Organization of United Nations, etc. A total of seventeen research studies are ongoing, whereas eight studies were completed by the Institute during the year.

### Centres of Excellence in ICFRE

#### International Centre for Community Forestry (ICCF)

The International Centre for Community Forestry (ICCF) is functioning as a “Centre of Excellence” to cater to the growing need and interest in Community Forestry (CF) initiatives. It aims to promote community forestry initiatives and publications in the field of Joint Forest Management (JFM), Self-Initiated Forest Protection (SIFP) and other forms of community based forest management system.

The Centre began functioning actively in 2001, with fund support from the Sir Dorabji Tata Trust (SDTT), Mumbai. Later, it received many projects from various governments and non government agencies through which the Centre catered its other ongoing community forestry projects. The centre publishes a newsletter “People and Forests” based on its activities for dissemination of information to rest of the world.

The ICCF envisages programs implementation involving exchange of scientists, researchers and community forestry workers from India and other countries.

#### Center for Ecological Services Management (CESM)

The Center for Ecological Services Management (CESM) is being set up as an interdisciplinary center to address crucial policy issues associated with the complex relationship between ecological, social,

economic, legal and institutional aspects of ecosystem management. The center has the mandate to undertake research, consultancy, teaching, training activities as well as prepare data base on the values of ecosystem services, develop and standardize techniques of valuation of ecosystem service and impact studies of degradation. It would also network with national and international organizations in the Natural Resource Management (NRM) sector for promoting professional exchange.

Currently two projects are being housed under the center (i) CNRM Institutions and Poverty Reduction in Gujarat And Madhya Pradesh" funded by Shastri Millennium Development Goals Research Grant (2009-2010) with focus on the poverty reduction possibilities for village communities of the new decentralized Participatory Irrigation Management, Joint Forest Management, participatory watershed management and fisheries cooperatives. The project is executed by the UBC, Canada, GIDR & DSC, Ahmedabad & IIFM, Bhopal; and (ii) Strengthening Capacity to Alleviate Poverty through Ecosystem Services (SCAPES) – Putting Methodological Development into Practice in India" (2008-2009) with the support of NERC and DFID, UK & UNEP, Kenya. The project is implemented through the Consortium of organizations comprising of SWIMMER, U.K. – the coordinating institution and University of Cambridge University of Oxford, UNEP's Ecosystem Economics Research Unit in Nairobi, IIFM, Bhopal; ATREE, Bangalore; GIDR, Ahmedabad; NEHU, Shillong; CISED, Bangalore; Winrock International India, Gurgaon; CHIRAG and PSI, Dehradun as core partners.

### Center for Sustainable Forest Management & Forest Certification (SFM & FC)

Forest Certification has emerged as an important market driven tool and a mechanism for assessment and monitoring of forest and forest products. It is a process that leads to the issuing of a certificate by an independent party, which verifies that an area of forest is managed to a defined standard.

The center for SFM & FC represents IIFM as member in both the National Working Group as well as the National Forest Certification Committee, constituted by Govt. of India.

The center is expected to generate the pool of knowledge and understanding on the emerging field of Sustainable Forest Management & Forest Certification for the benefit of forestry sector in the country.

### Regional Center for National Afforestation and Eco-development Board (RCNAEB)

The Regional Center for National Afforestation and Eco-development Board, (RCNAEB), was established in 1989 at Indian Institute of Forest Management, Bhopal, which is one out of seven in the country. The center looks after the States of Madhya Pradesh, Chhatisgarh and Orissa in pursuing the programmes of National Afforestation and Eco-development Board (NAEB), Ministry of Environment and Forests (MOEF), Govt. of India, New Delhi. Monitoring and evaluation of plantations raised by forest departments/ NGO's is done through this center. Apart from MoU between MoEF & IIFM, an Advisory Management Committee and a Core Group of faculty members guide the functioning of

the center. So far the center has organized and co-ordinated several training programmes, research projects, evaluation of plantation works done by forest departments and NGOs, plantation assessment for Indira Priyadarshini Vriksha Mitra (IPVM) award.

### Indian Plywood Industries Research and Training Institute (IPIRTI), Bengaluru

Established in 1962 as a co-operative research laboratory at the initiative of the Indian Plywood Industry with participation of the Council of Scientific and Industrial Research, Indian Plywood Industries Research and Training Institute (IPIRTI) is now an autonomous Research and Training Institute

under the Ministry of Environment & Forests, Government of India. From the inception, the Institute has been closely associated with development of plywood and panel industry in the country and also instrumental in the growth, from its infant stage. The Institute remains an industry driven organization. Recognized (since 1989) as a Scientific & Industrial Research Organization by the Government of India under the Department of Scientific and Industrial Research Scheme.

The Institute is basically mandated to carry out research and development, training and education, testing and standardization and extension in the field of plywood and panel product manufacturing. The multidisciplinary research projects based on the problems identified by the industrial representatives, Institute Scientists and other similar interested organizations, are taken up.

This is the only Institute of its kind in the country working for the plywood and panel industries. Due to expertise and credibility established over many years, the Institute has developed a strong relationship with the industry and well recognized for its contribution. As a result, industry continues to support our research efforts. An important and unique aspect of R & D works at the Institute is that lab scale findings are upscaled to industrial level to facilitate their adoption by the Industries.

#### Recent Research activities at ICFRE

##### Reconstituted Face Veneer

A technology for the production of face veneers using small girth plantation timbers has been developed at IPIRTI. At present, imported timbers like Keruing/Gurjan are peeled to make 0.23 to 0.28 mm thick face



Fig-36. Face veneer produced from reconstituted flitch.

veneers for making plywood, due to non-availability of traditional Indian hardwoods. The face veneer constitute about 20% of total timber requirement of plywood and import of face veneers at present, is to the tune of Rs.8000 Crores. The sources of supply of these imported species are getting depleted drastically, day by day. Hence this technology of making face veneers will facilitate to meet the challenges posed by the shortage of face quality veneers.

### Life Cycle Assessment of Wood and Bamboo Composites

Another important research project undertaken by the Institute is "Life Cycle Assessment of Wood and Bamboo Composites" as the bamboo and plantation wood based products are biodegradable and hence the life span study is a vital necessity for these new generation products. This will also facilitate to study the environmental burden associated with manufacturing of panel products from resource extraction to end of life.

### Bio-adhesives

Phenol formaldehyde and urea formaldehyde are two major synthetic resin polymers used widely for the manufacture of wood and lignocellulose based panel products. Dwindling supply of phenol and ever increasing cost has led to search for material of natural origin to replace phenol in phenol formaldehyde resin. A number of natural materials are available which have, in their molecular architecture, units resembling phenol and are capable of undergoing reactions similar to phenol. Due to their natural origin, these are available on a renewable and sustainable basis and

thereby will help in avoiding continued dependence on petroleum resources. Natural materials such as Cashew Nut Shell Liquid (CNSL), Tannin, Lignin, etc., have been tried as a substitute for phenol in the development of PF for panel products.

Tannin is bark extract mostly used for converting skin into leather. Tannin contains phenolic unit which react with formaldehyde to polymerize into resin. Mimosa wattle tannin has been used in preparation of tannin formaldehyde resin for making particle board and also plywood. But large scale success in the field of plywood adhesive has not been reported. For the present work mimosa wattle tannin was used as an extender with phenol formaldehyde resin for manufacture of plywood for i) making a cheaper adhesive, ii) making plywood with veneer having higher moisture content than normal and thus lowering energy requirement for drying. In no case the quality of plywood is compromised.

### Wildlife Institute of India (WII), Dehradun

Wildlife Institute of India (WII) is a premier training and research institution in the field of wildlife and protected area



Fig-37. Red Headed Crane



## Ministry of Environment & Forests

---

management in South Asia. Wildlife research at the Institute covers ecological, biological, socio-economic and managerial aspects of wildlife conservation. The research project generates valuable academic data, help evolve study techniques relevant to the Indian ground conditions and also create a group of trained field biologists, socio-economists and wildlife managers. The scientific information generated is utilized for management of protected areas. Research also enables the institute's faculty to keep

abreast of the current field situations, management needs and research trends in the field and thus constantly enhance its professional skill and update its teaching inputs.

During the reporting period thirty two research projects were ongoing in the Institute. The following research publications were brought out by the Institute during the reporting period: (i) Research Outcomes (1995-2009); and (ii) India's Green Book (Forests & Wildlife).

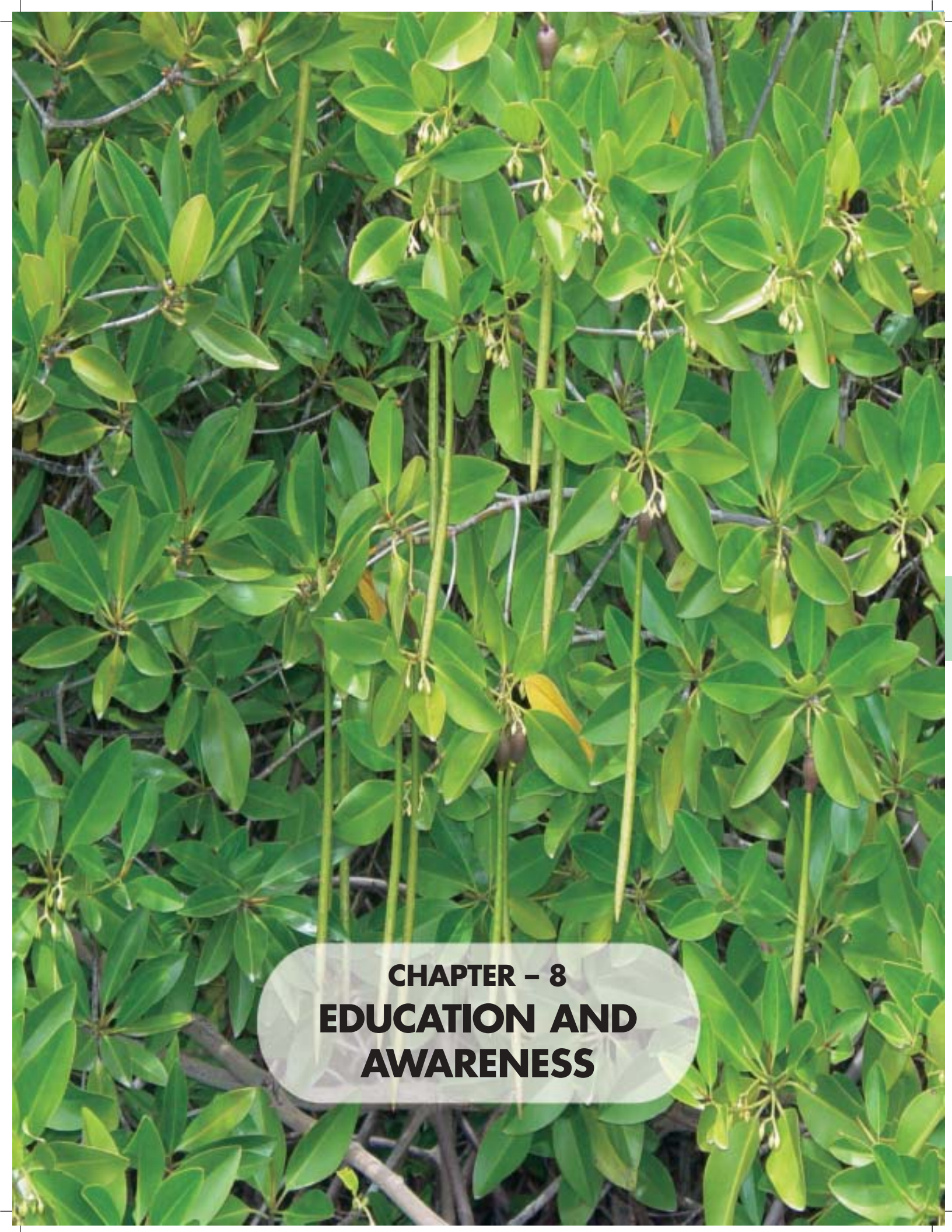
A photograph of a mangrove forest. The image shows a dense canopy of green, oval-shaped leaves. Several prominent, thick, light-colored prop roots (rhizomes) extend vertically from the branches down towards the ground. The background is filled with more foliage, creating a lush, textured appearance.

**CHAPTER – 8**  
**EDUCATION AND**  
**AWARENESS**

## Environmental Education, Awareness and Training

### Introduction and Objectives

The emergence of environmental issues at the top of the global agenda in the context of climate change concerns underline the need for collective endeavour for protection of environment. This warrants informed and voluntary participation of all sections of the people in the movement for conservation and participation of environment. Awareness of people about emerging environmental issues and the interconnections between the life styles and environment is an essential prerequisite for such participation.

Population increase, rapid urbanisation and industrialisation, increasing needs of energy etc., have impacted the availability of natural resources besides denting the quality of environment. The environmental damage already inflicted cannot be reversed unless there is collective thinking, will and effort. These call for public awareness and participation for bringing about an attitudinal change and finally restricting further damage to the environment. Effective implementation of environmental management and conservation programmes depends on education, awareness raising and training in the relevant areas. Without an adequate awareness of the impending challenges and their implications, few people would be motivated to participate actively in programmes on environmental conservation. Environment education and awareness thus assumes critical importance.

The 'Environmental Education, Awareness and Training' is a flagship scheme

of the Ministry for enhancing the understanding of people at all levels about the relationship between human beings and the environment and to develop capabilities/skills to improve and protect the environment. This scheme was launched in 1983-84 with the following basic objectives:

- To develop educational/teaching materials and aids in the formal education sector;
- To encourage non-governmental organizations, mass media and other concerned organizations for promoting environmental awareness among the people at all levels;
- To promote environment education through existing educational/scientific /research institutions;
- To ensure training and man-power development in environment education; and
- To mobilize people's participation in the conservation and protection of environment

### Activities undertaken during the year

The major programmes undertaken to achieve the overall objectives of the scheme are as follows:

### National Green Corps (NGC) Programme

It is a well established and recognised fact that the children can be catalysts in promoting a mass movement about the ensemble of the environmental issues. Being future citizens, inculcation of environment friendly attitudes and behavioural patterns amongst them can make a significant difference to the long term efforts for protection of environment. Children are triggers for a chain reaction, making a difference at the



local and community level which in due course lead to awareness at village, city, State, country and global level. MoEF has hence, embarked upon a major initiative for creating environmental awareness among children by launching National Green Corps (NGC) in 2001-02. In less than nine years, that the programme has been in operation, it has been catapulted into a mass movement of children for maintaining and preserving the environment. 1,12,844 Eco-clubs have so far been established in NGC Schools across the country.

During financial year 2009-10 (as on 23.02.2010), 87,117 Eco-clubs were supported by the Ministry across the country.

A country wide training programme for Teachers-in-charge of Eco-clubs initiated during 2007-08 was continued during the year at a cost of Rs. 0.90 Crores. A total of 12,000 Teachers-in-charge of Eco-clubs have been trained during the year.

### National Environment Awareness Campaign (NEAC)

The need for a mass movement for protection of environment needs no emphasis. The concerns of the people for environment need to be harnessed into voluntary action. This requires a network of nodal agencies and grass-root level organisations.

The NEAC was launched in mid 1986 with the objective of creating environmental awareness at the national level. In this

campaign, nominal financial assistance is provided to NGOs, schools, colleges, universities, research institutes, women and youth organisations, army units, government departments etc. from all over the country for conducting awareness raising and action oriented activities. The awareness activities could be seminars, workshops, training programmes, camps, padyatras, rallies,



Fig-38. 'Conserve your Environment' - conveyed by these Eco-club members

public meetings, exhibitions, essay/debate/painting/poster competitions, folk dances and songs, street theatre, puppet shows, preparation and distribution of environmental education resource materials etc. Action components could be plantation of trees, management of household waste, cleaning of water bodies, taking up water harvesting structures, use of energy saving devices etc. Diverse target groups encompassing students, youths, teachers, tribals, farmers, other rural population, professionals and the general public are covered under NEAC. The

programme is implemented through designated Regional Resource Agencies (RRAs) appointed for specific States/Regions of the country. (Annexure-IX)

This programme was continued during 2009-10 with 'Climate Change' as the theme. The following sub- themes for action components were considered for financial assistance

- (i) Plantation Programme,
- (ii) Use of wind and solar energy i.e. solar cookers and solar heaters,
- (iii) Restoration and maintenance of water bodies,
- (iv) Wetland conservation,
- (v) Solid waste management and composting/vermi-composting,

Thirty three Regional Resource Agencies (RRAs) appointed by the Ministry are involved in conducting, supervising and monitoring the NEAC activities during the year. A total of 11,738 organisations have been involved in the campaign across the country. The Ministry released a grant of Rs.8.40 Cr to the RRAs for further disbursement among the approved participating organizations.

### Library



The Library is the documented repository of the Ministry for dissemination of information in the field of environment and its associated areas. It has a collection of over 25,000 books and Technical reports etc. Besides, the library also receives more than fifty four national/international journals covering diverse areas of environment. Being the scientific Ministry, Library is one of the

richest documentary bases for scientific journals in the field of environment and its associated areas.

The library performs an important role in the planning, promotion, implementation and coordination of the Ministry's objectives by providing timely access to relevant and comprehensive information to its users-officials of the Ministry, external organizations (both governmental and non governmental), research students, decision makers etc.

Research scholars from various organisations, institutions and other professional bodies visited the library for a variety of information required by them from time to time.

### Seminars/Symposia/Workshops

This programme provides a platform to scientists/environmentalists/ University professionals/ technocrats, etc, to share their knowledge on various subjects related to environment. The Ministry provides financial assistance to the Universities/other institutions/NGOs to organise events (seminars /Symposia/Workshops/ Conferences) and to publish the proceedings. The scheme facilitates the transfer of technical know-how to different people including local population.

Universities/Professional bodies/ Technical Institutions and other R&D organisations are very responsive to the programme as is evidenced by the increase in the number of proposals being received by the Ministry. Thrust areas as identified under the programme are under constant review and being expanded to include more new areas. During the financial year 2009-10 (as on 23.02.2010) forty organisations

were provided financial assistance for conducting seminars/symposia/workshops etc.

### Mass Awareness

Media Cell of the Ministry is mandated with taking up awareness campaigns using print and electronic media besides other mass media to enhance awareness about various environmental issues which would in turn facilitate better compliance with environment regulations. Media Cell is guided by an Advisory Committee of Experts on Media Matters under the Chairmanship of Secretary(E&F) in this regard.

During the year, as per the Media Action Plan (MAP), adopted by the Ministry, the following major activities were supported/ sponsored/ completed:

- The biennial Competitive CMS Vatavaran Film Festival was held in New Delhi during October 27-31, 2009 in association with the Centre for Media Studies, New Delhi.
- The World Environment Day(WED) was commemorated on 5th June 2009 on the theme: 'The Planet Needs You! Respond to Climate Change'. The occasion was graced by the Hon'ble President of India.
- 26 episodes each of two sponsored radio programmes viz., 'Koshish Sunehare Kal Ki' and 'Fantastic Four' on environmental issues were commissioned for weekly broadcast over All India Radio.
- Production of 13 episode docu-drama on biodiversity, afforestation, pollution and climate change for T.V. telecast was completed. Production of a film on 'Man-Animal Conflict' was also completed.

- Production of short duration T.V. spots on biodiversity, climate change, use of plastics, pollution, afforestation and environment friendly lifestyles was commissioned during the year for effective mass awareness campaign on television media

### Environment Appreciation Courses

In order to provide interested persons an opportunity to learn in detail about specific environmental issues, the Ministry facilitates provision of a course module through Indira Gandhi National Open University (IGNOU) for Environment Appreciation Courses. Delivery of these courses is through distance education mode. The course module developed for appreciation courses is also being used by the IGNOU as compulsory component of its undergraduate courses. This is in pursuance of the directives of the Hon'ble Supreme Court of India.

### Grants-in-Aid to Professional Societies and Institutions

The objective of this programme is to facilitate optimum utilization of expertise available with professional societies and institutions for promotion of environment education and awareness. The programme aims at utilizing the existing capacity while simultaneously providing for enhancing the capacities of such institutions. The project to be financially supported would *inter-alia* include development/extension of exhibition galleries, interpretation centres and education materials relating to ecology, wildlife and environment. The financial assistance is not provided for procurement of capital goods/ equipment. However, some office equipment like computer, projector etc can be purchased if they are incidental to or essential part of

exhibition galleries, interpretation centres and educational focused activities. This one time grant is also not available for research, collection and compilation of data and information or to any individual/business houses.

### Publication of resource material related to environment

The objective of this programme is to utilize expertise available with professional societies, voluntary organizations etc. for developing and publication of innovative and high quality resource material for promoting environmental education and awareness by providing financial assistance for development and publication of such material. The publication material must popularize the understanding about the environment, emerging issues and out of the box solutions including innovative approaches for protection and should be relevant and of high standards and should supplement the efforts of the Ministry to promote environment education and awareness.

Under the programme, grant is not provided for publication of newsletters, magazines, journals, periodicals etc. or to any publisher/business house including individuals.

### Global Learning and Observations to Benefit the Environment (GLOBE)

The Global Learning and Observations to Benefit the Environment (GLOBE) Programme – an international Science and Education programme – provides a unique opportunity to the school students to carry out various measurements so that they can learn about scientific protocols and perform

environmental learning activities, which have already been introduced as theory in the textbooks. The GLOBE programme not only helps the students to appreciate the contents of the textbooks through better understanding but also assists them in gaining complete knowledge of environment.

It facilitates research through a worldwide research team comprising of students, teachers and scientists.

A process to further consolidate the activities under the GLOBE programme in all the 1800 schools started in the financial year 2006-07 were intensified during the year. Two training programmes to train new teachers in GLOBE protocols were conducted.

### Other Awareness Programmes

Since the financial assistance provided for awareness programmes under the NEAC is for activities to be conducted in a specific time frame and are short-term projects restricted to a specific area, other proposals for creating awareness among diverse target groups are received throughout the year from various NGOs and other agencies. These are considered on merit as and when received and supported. Some of the major awareness activities conducted/sponsored during the year are mentioned below:

- Observance of Earth Day: Earth Day is observed on April 22 every year to increase public awareness on the environment. During the year, a host of activities were supported on the occasion to involve people in making a difference to the understanding of environment. The activities ranged from

competitions (essay, painting, poster making, etc.) to rallies, runs, formation of human chain etc. Street plays were also organised to spread the message of environment conservation.

- Green Olympiad 2009 and TERRA Quiz
  - The Ministry sponsored the National Written Environmental Quiz programme organised by The Energy and Resource Institute (TERI). The winners from each region participated in the televised Quiz titled "TERRA Quiz".
- Vacation Programme on Natural Resources
  - A four weeks residential programme on Natural Resources involving children from Karnal (Haryana) was sponsored.
- Perfect Health Mela-2009 – An Inter Eco-club Schools Completion involving students from schools in Delhi and NCR was sponsored as part of Perfect Health Mela-2009.

#### Progress/Achievements made during the year

- 87,117 Eco-clubs supported during 2009-10 (as on 23.02.2010).
- 12,000 Teachers-in-charge of Eco-clubs trained.
- Record level of financial assistance of Rs. 8.40 Cr. released under NEAC.
- Numbers of participating organisations in NEAC reached an all time high of 11,738

#### Comparison of progress during the year

Progress mode in supporting Eco-clubs under NGC since 2003-04 is shown in Fig.-39.

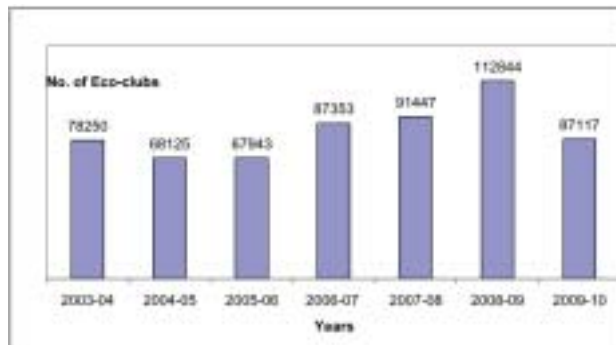

Note: 2009-10 (as on 23.02.2010)

Fig.-39. Progress mode in supporting National Green Corps (NGC)

The number of participating organisations in NEAC rose from 115 during 1986-87 to 11,738 during 2009-10. (Fig.-40)

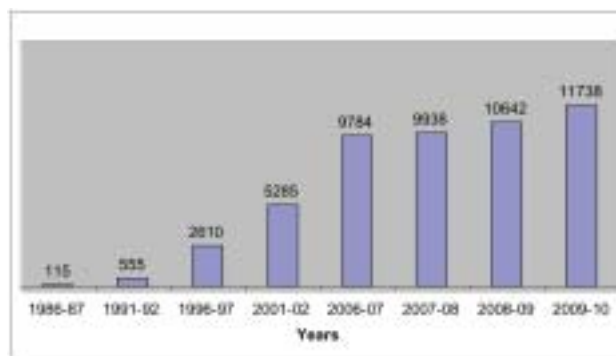

Fig.-40. Participating organizations in National Environment Awareness Campaign (NEAC)

#### State-wise status:

- Number of eco-clubs established in States/UTs since 2003-04 is given in Table-27.
- Amount sanctioned under NEAC programme since 2003-04 is given in Table-28.

#### Implementing organisations along with details

The National Green Corps Programme is implemented throughout the country through State Nodal Agencies. A list of nodal agencies

## Ministry of Environment & Forests

in States / UTs is at Annexure-VIII. The Regional Resource Agencies help the Ministry in conducting, supervising and monitoring the NEAC activities throughout the country.

**Table-27.** No. of Eco-clubs established under the NGC Programme (since 2003-04)

S. No.	States/UTs	No. of Eco-clubs						
		*2009-10	2008-09	2007-08	2006-07	2005-06	2004-05	2003-04
1	Andman & Nicobar Islands (UT)		346					
2	Andhra Pradesh	5750	5750	5750	5750	3900	3900	3900
3	Arunachal Pradesh (NE)			525				
4	Assam (NE)	5207	4695					3450
5	Bihar	8971	8473	7200		5266	5700	5700
6	Chandigarh (UT)		115	113	112	110		150
7	Chhattisgarh	3932	3932	3932	4000	2373	2400	2400
8	Dadra & Nagar Haveli (UT)							
9	Daman & Diu (UT)							
10	Delhi (NCT)	1874	2000	1600	1600	1500	1500	1500
11	Goa	500		500	500	441	300	300
12	Gujarat	6750	6500	6500	6250	3750	3750	3750
13	Haryana		5000		5000	2850	2750	2750
14	Himachal Pradesh		3000		1693	1800	1800	1800
15	Jammu & Kashmir		5500					2100
16	Jharkhand						3300	3150
17	Karnataka		8000	8000			4800	4050
18	Kerala	3500	3500	3500			2100	
19	Lakshadweep (UT)						12	
20	Maharashtra	8898	8898	8844	8844	5400	5400	4950
21	Manipur (NE)			1350	1350		900	
22	Meghalaya (NE)							
23	Mizoram (NE)	1235	1235	1235	1200	1200	1200	1200
24	Madhya Pradesh	12500	12000	12000	7200	7200	7200	6750
25	Nagaland (NE)			2048	2107	800	800	
26	Orissa	7500	7500		5900	4500	4500	4500
27	Pudducherry (UT)		550	550		513	513	600
28	Punjab	5000	5000	5000	4250	2550	2550	1800
29	Rajasthan	8000	8000	8000	8000	4800	4800	3200
30	Sikkim (NE)					540		
31	Tamilnadu	7500	7500	7500	7500	4500	4500	4350
32	Tripura (NE)		600	600	600	600	600	600
33	Uttar Pradesh				10747	10500		10500
34	Uttaranchal			1950				1950
35	West Bengal		4750	4750	4750	2850	2850	2850
	<b>Total</b>	<b>87117</b>	<b>112884</b>	<b>91447</b>	<b>87353</b>	<b>67943</b>	<b>68125</b>	<b>78250</b>

\* as on 23.02.2010

## Annual Report 2009-2010

**Table-28.** Amount Sanctioned under NEAC

(Amount in Rs.)

State	Amount sanctioned (2009-10)	Amount sanctioned (2008-09)	Amount sanctioned (2007-08)	Amount sanctioned (2006-07)	Amount sanctioned (2005-06)	Amount sanctioned (2004-05)
Andhra Pradesh	5586000	4412000	3065000	3490500	3929000	3558500
Andaman & Nicobar Island	114000	83000	81000	103000	57000	38000
Arunachal Pradesh	-	-	152000	300000	-	-
Assam	2681000	2660000	2250000	1982000	2550000	2022000
Bihar	4982000	3985000	3303000	3033000	4313000	2426000
Chhattisgarh	619000	602000	734000	525000	741000	649000
Dadar & Nagar Haveli	-	12000	10000	-	10000	13000
Daman & Diu	55000	59000	42000	49000	30000	17000
Delhi	1171000	778000	595000	751000	808000	461000
Goa	14000	30000	26000	36000	37000	16500
Gujarat	3254500	1939000	2174550	1927000	1919000	1276000
Haryana & Chandigarh	3313000	1799000	1255000	809500	1078000	1086000
Himachal Pradesh	1251000	1200000	1256000	1026500	1130500	677000
Jammu & Kashmir	4470000	2811000	2638000	2534000	1041000	769000
Jharkhand	3322000	2473000	1768000	1616000	1425000	1041000
Karnataka	2320000	2135000	1078500	1539500	1652000	2001000
Kerala	1858000	1633000	1362000	1500000	1366000	614000
Lakshadweep	-	-	-	-	9000	-
Madhya Pradesh	6953000	5013000	4591000	4464000	4140000	3903000
Maharashtra	5260000	4730000	4021000	3871000	3939000	3504000
Manipur	2260500	2585000	2130000	1950000	2400000	2840000
Mizoram	515000	800000	430000	283000	-	-
Nagaland	606000	1063000	744000	501000	-	-
Orissa	7022000	4428000	3462000	3138000	2748500	3021400
Pondicherry	476000	550000	347000	264000	156000	150000
Punjab & Chandigarh	1755000	1415000	929000	805000	688000	602000
Rajasthan	2201000	1742000	1956000	1152000	1517000	1321500
Sikkim	398000	261000	771000	806000	563400	-
Tamilnadu	5214000	4397000	3129000	3402500	2813000	3249000
Tripura	1666000	1776000	1119000	1097000	1262000	949000
Uttar Pradesh	8852000	6504000	5013000	5719000	5744000	4291000
Uttaranchal	683000	565000	596000	379000	770000	349000
West Bengal	5046000	2942000	1739000	1576000	1766000	1280000
<b>Total</b>	<b>83918000</b>	<b>71992593</b>	<b>52767050</b>	<b>50629500</b>	<b>50602400</b>	<b>42124900</b>

Note: During 2003-04 to 2006-07 amount released under NEAC for Haryana & Chandigarh was combined. From 2007-08 onwards Chandigarh is clubbed with Punjab.

## National Museum of Natural History

The National Museum of Natural History (NMNH), New Delhi, a subordinate organization of the Ministry, was opened to public in 1978 with the main objective of creating public awareness in preservation and conservation of environment and nature through the means of museum exhibitions, educational programmes, outreach activities, etc. Since its inception, the NMNH has been temporarily housed in the FICCI Museum premises at Bharakhamba Road in New Delhi. The Ministry has been taking active steps in getting the land allotted by the Ministry of Urban Development to the NMNH for building its Headquarters in New Delhi.

Over the years, the Museum has extended its activities in different regions of the country and has set up three Regional Museums of Natural History (RMNH), one each at Mysore (Karnataka); Bhopal (Madhya Pradesh) and Bhubaneswar (Orissa). These museums have been established to depict flora, fauna, forests, wildlife and other environmental aspects of the respective regions.

Rajiv Gandhi Regional Museum of Natural History (RGRMNH) is being established at Sawai Madhopur (Rajasthan). Action has already commenced for construction of the RGRMNH building. A temporary office has been set up to conduct educational and other outreach activities in the region.

Further, this Ministry has approved the setting up of the fifth Regional Museum of Natural History near Gangtok (Sikkim) to extend the Museum's activities to the North-Eastern region which is a hotspot of biodiversity. Necessary budgetary provision has been included in this regard in the 11th

Five Year Plan. The Government of Sikkim has allotted six acres of land, adjacent to the Sikkim Science Centre at Marchak, East Sikkim, which is twelve kms. from Gangtok and approachable from National Highway No. 31, for the RMNH building. Action is being taken to take the actual possession of the allotted land and for getting necessary administrative and financial approvals for the establishment of this RMNH.

### Progress of Activities undertaken

**Educational Activities :** NMNH along with its Regional Museums of Natural History organized a number of in-house and outreach programmes for the benefit of school children, college students, teachers, challenged children and general public. Various national and international days of scientific relevance like World Wetland Day, World Day for Water, World Forestry Day, International Ozone Day, Conservation Day, Earth Day, World Environment Day, World Heritage Day, International Bio-diversity Day, World No Tobacco Day, Wildlife Week, World Habitat Day and National Environmental Awareness Campaign were observed and different programmes for school children and challenged children were also organized. The Museum organized different educational activities and competitions like Quiz, Declamation, On-the-spot Painting, Poster Making, Slogan writing, Essay writing, Model making, Bird Watching and Tree-spotting for the participating students on these occasions.

**Publications :** NMNH and its Regional Centres published a number of publications in English, Hindi, Kannada and Oriya on the topics related to animals, plants, bio-diversity and other environment related issues. To commemorate the International Bio-diversity Day, the NMNH



published a Special Desk Calendar based on the theme bio-diversity. This Desk Calendar was released by the Minister for State (Independent Charge), Environment & Forests at a function held in New Delhi on 04 January, 2010. The NMNH and its Regional Museums also published posters and booklets, including the Summer Programme magazine, on topics related to nature and environment.

### Exhibitions

- **RMNH, Mysore** – An Exhibition on “Silk – Gift of Nature” was organised in collaboration with Central Sericultural Research & Training Institute, Mysore on 04 August 2009 to create awareness about various aspects of silk among the masses. An Exhibition on Pets, entitled ‘Saaku Praanigalu – Preethi & Bheethi’, organized in collaboration with J.S.S. Medical College, Mysore, was inaugurated in the RMNH premises on 30 October 2009. This was inaugurated by the Adviser, Ministry of Environment & Forests
- **RMNH, Bhopal** – A temporary exhibition on “Museum and Tourism” was organized with the help of Madhya Pradesh Eco-Tourism Development Board on 18 May 2009 on the occasion of the International Museum Day.
- **RMNH, Bhubaneswar** – Mobile Exhibition – The Exhibition on Wheels on the theme of “Forest Wealth” traveled to different schools and colleges of Orissa during 01 October 2009 to 31 December 2009 and was visited by more than 5000 visitors. It actively participated in the Anjali National Children’s Festival held at Bhubaneswar from 09-14 November 2009.

### Workshops/Conferences

- **NMNH, New Delhi** – A three-day Workshop for Trainee Teachers from the District Institute of Education and Training (DIET), Darya Ganj was organized from 20 to 22 August, 2009 to enrich teachers in class-room teaching on environmental issues. This workshop included a Nature Study Tour to Aravalli Bio-diversity Park. The participants got hands-on experience in making low-cost science models.
  - **RMNH, Mysore** – A National Conference on Museum Accessibility was organized during 24-25 July 2009 at Thiruvanthapuram in collaboration with the Directorate of Museums & Zoos, Government of Kerala. A three-day Teacher Orientation Workshop was organized in Hunsur (Karnataka) from 24-26 August 2009 for Higher Primary Teachers. A one-day Workshop on Butterflies was organized on 06 August 2009 in collaboration with an NGO, Arivu Educational and Cultural Trust, Mysore. A book, titled “Chitaigalu”, written by Sri Krishna Das in Kannada about Butterflies, was released on the occasion.
  - **RMNH, Bhopal** – A three-day workshop titled “Creature Like Kite” was organised on 08 August, 2009 for students of classes IX to XI from various schools of Bhopal. The aim of the workshop was to teach students kite making in the shape of birds and animals etc.
- A two-day Workshop on “Trees–A Capacity Building Programme” was organized on 23-24 December, 2009. The aim of this workshop was to identify trees of Bhopal, their ecological importance and the ecosystem services rendered by these trees.

A national Seminar entitled "Integrated Management of Water Resources with reference to Bio-diversity and livelihood" was organized on 16-17 January 2010 as a collaborative host. The Madhya Pradesh Minister of Farmer Welfare and Agriculture Development was the Chief Guest.

Another Workshop on "Prevention and Conservation of Natural History Collection" is being held on 22-23 January 2010.

- **RMNH, Bhubaneswar** – A three-day Orientation Workshop for Teacher Trainees of the Regional Institute of Education, Bhubaneswar was organized on 27-29 November 2009 where thirty teacher trainees were exposed to the estuarine ecosystem of Bhitarkanika National Park and Brackish Water Eco-system of Chilka Lagoon

### Meetings of the Advisory Committee

- The second meeting of the Advisory Committee of Regional Museum of Natural History (RMNH), Bhubaneswar was held under the chairmanship of Adviser (RE and NMNH), Ministry of Environment & Forests on 11 August 2009 at Bhubaneswar.
- The second meeting of the Advisory Committee of Regional Museum of Natural History (RMNH), Mysore was held in Mysore under the chairmanship of Dr. M.S. Nagaraja Rao, former Director General, Archaeological Survey of India on 29 October 2009

### Collaborative Programme

- NMNH, New Delhi - Environmental Education Partnership with CMS Vatavaran 2009 – The NMNH, in partnership with CMS VATAVARAN, hosted an Environment and Wildlife Film Festival and CMS

Environment Forum from 27-31 October 2009 at India Habitat Centre, New Delhi.

- RMNH, Bhubaneswar - 12th Orissa Bigyan Congress - The Indian Science Congress Association (Bhubaneswar Chapter), the Orissa Environmental Society and the RMNH, Bhubaneswar collaboratively organized the 12th Orissa Bigyan Congress from 05-06 December 2009 on the focal theme of "Science and Technology Challenges of 21st Century: National Perspective".

National Teachers Science Congress – The RMNH participated in an exhibition conducted at the Regional Institute of Education, Bhubaneswar from 01-04 October 2009 on the occasion of the 5th National Teachers Science Congress on the theme of "Understanding Planet Earth".

Capacity Building Programme for Research Fellows: The RMNH, in collaboration with the Nandan Kanan Zoo Park organized a Capacity Building Programme on Elephant Management Action Plan for Research Scholars from different Forest divisions of Orissa.

- RMNH, Bhopal - An NGO Meet was organized on 12 November 2009 in collaboration with CPCB, Bhopal in which 70 representatives from various NGOs of Bhopal attended the Meet to prepare Agenda for better environment.

The Science Centre, Bhopal organized a Children Science Congress during 04-06 December 2009 in collaboration with the RMNH, Bhopal

### World Environment Day

World Environment Day and the 31<sup>st</sup> Anniversary of the NMNH Foundation Day

were observed on 05 June, 2009. The function was organized at the Plenary Hall of Vigyan Bhawan, New Delhi. Hon'ble President of India Smt. Pratibha Devi Singh Patil was the Chief Guest at the function. Master Aviral Saxena from Bhopal was decorated by the Hon'ble President as the "Young Environmentalist of the Year 2009".

### Van Mahotsava 2009

- NMNH, New Delhi - On 05 July 2009, special slide shows and CD presentations on forest resources followed by a Talk on 'Our forest resources' was organized for the orphan children of Bal Vihar Children Home.
- RMNH, Mysore - Plantation of saplings and series of lectures were organised at various schools in Mysore. A visit to heritage sites was also organized for the school students during 02-04 July 2009.

### Summer Nature Study Programme

- NMNH, New Delhi - NMNH, New Delhi organized Summer Nature Study Programme from 15 May to 15 June 2009 in which 40 students from all over Delhi and NCR participated. As part of this programme these children were taken to Nature Study Tour to G.B. Pant Institute of Himalayan and Development, Kosi-Kattarmal, Almora (Uttarakhand)
- RMNH, Mysore - RMNH, Mysore organized Summer Nature Study Programme for the school student during 10th to 20th June, 2009. The participants were taken to field trip to nearby National Park and Bird Sanctuaries for study on nature and wildlife.
- RMNH, Bhopal - 'Prakriti 2009', the Summer Nature Study Programme was

launched on World Environment Day in which thirty five students from Classes VIII to X from various schools of Bhopal participated.

- RMNH, Bhubaneswar - A Summer Nature Study Programme was organized in association with the Paribesh Unayan Parishad of West Bengal from 13-16 June 2009. A team of twenty one students from various streams participated. The students also visited the Nandan Kanan Zoological Park, Kanjia Lake and studied the various aspects of nature.

### International Ozone Day

- NMNH, New Delhi - A declamation contest was conducted for students of Delhi and NCR on 16th September, 2009. The topic of contest was "Your Role in being an Ozone Friendly Citizen".
- RMNH, Mysore - To commemorate the International Ozone Day, the Museum organized a Quiz Competition, a Debate Competition and a Public Lecture for the general public on 16 September, 2009.

### National Environment Awareness Campaign (NEAC)

- NMNH, New Delhi - The NMNH, New Delhi organised a written Quiz competition on the theme Climate Change on 19th November, 2009 for the students of 8th, 9th and 10th class from Delhi and NCR. As part of NEAC to commemorate Conservation Day, NMNH in collaboration with Hindustan Times organized annual inter-school essay competition.
- RMNH, Mysore - The RMNH organized various competitions for school students like painting, written quiz, debate and slogan

writing with a view to create awareness on environmental issues.

- RMNH, Bhopal – The RMNH organized a poem composition-cum- recitation competition on 15 December, 2009 on the topic of 'Climate Change' in which thirty participants from fourteen schools of Bhopal participated. A written Quiz Competition was also organized by the Museum on 19 November, 2009 in which one hundred ninety three students from twenty schools participated.

### Wildlife Week

- To commemorate the Wildlife Week, the NMNH, New Delhi and its Regional Centres at Mysore, Bhopal, Bhubaneswar and Sawai Madhopur conducted a National Poster Design Contest for the students Classes VIII, IX and XII, the theme of the contest being "Our Rich Biodiversity".

### Darwin 200 – India Poster Design Contest

- As part of commemoration of Charles Darwin's bicentennial birthday celebrations the world over, the NMNH, New Delhi and its Regional Centres at Mysore, Bhopal, Bhubaneswar and Sawai Madhopur, in collaboration with the UNESCO, organized a National level Poster Design Contest on 18 April, 2009 for students of Class X & XI. The theme of the contest was "Darwin and Evolution".

### Earth Day

- A national level Written Quiz Contest was organized on 22 April, 2009 for students of Classes IX and X on the theme of 'Climate Change'. The contest was simultaneously

conducted at Delhi, Mysore, Bhopal, Bhubaneswar and Sawai Madhopur.

### Reserve collection enrichment and Taxidermy work

- RMNH, Bhopal - The skull of white tigress "Rashmi" of Van Vihar National Park was cleaned, treated and handed over on 10 July 2009. The Tiger skin, received from District Forest Officer (DFO), General Forest Division, Katni, Madhya Pradesh for treatment, was cleaned, cured, treated and handed over to the D.F.O., Katni on 22 July 2009.
- RMNH, Bhubaneswar - A 7½' female bottle nose dolphin was retrieved from Berhampur coast of Orissa, 2009 and the whole skeleton was prepared & mounted for display in the gallery. Apart from this, skinning of a dead flying squirrel handed over by Zoo Authority was done. Dissection of a bat found with a baby was done to retrieve its skull.

### Film shows

- Regular film shows were arranged for visitors in National Museum of Natural History, New Delhi and its Regional Centres at Mysore, Bhopal & Bhubaneswar to sensitize and create awareness among general visitors on issues of nature and environment

### Forestry Education, Training and Extension

The present system of forestry education and training is tailored to produce skilled forest managers to manage, protect and conserve the forests in consonance with National Forest Policy, 1988, forestry action programmes etc. The activities related to forestry education, training and extension are performed by the

different institute of the Ministry like Indira Gandhi National Forest Academy (IGNFA), Dehradun; Directorate of Forest Education (DFE), Dehradun; ICFRE, Dehradun; IIFM, Bhopal; IPIRTI, Bengaluru.

Progress of activities undertaken by various institutes

### Indira Gandhi National Forest Academy (IGNFA), Dehradun

Indira Gandhi National Forest Academy is the training centre for IFS Officers. The institution undertakes training of new recruits to the Indian Forest Service which is spread over a period of twenty months. Besides this, the institution also undertakes training of IFS Officers at various years of seniority and also of other Stakeholders. The Academy was a part of FRI in Dehradun. This institution earlier functioned as Indian Forest College from 1938-1987. In 1987, when the Indian Council of Forestry Research and Education (ICFRE) was established as an autonomous institution, the Indian Forest College was named as Indira Gandhi National Forest Academy (IGNFA) in recognition of the late Prime Minister to the forestry sector in the country. The IGNFA functions as an institution directly under the control of Ministry of Environment and Forests.

#### Major activities during the year

– Programmes of IFS Officers at ten, seventeen and twenty one years of service spread over a period of two to three weeks. However, starting this current year, the Mid Career Training Programmes in the revised format are conducted in IGNFA as a part of administrative reforms on the behalf of Prime Minister. The eight weeks' training for IFS Officers of seven to nine years of service is being conducted at IGNFA between

Dec-Feb. 2009. One such programme for IFS Officers of sixteen to eighteen years of service will be conducted in Feb.-March, 2010. The Mid Career Training Programme of IFS Officers of seven to nine years of service is spread over a period of eight weeks and includes one week training programme on management issues at IIM Ahmedabad and two weeks visit abroad. Half of the group will be visiting Colorado University in USA and the other half will be visiting Sweden.

The Mid Career Training programme of Officers of sixteen to eighteen years of service is spread over a period of eight weeks and includes one week in IIM – Lucknow and two weeks visit abroad- half the group will be going to Yale University, United States and other half will be visiting Finland.

– The 2007-09 batch of Indian Forest Service Officers passed out in Aug. 2009. The Convocation Ceremony was held on 10<sup>th</sup> Aug. 2009, in Convocation Hall of FRI building. The Chief Guest for the function was the Deputy Chairman of Planning Commission Sh. Montek Singh Ahluwalia and the function was presided over by Shri Jairam Ramesh, the Hon'ble Minister for Forests and Environment, Government of India.

– During the current year, IGNFA undertook three coordination training programmes for the three All India Service Officers. The four days' training programmes for IAS, IPS and IFS Officers included one day field visit to Rajaji National Park. The broad theme of training programme was "The Ecological Security" of the country. These training

programmes were conducted between Sept. to Dec. 2009 and were well received.

- The intake to the Indian Forest Service over the last ten years had been ranging between twenty five to thirty. However, since the current year the intake has increased and the new batch of IFS probationers of 2009-11 course consists of eighty three young officers.
- In order to create general awareness and sensitize forest officers of various States on the issues involved in the mitigation and adaptations in forestry Management practices a two-day's workshop on "Climate Change and Response of Forestry Sector" was held in Aug. 2009 for IFS Officers of 1979 batch.
- Keeping in view the need for enhanced inputs on wildlife conservation to the IFS probationers, the syllabus of Wildlife and Biodiversity subjects was revised and training of IFS probationers with increased inputs on wildlife conservation started in this current year. A net increase of 72% in the inputs on the wildlife management has been effected through revision of the syllabus.
- Induction training of forest officers inducted into the Indian Forest Service by promotion from State Forest Service was conducted in the month of Sept. to Dec. in which thirty four officers participated.
- Advanced Forest Management Training of IFS Officers of 2000 Year of Allotment spread over a period of three weeks was conducted in the month of May- June in which fifty one officers participated.
- Two reunion workshops for the retired forest officers who underwent training in this

institute during 1957-60 and 1958-61 were held in the Academy in May & Sept. 2009. In these workshops, the old retired officers interacted with the young IFS probationers and shared their past experience and knowledge.

- A four days Forest & Environment Clearance training programme for executives of power sector was held in the month of October.
- One week compulsory course for IFS officers on policy and legal issues of Forestry Sector was conducted in June 2009, which was attended by twenty one IFS officers.

### Visit of Dignitaries

- In the beginning of June 2009, the Hon'ble Forest and Environment Minister - Shri Jairam Ramesh visited IGNFA soon after becoming the Minister of Environment & Forests.
- Shri Vijai Sharma, Secretary Environment and Forests, Government of India visited IGNFA in April 2009.
- DGF & SS Dr.P.J.Dilip Kumar, visited and addressed IFS Prob. in Aug, 2009

### Directorate of Forest Education (DFE), Dehradun

The Directorate of Forest Education (DFE) under the Ministry is responsible for imparting professional/technical training/education in the Country to the State Forest Service Officers and Forest Range Officers. The Directorate also supplements the efforts of Forest Training Institutes of various States for the training and capacity building of the Forest Frontline Staff (Deputy Rangers, Foresters and Forest Guards). There are three State Forest Colleges at Dehradun, Burnihat & Coimbatore and one College at Kurseong under the Directorate. The three State Forest Colleges

were renamed by the Minister as Central Academies for State Forest Service Officers. The names and intake capacity (Per batch) of these academies and colleges are as under.

- Central Academy for State Forest Service, Dehradun 40
- Central Academy for State Forest Service, Coimbatore 40
- Central Academy for State Forest Service, Burnihat 40
- Eastern Forest Rangers College, Kurseong 30

### Mandate

- To cater to the training needs of State Forest Service (SFS) Officers and Forest Range Officers (FROs) of States/ Union Territories in the country.
- To ensure standard and quality of training being imparted to SFS Officers and FROs.
- To develop appropriate and relevant training contents and evaluation standards for forestry training at various levels.
- To suggest training policy for effective Human Resource Management and Development.
- To supplement the efforts of State Governments in the training of Forest Frontline Staff (Forest Guards, Foresters and Deputy Rangers)

### Activities undertaken/ Achievements during the year

- A new technical cooperation project titled 'Capacity Development' of State Forest Training Institutions and SFS colleges has been launched with the support of Japan International Cooperation Agency (JICA). The project is aimed for improvement of

in-service refresher training courses for State Forest Service Officer.

- Induction training in the form of "Two year Diploma Course" for the newly recruited State Forest Service (SFS) Officers of various States/Union Territories has been undertaken. Three batches, Course 2008-10 (One) & Course 2009-11 (Two), of newly recruited SFS Officers are undergoing training at Central Academy for State Forest Service (SFS), Dehradun & Coimbatore.
- One batch, Course 2007-2009 of newly recruited SFS officers passed out from Central Academy for SFS, Dehradun.
- Induction training in the form of "Eighteen months certificate course" for the newly recruited Forest Range Officers (FROs) of various states/Union Territories has been undertaken. Two batches, Courses 2008-10 & 2009-10, are undergoing training at Central Academy for SFS, Coimbatore & Burnihat respectively.
- Two batches of newly recruited FROs, Course 2008-09 (Two), passed out from Central Academy for SFS, Coimbatore & Burnihat respectively.
- Seven General Refresher courses, each of two week duration, were conducted for in-service SFS Officers at Central Academy for SFS, Dehradun, Coimbatore and Burnihat.
- Two Computer Application courses in Forestry, of two weeks duration each, were conducted for in-service SFS Officers/FROs at Central Academy for SFS, Dehradun and Eastern Forest Rangers College (EFRC), Kurseong respectively.



## Ministry of Environment & Forests

- Five Workshops of one week duration each on Human Resources Management Issues in Forestry, Training of Trainers, Biodiversity Conservation & Eco-Tourism, JFM & Livelihood options through Natural Resources Management, Forestry Prospective in Global warming & Climate Change were conducted for in-service SFS Officers at Central Academy for SFS, Dehradun and Coimbatore.
- One theme based course in Forestry/Wildlife management of two weeks duration for in-service FROs was conducted at EFRC, Kurseong.
- “Seventy” General Refresher Courses, each of two weeks duration, were conducted for in-service Forest Frontline Staff (Deputy Rangers, Foresters & Forest Guards) through forty nine Forestry Training Institutions of twenty nine states.
- One Theme based workshops of one week duration on Good Practices in Forestry was conducted for in-service Forest Range Officers (FROs) through one of the State Forest Training Institutes.

### Training of IFS Officers

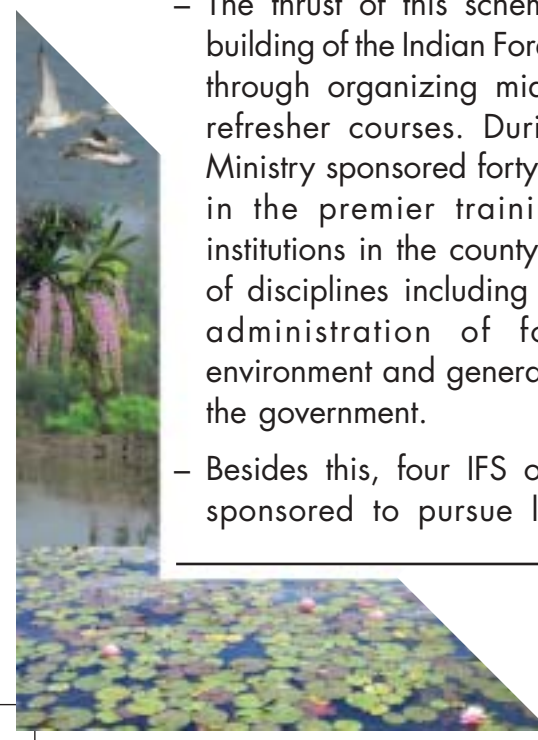
- 
- The thrust of this scheme is on capacity building of the Indian Forest Service Officers through organizing mid-career short-term refresher courses. During the year, the Ministry sponsored forty one-week courses in the premier training/management institutions in the country on a wide range of disciplines including management and administration of forests, wildlife, environment and general administration in the government.
  - Besides this, four IFS officers have been sponsored to pursue long-term courses

offered by the Indian Institute of Management (IIM), Bangalore and Indian Institute of Management (IIM), Ahmedbad

- During the year, the Ministry sponsored eleven two-day workshops on emerging topics in the field of forests, wildlife and environment conservation having regional, national and international importance. The training workshops/seminars are sponsored in the premier institutions/organizations depending upon their expertise and strengths in a particular field/discipline.

### Budget Allocation

The Budget allocation during 2009-10 of this scheme was Rs. 2.00 crore (Plan).

### Indian Institute of Forest Management (IIFM), Bhopal

The Indian Institute of Forest Management (IIFM), Bhopal as a sectoral management institute and an autonomous institute of the Ministry imparts education and training in forest management.

### Education

The Institute offers two academic programmes. Post Graduate Programme in Forestry Management (equivalent to Master Degree) and Fellow Programme in Management. The Institute is also recognized as Nodal Centre for Research by Forest Research Institute Deemed University (FRI), Dehradun for Doctoral programmes

### Post Graduate Diploma in Forest Management (PGDFM)

The two year postgraduate programme leading to the award of the Post Graduate Diploma in Forestry Management (PGDFM) was launched in July 1988. The students with



diverse academic backgrounds drawn from all over the country are groomed to meet the managerial requirements of the development and corporate sectors.

The admission to this course is through CAT (Common Admissions Test) being conducted by IIMs followed by Group Discussion (GD) & Personal Interview (PI) at IIFM. From the year 2008, specialisations in Conservation and Livelihood Management (C&L), Environmental Management (EM) and Development Management (DM) has been introduced in the programme.

The 22nd batch of the PGDFM course consists of seventy two students. Among these forty seven come under General Category; eleven belong to SC category; five belong to ST Category; seven belong to OBC and rest two are admitted under PD quota. The batch also consists of 25% female students and they all come from almost all the parts of the country, representing nineteen states. Following the general trend in the management education, in this batch also the engineers is the dominant group, consisting almost 40% of the total strength. This is followed by the students of Science stream (21%), Arts & Commerce (10% each). Apart from this, the batch also consists of management graduates and veterinary graduates. The profile of the students reveals that the fresh students exhibit varied range of extra curricular interest and talent.

Following the tradition, all the students of PGDFM being passed out in March 2010 got placed through campus recruitment held during January 2010 registering an improvement over the last year's campus placement. The scenario of the Summer Internship was also quite encouraging during this year.

### Fellow Programme in Management (FPM)

The Institute launched its Doctoral level Fellow Programme in Management (FPM) 2010-14. The Fellow Programme in Management (FPM) offers financial assistance and contingency grants to selected non-sponsored candidates. The programme is open to postgraduates from various disciplines and is designed to provide specialized knowledge, skills, and attitudes for positions requiring conceptual and visioning skills. The FPM programme aims to develop and equip students for career opportunities in management education and research.

### Ph.D. Programme

The Institute functions as one of the research centers of the FRI Deemed University for higher studies leading to Doctor of Philosophy.

### Indian Plywood Industries Research and Training Institute (IPIRTI), Bengaluru

The Institute caters to HRD needs of the wood based panel industries through several training programmes including one year PG Diploma Course in "PGD course in Wood and Panel Products Technology". Till date twenty batches of PGD courses have been conducted wherein more than four hundred seventy eight candidates have been trained and placed in various wood and wood-based industries all over the country. All members that syllabus for PGD course has been upgraded from this year including the Management parts in consultation with Indian Institute of Forest Management, Bhopal. To provide expertise and manpower support to implement the Management subject, Institute of Business Management, Bangalore has been approached. IPIRTI is also a center recognized

by Forest Research Institute Deemed University for pursuing research leading to award to Ph.D.

This year on demand of the industries, fourteen short-term courses were conducted in various fields of plywood manufacturing and adhesives, etc. in which ninety seven candidates were trained. One Week Compulsory Training Course for IFS Officers from all over India was conducted from 20<sup>th</sup> to 24<sup>th</sup> July 2009 on the theme "Bamboo Resource Development for Addressing Livelihood Concerns of Communities" wherein fifteen IFS Officers participated.

One International Special Training course of twelve days duration, on "Preliminary processing of bamboo, its preservation and mat weaving" was conducted for the candidates sponsored by International Habitat for Humanity, Nepal under the project "Transfer of technology for the manufacture of Bamboo mat corrugated sheet".

### Product Testing and Standardization



The Institute continues to play a significant role in formulating/amending Indian Standards for wood, wood products and other lignocellulosic materials through active participation in various committees of the Bureau of Indian Standards [BIS]. As and when required, recommendations are also sent to BIS for incorporating changes in the tests to be conducted for conformation to Indian Standards. The Institute is a recognized center for testing and standardization in respect of all wood products and composites/panels from wood and other lignocellulosics. The facilities are availed by Central and State Public Works Departments, BIS, DGS&D, Customs, etc.

Recently CENTEC LABS of the Institute have obtained NABL accreditation for testing

and evaluation of wood composites, in accordance with ISO/IEC 17025:2005.

To cater to the needs of northwest and northern plywood industries, a new IPIRTI Centre at Mohali, near Chandigarh was established recently fulfilling the long pending demand of the Northern India Plywood Manufacturer's Association (NIPMA). This IPIRTI Centre laboratory also got recognized for testing and evaluation of wood composites recently by Bureau of Indian Standards.

### Extension

- **Establishment of CFC at Magadi, Bangalore** : With the financial grants received from NMBA & technical support provided by IPIRTI CENTRE for preliminary processing of bamboo was established at Magadi, Bangalore. About fifty six artisans trained in operation of bamboo processing machines, about three hundred families of tribes traditionally involved in bamboo based activities will be benefited and nearly two hundred fifty mats produced will be utilized for manufacturing the industrial products like BMB, BMCS, BMT and agarbathi sticks.
- The Institute has organized two-day Workshop on "Carbon Sequestration through Wood & Bamboo products" for the IFS officers sponsored by MoEF during 7-8<sup>th</sup> December 2009. The basic objective of organizing this workshop on such important subject is to explore and raise awareness to the different approaches, methods and models for carbon accounting in wood and wood based products and to investigate and strengthen the role of forest products for climate change mitigation.

## Wildlife Education and Training

Wildlife education and training is primarily looked after by Wildlife Institute of India (WII), Dehradun; an autonomous institute for imparting training to government and non-governmental personnel to carry out research and training activities and advice on matters of conservation and management of wildlife resources. The details of educational and training programmes conducted by the Institute are as follows:

### Academics and Training

#### Courses and Training Programmes

- The National Entrance Test (NET) of the ongoing XII M.Sc. (Wildlife Science) Course was conducted at six centres of the country viz. Bangalore, Delhi, Dehradun, Guwahati, Kolkata, and Mumbai on April 19, 2009. A total of two hundred six students appeared in the entrance test and eleven candidates (nine Indians and two foreign nationals) joined the course.
- *XXX P.G. Diploma in Wildlife Management* commenced on September 1, 2008 for nine-month duration at the Institute. Seven officer trainees joined the course, of which three were from Forest Departments of various Indian States and four from neighbouring countries.
- *XXXI Post-Graduate Diploma Course in Wildlife Management* commenced on September 1, 2009 for eight month duration with eleven officer trainees. Seven of them are from the Forest Departments of various States in India, one self-sponsored veterinarian and three from neighbouring countries. The officer trainees visited Rajaji National Park from September 22 to 27, 2009 for their Orientation Tour.

- *XXV Certificate Course in Wildlife Management* commenced on November 1, 2009 for three-month duration. In all, twenty one officer trainees (Range Forest Officers and equivalent) from different States within country including six foreign nationals have joined the course

### Meetings, Workshops, Seminars and Conferences

- *Training Course on Environmental Impact Assessment (EIA) for Biodiversity Conservation for Indian Forest Service Officers, Dehradun, September 7-11, 2009.* The training course aimed to empower the natural resource managers for a careful review of proposals seeking diversion of forested areas for developments in economic sectors such as mineral extraction, dam building and linear alignments of roads and power grids through forested areas. A total of twenty officers participated in the course.
- *Department of Science and Technology (DST) Fast Track Young Scientists Programme Expert Panel Meeting, Dehradun, September 30 to October 1, 2009.* Department of Science and Technology (DST), Govt. of India, New Delhi has been providing financial assistance to young scientists in various areas of their interest through fast track research project programme. For the first time, the expert panel meeting was held in the Institute. Ten experts from various Indian universities and research institutions along with Director, Science and Engineering Research Council (SERC-DST) participated in the meeting.
- *V-Internal Annual Research Seminar (IARS), September 17-18, 2009.* 22 presentations were made in five sessions of IARS, which included studies on large carnivores,

herpetofaunal studies, human dimensions and development related aspects, avifaunal studies, molecular genetics and forensics, and studies on arthropods. The presentations made by M.Sc. students, research fellows and faculty members of the Institute were based on recently initiated and ongoing research studies.

- The XXIII Annual Research Seminar of the Institute was conducted at WII wherein twenty four presentations were made in nine sessions.
- *Regional Workshop for Asia and the Pacific on the review of progress and capacity building for the implementation of the PoWPA, 12-15 October 2009.* Asia Pacific regional workshop was organized by the Secretariat of the Convention on Biological Diversity in collaboration with the Ministry of Environment and Forests, Government of India and hosted by the Wildlife Institute of India. Sixty four Representative from twenty eight countries participated in this workshop.
- *International Exhibition on “Climate Change: Technology Development and Transfer”, New Delhi, October 22-23, 2009.* The exhibition was jointly organized by the Ministry of Environment & Forests and Confederation of Indian Industry. The unique exhibition with one hundred forty stalls showcased India’s efforts to address the challenge of climate change. The exhibition was inaugurated by Shri Pranab Mukherjee, Minister of Finance, Government of India in Vigyan Bhawan, New Delhi.
- *Wildlife Techniques Tour for IGNFA Probationers (2007-2009 Batch) in Sariska Tiger Reserve, Rajasthan, November 1-6, 2009.* Twenty nine probationers

participated in the Wildlife Techniques Tour, wherein field techniques pertaining to plant and wild animal quantification using direct and indirect evidences, radio-telemetry, mist netting and camera trapping were demonstrated.

- *Interactive Workshop on Wildlife Conservation Issues for Media Personnel, New Delhi, December 9-10, 2009.* An interactive workshop was organised by the Institute at India Habitat Centre for media personnel to share these concerns in wildlife conservation in India and provide a platform to generate ideas on informative news reporting about current wildlife crisis. Shri Jairam Ramesh, Minister of State (Independent Charge), Environment and Forests, Government of India inaugurated the workshop. A total of twenty three participants from different media participated in this interactive workshop.
- *Two-Week Special Short-term Course in Wildlife Protection, Law & Forensic Science for Probationers of Indian Revenue Service (Customs & Central Excise), Group ‘A’ (60<sup>th</sup> Batch) - First Group, Dehradun, December 14-24, 2009.* The course was sponsored by National Academy of Customs, Central Excise and Narcotics, Faridabad, Haryana. A total of fifty three participants attended the course. This training programme was conducted as a part of Institute’s regular capacity building initiatives for enforcement agencies dealing with wildlife trade
- *One-Week Compulsory Training Programme on “Ecotourism and Livelihoods” for IFS Officers, Periyar Tiger Reserve, Thekkady, Kerala, January 4-8, 2010.* A total of twenty one participants took part in the training.

**CHAPTER - 9**  
**CENTRES OF**  
**EXCELLENCE**



## Centres of Excellence

Enhancement of people's awareness about environment requires capacity building at institutional and individual level for providing adequate support to the efforts in the fields of environment education, research and training. To serve this end, the Ministry launched the scheme 'Centres of Excellence' in 1983 to promote institutions in priority areas of Environmental Sciences and Management.

Ten Centres of Excellence have so far been set up in different areas as listed below:

- (i) Centre for Environment Education(CEE), Ahmedabad
- (ii) CPR Environmental Education Centre(CPREEC), Chennai
- (iii) Centre for Ecological Sciences(CES), Indian Institute of Science (IISc), Bengaluru
- (iv) Centre of Mining Environment (CME), Indian School of Mines, Dhanbad
- (v) Salim Ali Centre for Ornithology and Natural History(SACON), Coimbatore
- (vi) Centre for Environment Management of Degraded Ecosystem(CEMDE), University of Delhi, Delhi
- (vii) Madras School of Economics(MSE), Chennai
- (viii) Foundation for Revitalization of Local Health Traditions(FRLHT), Bengaluru
- (ix) The Tropical Botanic Garden and Research Institute (TBGRI), Thiruvananthapuram
- (x) Centre for Animals and Environment, CARTMAN, Bengaluru.

## Centre for Environment Education (CEE), Ahmedabad

Centre for Environment Education (CEE) was established in 1984 as a Centre

of Excellence in Environmental Education, supported by the Ministry of Environment and Forests (MoEF), Government of India, in recognition of the importance of environmental education in India's overall environment and development strategy. CEE is a national institution engaged in developing programmes and material to increase awareness and concern, leading to action, regarding the environment and sustainable development. It has inherited the rich multidisciplinary resource base and varied experience of Nehru Foundation for Development (NFD), its parent organization, which has been promoting educational efforts since 1966 in the areas of science, nature study, health, development and environment.

## Progress / Achievements made during the year

### Pick Right and 'Kaun Banega Bharat ka Paryavaran Ambassador' Campaign

The Pick Right campaign is aimed at spreading awareness about climate change, its causes and effects, and individuals choosing the best options for sustainability. The Paryavaran Ambassador campaign will help choose a person to be a spokesperson on environmental issues, who can encourage people to make right lifestyle choices.

Under these two campaigns launched in 2008, 'Pick Right' educational pack consisting of a booklet, two sets of posters, two sticker-sheets, a post-card has been developed in fifteen languages. Two lakh schools across India participated in this campaign. It included schools sending in their vote for a role model who could inspire people on the path to sustainability. Dr. APJ Abdul Kalam emerged as the popular choice of

children. A total of seventy thousand schools actively participated in the voting process. Web-based polling was also conducted through the KBPA website [www.kbpa.com](http://www.kbpa.com) for the general public. Dr APJ Abdul Kalam was felicitated by Shri Jairam Ramesh, Minister of State (independent charge) for Environment and Forests as "Bharat Ka Paryavaran Ambassador" on 9th December, 2009 in New Delhi. As part of the programme Dr Kalam gave away plants to all the schools present. This was done as one of the many initiatives which would be taken in schools as part of the second phase of the climate change and sustainability programme by CEE, MoEF, and Arcelor Mittal, for the next three years.

### Management Education Centre on Climate Change

CEE and Gujarat University have jointly established the Management Education Centre on Climate Change (MEC CC) as a step towards climate change education. The main activities of the MEC CC focus on capacity building through short term and long term courses, research and development activities, field visits, research guideships, conducting seminars and symposia, etc.

Twenty students have enrolled themselves in the first batch of MSc. course in Climate Change, and classes have commenced.

### Public Consultations

MoEF commissioned CEE to hold ten consultations in various parts of the country involving local and fishing community to gather the public opinion and suggestions for improvement and to strengthen the existing CRZ notification 1991. The first of ten in the second round of consultations to elicit views

and recommendations on the Coastal Regulation Zone (CRZ) Notification was initiated in Mumbai on 12 August, 2009. People from all walks of life including fishermen, urban middle class people living in the CRZ, and NGOs were present. Hon. Minister of State for Environment and Forests, Shri Jairam Ramesh participated in the process at Mumbai, Goa and Chennai.

A team from CEE, was at Copenhagen participating in different events.

Also, in order to closely follow the developments and discussions at Conference of Parties (COP 15) in Copenhagen, CEE also set up *Copenhagen Newsroom* at its campus in Ahmedabad from the 7-18 December. The CEE Copenhagen Newsroom collated, discussed and assessed the events and outcomes of Copenhagen. The CEE team at Copenhagen enriched the process by providing first hand information on all decisions and updates. Discussion with local experts from various institutions in the city provided the local flavour. A press note on the daily outcomes of the talks at Copenhagen was released every evening for the twelve days.

### Asia/Pacific Cultural Centre for UNESCO (ACCU) Exhibition

The Asia/Pacific Cultural Centre for UNESCO (ACCU), Japan held an Asia-Pacific ESD Photo Message Contest "Letters to Tomorrow 2007" with a focus on the celebration of our living culture. The exhibition displayed the prize-winning entries from the Asia-Pacific ESD Photo Message Contest "Letters to Tomorrow 2007".

CEE hosted the Asia/Pacific Cultural Centre for UNESCO (ACCU) Photo Message Exhibition in India, at Ahmedabad, Jaipur

and Pune. Over four thousand people visited the exhibition and it had a host of activities that celebrated the living culture. The programmes have been planned to link the living culture of the host city with the exhibition.

The exhibition aims to develop an understanding and respect for different cultures and traditions. It provides an opportunity for critical reflection and dialogue with practitioners and interaction with the community on culture, society and sustainability issues of conserving culture as a heritage. Three countries of the Asia-Pacific region – Japan, Mongolia and India –simultaneously held the Photo message exhibition between October and December 2009.

### Hands for Change - Teach India Campaign

*Hands for Change-Teach India Campaign* is a joint initiative of CEE and the Times of India that aims at educating the underprivileged kids with the help of volunteers. CEE worked with about two hundred thirty volunteers in around seventy Centres in twenty three slum localities of Ahmedabad. The Campaign focused on the theme 'Myself and My Surroundings' and taught functional English and numeric skills to the children through a series of modules developed to guide the volunteers through the twelve weeks.

### Sustainable Schools Programme

CEE as part of its Sustainable Schools Programme (SSP) continued to involve schools in a variety of hands on activities to create awareness and understanding on issues of sustainability. The programme consolidates CEE's twenty five years of experience in school education. It offers tried and tested pedagogical approaches as well as use new

developments like ICT for teaching and learning. CEE is facilitating and conducting year long environmental education and education for sustainable development activities for the students of various schools in Ahmedabad.

### Facilitating Community-led Initiatives through Small Grants Programme

CEE continued to support activities which demonstrate community-based innovative, gender-sensitive approaches and lessons learned from other development projects that could reduce threats to local and global environment, under the Small Grants Programme (SGP), funded by the Global Environment Facility (GEF). UNDP and MoEF jointly administer SGP in India, and CEE is the National Host Institution (NHI) since 2000. The programme has so far supported and facilitated three hundred three action-based, community-led initiatives countrywide.

### Educational Experiences through Interpretation

CEE's interpretation programmes seek to convert the visits of people to natural and cultural heritage sites into an educational opportunity. They enhance the nature experience by providing on-site information through signages and exhibits, create a strong impact and go a long way towards increasing public commitment to the cause of conservation. Increasingly, interpretation is also emerging as a vital tool that helps to impress on visitors the critical link between environment and sustainable development. Some of the projects taken up during the period are:

- Construction of Main Gate at Madhav National Park, Shivpuri, Madhya Pradesh.



- Interactive Map and wall mounted vinyl prints showing India's forest cover maps in the chamber of Hon'ble Minister of State (I/C), Environment & Forests, Gol.
- Setting up of signages, hoardings, dioramas, relief map etc. for Department of Tourism, Meghalaya
- Installation of Nature trails, photo-text panels and bird interactive at Tipeswar Wildlife Sanctuary, Maharashtra.
- Interpretation Centre for Mahatma Gandhi Marine National Park, Wandoor, Andaman & Nicobar, Portblair.
- Interpretation Centre at Nandurmadhmeshwar Wildlife Sanctuary, Nashik.
- Interpretation and Orientation Centres for Pench Tiger Reserve, Maharashtra

### National Green Corps

CEE has been the Resource Agency (RA) in fifteen States and two Union Territories and covers around forty thousand schools through this country wide awareness programme initiated and funded by the Ministry. Various activities including training of master trainers, developing and distributing educational material, conducting workshops and observing environmentally significant days like Earth Day, Wildlife Week, etc. were undertaken.

District level orientation and training programme for eco-club teachers were also conducted in different states. CEE Jaipur with Rajasthan Bharat Scouts and Guides conducted one day district level Prakriti Mela at Jaipur on 7<sup>th</sup> November. CEE also facilitated a State level Eco Fair in Rajasthan from 17 - 18 July 2009.

### SAYEN

CEE hosts the Secretariat and the India National Focal Point for the South Asia Youth Environment Network (SAYEN), supported by UNEP – Regional Office of the Asia and the Pacific (ROAP). The 6<sup>th</sup> TUNZA SAYEN Regional Meet was organised on 16-19 November at Colombo, Sri Lanka. The meet was hosted by CEE Sri Lanka and was jointly conducted by CEE India, the SAYEN Secretariat, and UNEP ROAP.

CEE's "Prakriti - Environment Education Bus" was opened for display at various events in Ahmedabad and Surat. As part of Energy Education in Primary-teacher Training Colleges, a joint initiative of the Gujarat Energy Development Agency and CEE, workshops have been organized in twenty five PTC colleges in five districts of Gujarat. Also, about ninety volunteering or internship opportunities were provided in projects and activities related to sustainable development.

### TechMODE

CEE initiated *GRAMDOOT*, under the TechMODE (Technology Mediated Open and Distance Education) project to strengthen Open and Distance Learning through mobile and other media, in Rajkot district of Gujarat. The project aims to promote information empowerment and livelihood security of the rural poor and the poorest.

### Saral Shiksha – Making Education Simpler

CEE has signed an MoU with UNICEF Gujarat for a project to develop an interactive multimedia learning pack. In many government primary schools, the number of classes or sections is often greater than the number of teachers; for instance, three

teachers for a school with classes from first to seventh. This makes situation hard for both teachers and the students. Under Saral Shiksha project, CDs comprising animated, interactive software that will help students learn hard spots from Science and Mathematics textbooks of classes fifth to seventh would be developed.

### Sustainable Development through NREGA

CEE has initiated projects on integrating Sustainable Development perspective in implementation of National Rural Employment Guarantee Scheme, in different States of the country.

### Publications

- CEE North has trans-adapted 'Disha' the handbook for National Bal Bhavans and National Green Corps (NGC) eco-club facilitators into Hindi. The booklet is titled *Kar Dikhaein Kuch Aisa Shamil Kar Sabhi Ko* (Let's do and show, with everyone's participation). The book aims to provide orientation towards Education for Sustainable Development.
- *A Trip With Drip: The Water Drop* has got its fourth language version with the book being published in Turkish. The Turkish version titled *Su Damlasi Sipsip ile Bir Gezi* was recently published by publishing house Caretta. Ten thousand copies of the book have been distributed free of cost to selected primary schools across Turkey.
- CEE brought out the Indian Edition of *State of the World Report 2009*, which is focused on Climate Change. State of the World Report published annually by Worldwatch Institute, Washington, has been a benchmark for discussions on various issues

of sustainability and the annual volume acts as a platform to launch further discussion, study, and research.

- CEE adapted and produced *Facilitators and Trainers Guide Book* on human values based water, sanitation and hygiene education.
- A hand book for Coastal Mangers, '*Towards Safe Coasts Integrating Disaster Risk Reduction into Coastal development in India*' was brought out by CEE.
- CEE developed '*We Hold our Future*', a sub-regional sustainable development strategy for South Asia – a youth perspective.

## C.P.R. Environmental Education Centre (CPREEC)

### Introduction

C.P.R. Environmental Education Centre (CPREEC) is a Centre of Excellence of the Ministry of Environment and Forests, Government of India, jointly set up by the Ministry and the C.P. Ramaswami Aiyar Foundation. The main objective is to create awareness among various stakeholders about current environmental issues and responsibilities towards the preservation of our environment. The programmes are conducted in the states of Andhra Pradesh, Goa, Karnataka, Kerala, Orissa, Maharashtra and Tamilnadu and the Union Territories of Andaman and Nicobar Islands and Pudhucherry.

### Progress /achievements made during the year

- CPREEC's Green School Initiative (GSI), launched in 2007 in Chennai, Bengaluru, Hyderabad and Ooty, was expanded to include more schools and two more places– Mysore and Puducherry. This scheme

- involves students in environmental management in five areas: reducing energy and water consumption, waste management, greening the campus and animal welfare. This programme has been hugely successful in converting awareness and education to action. Awards were given to the best GSI schools in Chennai, Bengaluru and Hyderabad.
- Teachers selected by the state Departments of Education in the states of Andhra Pradesh, Karnataka, Kerala, Goa, Orissa, Maharashtra and Tamilnadu were trained to teach environmental studies in line with the new syllabus and textbooks. Resource materials to supplement class work were distributed to all participants.
  - Special workshops on Environmental Education for Sustainable Development targeted state government textbook writers who will include the subject in future textbooks.
  - To extend the scope of environmental education, Kompassionate Kids - a project funded by the Winsome Constance Kindness Trust, Australia and the C.P. Ramaswami Aiyar Foundation – was launched to teach children about the link between their food and environmental damage as well as the importance of kindness to animals. A CD on “Eating Up the World” was produced and distributed to NGOs and schools, accompanied by relevant literature.
  - CPREEC organized programmes on waste management for rural sanitary workers in handling, segregating and composting waste. The various laws that govern biomedical waste management were included.
  - Disaster management programmes for coastal communities focused on planting shelter belts to mitigate the impact of cyclones and floods that repeatedly attack the east coast of India.
  - The species approach to biodiversity conservation has been very popular with teachers and students in Andhra Pradesh, Karnataka, Tamilnadu and Puducherry. The focus was on Project Tiger, Project Elephant and Wetlands. The participants visited reserved forests and planned campaigns about the importance of biodiversity conservation.
  - CPREEC trained several NGOs and villagers in preparing People’s Biodiversity Registers by applying the Quadrat survey method. The Biodiversity Register of each village is maintained by the local NGO and/or villagers.
  - CPREEC has been conserving and restoring sacred groves since 1993-94. Eight groves are taken up for restoration each year. Sacred groves are the hub for village meetings and school visits that are devoted to proactive conservation plans. All activities are implemented with the participation of local villagers. Saplings are distributed to local students. Forty five sacred groves have been restored since 1993 and handed over to the local communities.
  - CPREEC trained women of thirty villages in waste management, vermi-composting, organic gardening and health and nutrition. Saplings and seeds were distributed to the participants and seed banks of local varieties were established in twenty villages.
  - The definition and importance of the Nilgiris Biosphere Reserve was conveyed to the

Village Forest Committees and Panchayats in the districts of Nilgiris, Coimbatore and Erode in Tamilnadu, Chamarajnagar in Karnataka and Wayanad in Kerala.

- The success of the CPREEC's Anti-Plastic campaign conducted in Ootacamund for the last four years prompted the District Authorities to extend it to Coonoor, where CPREEC launched the campaign at the annual Fruit Show at Sim's Park. Exhibitions on the Tiger and Nilgiri Biosphere Reserve were put up in several places, including Mudumalai and Bandipur Tiger Reserves.
- Forest guards, nursing trainees and teacher trainees were chosen for programmes on the importance of the island ecosystem and disaster preparedness. CPREEC's exhibition on Biodiversity and Climate Change was exhibited in several places.
- Four issues of the quarterly newsletter ECONews were brought out. Two of the issues dealt with a specific topic: Climate Change and Natural Heritage Sites of India.

### Generation and Production of Resource Materials



A booklet on *Nilgiris Under Attack* (English), *Tiger! Tiger!* (in Malayalam, Telugu and Tamil) and *Climate Change* (in English and Tamil) were also published. A textbook on *Climate Change*, books on *Biodiversity*, *Disaster Management* and *Solid Waste Management* (in Telugu) and a *Training Manual on Bio-Medical Waste Management* were also published.

- Appropriate resource materials produced by CPREEC were distributed to the participants of the various training programmes organised in the states of Andhra Pradesh, Goa, Karnataka, Kerala,

Maharashtra, Orissa, Tamilnadu and the Union Territories of Andaman & Nicobar Islands and Puducherry.

- CPREEC collected and analysed one hundred fifty water samples along the Chennai coast to compare the level of intrusion. Water was collected from fifty localities along the Karaikal coast to study salt water intrusion. CPREEC also carried out ambient air quality, noise level and soil surveys at Pollachi in Coimbatore district. At Gudiyatham in Vellore District, ambient air and noise level surveys were carried out. The water quality of Tiruchirapalli was also analysed. In collaboration with a school in Kanchipuram district, CPREEC carried out an ambient air quality and noise survey near a crushing unit to study the pollution caused by noise and dust particles. Water samples of the residential areas were also analysed. All the above were carried out in response to requests made by local communities.
- CPREEC's ENVIS Centre on Conservation of Ecological Heritage and Sacred Sites of India has expanded the existing database on various aspects of Indian ecological heritage with primary and secondary sources. The Bi-Annual ENVIS newsletter *ECOHERITAGE.COM* was published in the prescribed format.
- Being the Regional Resource Agency (RRA) for the states of Andhra Pradesh, Karnataka, Kerala, Goa, Orissa, Tamilnadu and Union Territories of Andaman & Nicobar Islands and Puducherry), CPREEC convened a meeting of the above Nodal Agencies at Chennai to discuss the functioning and the modalities of the NGC. Workshops were organised for NGC teacher-coordinators

- in the states of Andhra Pradesh, Karnataka, Kerala, Orissa, Tamilnadu and Union Territories of Puducherry and Andaman & Nicobar Islands.
- CPREEC structured a series of workshops on Bio-medical Waste Management for Medical Officers in the states of Andhra Pradesh, Karnataka, Kerala, Tamilnadu and the Union Territory of Puducherry. The workshops were executed in collaboration with the State Pollution Control Boards and the Indian Medical Association. A *Manual on Bio-medical Waste Management* was specially prepared and distributed to the participants. The workshops were sponsored by the Ministry of Environment and Forests, Government of India.
  - A series of workshops on Solid Waste Management was organized in the states of Andhra Pradesh, Tamilnadu and the Union Territory of Puducherry for Corporation and Municipality solid waste managers and elected members of the Panchayat. The workshops sponsored by the Ministry of Environment and Forests, Government of India were conducted in collaboration with the concerned district Municipal Corporation.
  - In collaboration with the US Consulate General, Chennai, CPREEC organised the Earth Day lecture on *Climate Change and the Future of Wetlands* by Dr. Beth A. Middleton, Research Ecologist, National Wetlands Research Centre, Lafayette, USA.
  - A Round Table Discussion on *Biodiversity and Invasive Alien Species* was organised at Chennai to mark the International Biological Diversity Day. The panelists included Ref. Fr. Dr. S. Ignacimuthu, Director, Entomology Research Institute, Loyola College, Chennai, Dr. K. Rema Devi, Scientist-E & Officer in Charge, Marine Biological Station, Zoological Survey of India, Chennai, Dr. Sultan Ahmed Ismail, Director, Ecoscience Research Foundation, Chennai and Dr. D. Narasimhan, Reader, Department of Botany, Madras Christian College, Chennai.
  - CPREEC brought out a sticker to highlight the importance of climate change and organised a sticker campaign at Chennai. The staff of CPREEC distributed stickers to motorists at important traffic junctions.
  - Dr. M.S. Swaminathan, Chairman, CPREEC, gave away the annual C. P. R. Environmental Education Centre Award for Environmental Education - 2009 to Shri. Rajendra Pandurang Kerkar, a teacher from Goa, in recognition of his contribution to environmental conservation through education.
  - CPREEC organized GLOBE programmes in sixty schools in Puducherry. The schools were provided with GPS Coordinates and equipments like water gauge, minimum / maximum thermometer, pH meter, cloud chart. The schools were trained to take readings on the rainfall, min/max temperature, cloud patterns and pH of water.
  - A pamphlet and stickers on Climate Change were distributed to NGOs and educational institutions implementing NEAC in select districts in Tamilnadu, Andaman & Nicobar Islands and Puducherry. A pre-NEAC workshop was organised in Puducherry on January 19, 2010. Tree saplings were also distributed to schools in Kanchipuram and Villuppuram districts.

## Centre for Ecological Sciences (CES), Indian Institute of Science (IISc), Bengaluru

### Introduction and Objectives

The Centre for Ecological Sciences (CES), Indian Institute of Science (IISc), Bengaluru was established in 1983. The CES, IISc conducts research and undertakes education and training in the broad area of ecology with special emphasis on the Western Ghats. The Union Ministry of Environment and Forests recognized the Centre of Ecological Science, Indian Institute of science, Bengaluru as a Centre of Excellence in the year 1983. The CES, IISc conducts basic research with practical application in conservation and sustainable development of natural areas of Western Ghats and other regions of the country, and organizes extension and training programmes particularly for field managers.

### Activities undertaken so far

The Centre for Ecological Sciences carried out thirty research projects in the fields of ecology of tropical forests, climate change, community ecology, behavioural ecology and evolutionary biology. The centre also contributed to several initiatives of the Ministry of Environment & Forests including the Expert Panel on Climate Change and wildlife conservation programmes such as the National Tiger Conservation Authority and the Committee on Rationalization of Boundaries of National Parks and Sanctuaries.

### Progress and achievements during the year

#### – Tropical forests and climate change

Centre's work on tropical forest structure, dynamics and the influence of climatic

factors involves long-term monitoring of permanent plots in tropical forests of Western Ghats, mainly the Nilgiris and Uttara Kannanda districts. Natural vegetation, plantations and soils have been known as major carbon sinks. Analysis of a nineteen year data set from a fifty hectare plot in Mudumalai indicated that drought enhances tree mortality with a time lag of one to three years, but that tropical dry forests have better adaptive capacity compared to tropical moist forest and temperate forests. The results also indicate that the tropical dry and moist deciduous forests of the Western Ghats continue to act as carbon sinks in spite of disturbances such as fire and drought. More specifically, the Centre have been focusing on the ecology of the invasive species *Lantana camara*, its response to climatic factors and it's impact on native plant and animal communities. Rainfall and fire both play significant roles in the spread of this invasive plant.

#### – Community ecology and biogeography of select vertebrate taxa in the Western Ghats

The biogeography of herpetofauna in the Western Ghats is of particular interest given the high endemism and ancient origin of several families. The Centre is studying the biogeography of these groups using a combination of primary data, landscape ecology, modelling and molecular genetic tools to recreate phylogenies which provide clues about routes of dispersal and other mechanisms that result in current distribution patterns. Work has also been initiated on the community ecology of birds, on mixed species foraging flocks, and on distribution patterns of vertebrates.

– Coastal and marine biology and its conservation

Five of the seven species of marine turtles are found in Indian coastal waters and at least four have significant nesting beaches and/or feeding areas. The Centre is continuing molecular genetic studies of these turtles to explore phylogeography and population genetics, and studying other aspects such as multiple paternity. The Centre is also initiating tagging and telemetry studies for leatherback turtles in the Andaman and Nicobar Islands. The Centre is a long term population monitoring programme for mass nesting populations of olive ridley turtles in Orissa, and the potential impact of climate change on sea turtle populations through its impact on sex ratios. The Centre has also initiated projects on the diversity and distribution of coastal and marine invertebrates. We are studying the biogeography of these groups using a combination of primary data, landscape ecology, modelling and molecular genetic tools.

– Biodiversity and Conservation

Over the past year, The Centre has completed study on bat diversity in Kudremukh National Park. A total of twenty bat species have been identified to date. Of these, sixteen species belonged to the Microchiroptera (insectivorous bats) and four to the Megachiroptera (fruit-eating bats). Of the forty one species of bats reported so far from the Western Ghats, twenty (almost 50%) were found in Kudremukh National Park. Of the sixteen echolocating insectivorous bat species, the centre obtained call recordings of thirteen

species. The Centre also completed studies on vegetation structure and microhabitat selection by the cricket community of Kudremukh National Park. The results show strong microhabitat selection by most of the cricket species:

– Behavioural ecology of large mammals

A project on behavioural flexibility in large mammals focuses on the threatened blackbuck antelope *Antilope cervicapra* and uses a behavioural ecological framework to understand the responses of individuals and thereby the population to changing environmental conditions. The ecological basis of space use, foraging and social behaviour is being studied in a typical fragmented grassland landscape. The consequences of these behavioural traits towards crop damage and conflict with agriculturalists is also being studied. Initial results indicate that there is extensive variation across habitats and within each habitat in blackbuck use. The occurrence of crop damage is very localised and the factors predicting this occurrence are being explored. The Centre's work on Asian elephant behaviour and ecology also continued with new research on reproductive behaviour of the species in Kaziranga National Park with special emphasis on female choice of tusked versus tuskless males.

– Molecular ecology

In the past year, a number of projects have been completed, including Phylogeny and biogeography of tarantula, Evolutionary origin of scolopendrid centipedes and Molecular evidence for out-of-India hypothesis.

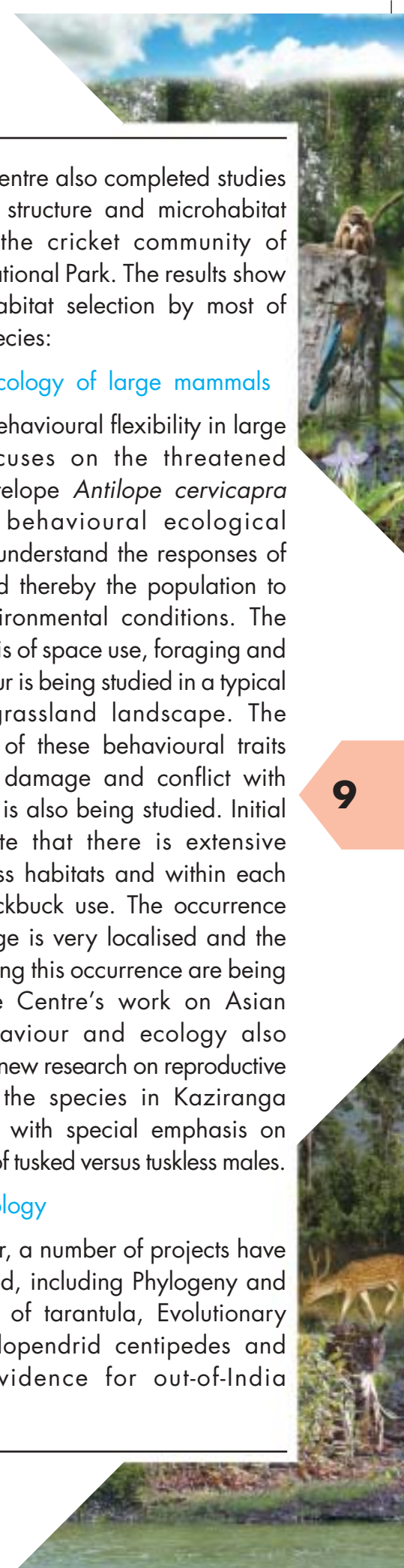

– Social Behaviour of Insects

The past year the Centre has used the methods of network analysis to conduct a study entitled “A comparative social network analysis of wasp colonies and classrooms: Linking network structure to functioning”. A major question in current network science is how to understand the relationship between structure and functioning of real networks. The Centre conducted a comparative network analysis of forty eight wasp and thirty six human social networks. The Centre has compared the centralisation and small world character of these interaction networks and have studied how these properties change over time.

– Chemical Ecology of Species Interactions: Plants, Insects, and other Invertebrates

The interactions between figs (*Ficus* spp., Moraceae) and their associated fig wasps (Hymenoptera: Chalcidoidea: Agaonidae) have been a subject of much interest to evolutionary biology as being a model system for studying co-evolution. Their studies on *Ficus racemosa* in India have shown that ants can eavesdrop on the chemical signals emitted by fig trees to attract their pollinating wasps. This is the first evidence of eavesdropping by ants on a plant odour.

– Visual Ecology of Species Interactions

The Centre studies have shown that crab spiders (*Thomisus* sp.) hunting on *Spathiphyllum* plants use chromatic contrast, especially UV contrast, to make themselves attractive to hymenopteran prey. Apart from that, they are able to achieve high UV

contrast by active selection of non-UV reflecting surfaces when given a choice of UV-reflecting and non-UV reflecting surfaces in the absence of odour cues. Honeybees (*Apis cerana*) approached *Spathiphyllum* plants bearing crab spiders on which the spiders were high UV-contrast targets with greater frequency than those plants on which the UV contrast of the spiders was low. Thus, crab spiders can perceive UV and may use it to choose appropriate backgrounds to enhance prey capture, by exploiting the attraction of prey such as honeybees to UV.

**Centre for Mining Environment (CME), Indian School of Mines, Dhanbad**

The Centre of Mining Environment (CME), Dhanbad is a Centre of Excellence since 1987 under the Ministry's Grants-in-Aid (Plan) Scheme – Centres of Excellence in the field of mining. The Centre has been mainly engaged in R&D activities and the associated research publications, and in defining envl safeguards for mining, training personnel in mining sector and involved in issues of academic interest pertaining to mining and environment. It is proposed to review the Centre's role and activities as a Centre of Excellence for further release of funds.

**Salim Ali Centre for Ornithology and Natural History (SACON), Coimbatore**

Objectives

The Salim Ali Centre for Ornithology and Natural History (SACON) was established in 1990 in Coimbatore as “Centre of Excellence” of the Ministry. The main objectives of the Centre is to design and



conduct research in ornithology covering all aspects of biodiversity and natural history.

### Activities

The research projects undertaken during the year 2009-10 deals with a variety of specialized topics related with species-specific studies, studies on associated species, those relating to ecosystems/habitats, community ecology, impact assessment, and environmental contamination. SACON continued with the Environmental Information System (ENVIS) programme on wetlands, and its nature education programme intensively during the period.

### Major activities undertaken

- Species specific studies on bird that included a study on 'Ecology and Conservation of the Spot-billed Pelican' a globally threatened species, in Andhra Pradesh. The *in-situ* and *ex-situ* conservation programme for the Edible-nest Swiftlet *Collocalia fuciphaga* in the Andaman & Nicobar Islands are continued and have resulted in very encouraging results. In the Andaman & Nicobar Islands, further to the earlier study on the impact of the 2004 Tsunami, a project to monitor the post-tsunami coastal ecosystem recovery to identify if necessary and develop site-specific restoration measures has been initiated.
- Information on pollution and seed dispersal is very handy in developing cost-effective afforestation programmes and habitat conservation. A study in this line in the dry deciduous forests in Southern Eastern Ghats



Fig-41. Golden Bush-Robin (*Tarsiger chrysaeus*) found in Himalayas and north-east India

and dry evergreen and shola forest ecosystems of Tamil Nadu was undertaken upon the requirement by the Tamil Nadu Forest Department. A study on Ecology of Indian Grey Hornbill, *Ocyrceros birostris* brings out the critical role played by the species in seed dispersal in Southern Eastern Ghats.

- The Study on 'adaptation and tolerance of birds to urbanization with emphasis on life strategy' funded by the International Foundation for Science (IFS, Sweden) looks at the bird species, nest success and abundance along a rural-urban gradient. The study aims at bringing out the underlying ecological principles and behavioural adaptation of avian species. A study focussing on house sparrows in view of urbanization and environmental transition is in progress in Coimbatore. The study also examines the population changes of the species with special reference to the ecological and environmental threats to the species.
- One of the major aims of SACON is to develop community participation in

conservation actions. SACON's programme in Nagaland, in collaboration with Nagaland Empowerment of People through Economic Development (NEPED), a local organization, is meant to impart technical support on biodiversity conservation and livelihood options to local Communities and to promote development of community conservation areas in the state.

- Study of other species associated with important habitats is also crucial for identifying required conservation measures. Our study on ecology of the Endangered Indian Rock Python in Keoladeo National Park, a world famous bird sanctuary and a world heritage site, focuses the population structure, ranging pattern, food and breeding habits and cohabiting animals with python. It aims at revealing the role python plays in the park system. Such information will be very handy to improve the management interventions. Another such study looking at the herpetofaunal communities of the Upper Vaigai Plateau (Western Ghats) documented the ecology and distribution of thirty four species of amphibians and seventy two species of reptiles in the area.
- SACON has completed a study 'Inventory of the biodiversity of Attappady with GIS aid' in collaboration with the Attappady Hills Area Development agency, and documented the distribution of major components of biodiversity to help in developing strategies for management and ecological restoration of the area. Another GIS based project undertaken during the last year is 'Inventorisation of wetlands' in North Kerala which aims at wetland mapping and inventory, identification of

important wetlands for conservation and preparation of a district wise wetland atlas.

- SACON has continued its works related to Environmental Impact Assessment. A study on the conservation of Kottuli Wetlands (Kerala), one of the wetlands of national importance, was undertaken in view of the proposed ecotourism project there. SACON also undertook a study on the Mumbai Trans Harbour Link (MTHL) a major infrastructure project built by Mumbai State Road Development Corporation (MSRDC) focusing on flamingos and migratory birds. The study focuses on a stretch of about five kilometers over Sewri and Nhava including the mudflats that is an important Bird Area (IBA) identified by the Indian Bird Conservation Network. The area harbors a large population of waders and good proportion of the south Asian population of the Lesser Flamingo (*Phoenicopterus minor*), a Near Threatened species. The study identifying various threats to birds in the project area came up with conservation oriented recommendations to manage the bird habitats.
- As part of ecotoxicological investigations on birds, a study on Impact of agricultural pesticides on the population status and breeding success of certain fish-eating birds in Tamil Nadu was taken up.
- As part of nature education programme SACON reached out to thousands of students and public during the current year. The routine Nature Education programmes such as guest lectures, one-day nature camps and wetland day/forestry day celebrations were organized. Several one-day nature camps, Salim Ali Trophy Nature Competitions 2008-09, Nature camp for

mentally challenged children, Environmental Awareness for college students, and Vatavaran Film Festival were some of the major events. The Salim Ali Nature Forum promoted by SACON has also become a partner in DBT's Natural Awareness Clubs for Andamans.

- Recruitment process has been completed for filling up four posts of scientists.

### **Centre for Environmental Management of Degraded Ecosystems (CEMDE), University of Delhi, Delhi**

- The Centre of Excellence Programme of MoEF at the Centre for Environmental Management of Degraded Ecosystems (CEMDE), University of Delhi, has been actively involved in (i) development of ecological restoration technologies for ecosystem redevelopment in degraded landscapes including mined out, desertified and degraded forest lands and (ii) in the management of invasive weeds that led to loss of biodiversity in forest ecosystems. The scientists have developed site specific restoration technologies which have been successfully implemented for the restoration of limestone mined out areas, Iron ore mined out areas, morrum mined out areas and degraded Aravalli hills to the original forest ecosystems, and these technologies are used by the stakeholders today. The restoration technologies involve appropriate assemblage of plant species and their associated microbes and soil invertebrates, and inoculation procedures. The restoration technologies developed are simple, cost effective, does not require after care, and generate employment among rural women.

- A *New Management Strategy for eradication of Lantana* – one of the top ten world's worst weeds and an alien that invaded tropical and subtropical India and threatening native biodiversity involves (i) removal of *Lantana* by cut rootstock method – a simple, innovative and cost effective method developed by the scientists of the programme; (ii) weeding out of saplings/ young plants from beneath the perching trees of generalist birds, which disperse the seeds, by using Search List of Perching Trees of Generalist Birds; and (iii) restoration of weed free landscape to the grassland/ forest communities.

- The new management strategy has been widely followed for eradication of *Lantana* by many states across the country. In Corbett Tiger Reserve alone, *Lantana* was eradicated from one thousand seven hundred hectares and restored weed free landscapes to the grasslands which are now used by herbivores, and the frequency of Tiger sighting has been increased several fold in weed free restored sites.

- The Centre is to augmented capacity building in action research through seminars/ workshops to stakeholders. The scientists have been conducting a series of interface programmes to officials and field staff of the forest departments of different states and NGOs.

### **Madras School of Economics, Chennai**

#### **Introduction and objectives**

The Centre of Excellence in Environmental Economics was set up on the basis of a MoU in 2002 between the Ministry of Environment & Forests and the Madras School of Economics. The MoU was extended

in 2008 for the duration of 11<sup>th</sup> Five Year Plan. The objectives of the Centre are to carry out research on issues related to environmental economics in project mode, maintain a state-of-the-art website on environmental economics and provide policy assistance to the Ministry. During the year 2009-10, the Centre continued its work on the ongoing projects on trade and environment inter-linkages with special focus on textile sector, and integrating eco-taxes in the emerging GST regime. The Centre has initiated a bi-annual newsletter, 'GREEN THOUGHTS'.

### Environmental Economics Website

The Centre's website <http://coe.mse.ac.in> has been redesigned with the new state-of-the-art website by making it more user-friendly. Efforts have been made to augment the database on environmental economics literature substantially. Similarly a number of Indian studies have also been added to the database. The website is serving as one-stop destination for researchers, Policy makers and other stakeholders interested in environmental economics related issues in India.

### Studies/Projects

- 
- The Centre has completed the project on, 'Coping with Pollution in India with Eco-Taxes: Integrated Approach Consistent with GST Regime'. A draft discussion paper has been submitted to the Ministry in 2009.
  - The Centre is finalizing the project, 'Trade and Environment: India's Export of Textile and Textile Products and Environmental Requirements', addressing, *inter-alia*, issues like: status of pollution abatement in textile industry in India, trade competitiveness of Indian textile industry, assessment of pollution abatement costs in textile industry

(with focus on textile processing), and linkages between pollution abatement and textile trade.

- Newsletter Launched: A bi-annual newsletter of the Centre of Excellence "Green Thoughts" was launched to update readers on the work being carried out at the Centre. Two issues of newsletter were published during the year. Each issue carries perspectives of experts on the specific theme of the newsletter.
- Dissemination papers were brought out by the Centre during the year on:
  - (i) Eco-system Services, and (ii) Climate Change and Adaptation
- The Centre provided policy inputs to the Ministry as and when required including inputs for Union Budget 2010-11.

### Programme on Trade and Environment

The Ministry has sanctioned a three-year consultancy project, 'Programme on Trade and Environment' from December, 2006. Under this programme, a dedicated website – <http://www.mse.ac.in/trade/index.asp> has been designed and launched during the year. The website functions as one-stop resource for Trade and Environment related issues in India with comprehensive coverage of Doha development agenda, General Agreement on Trade in Services, Regional Trade Agreements, Trade-Related aspects of Intellectual Property (TRIPS), and Trade and Environment in the context of World Trade Organization (WTO).

### Foundation for Revitalization of Local Health Tradition (FRLHT), Bengaluru

The Centre of Excellence on Medicinal Plants and Traditional Knowledge at FRLHT,

Bengaluru was initiated during 2002-03 to bring to the focus and address the various issues related to conservation and sustainable utilization of medicinal plants. In the course of its activities, the Centre has created a national Bio-cultural herbarium of medicinal plants and an ethno-medicinal garden, both of which have very rich collections of Medicinal plants. Besides, the Centre engages in: a) pharmacognostic studies on the controversial plant raw drug groups in trade, b) building capacities of different stakeholder groups about various issues related to medicinal plants, through its capacity building courses, workshops and training, c) preparing a GIS based Atlas of distribution maps of medicinal plants to help forest managers in planning conservation action, d) Well-referenced educational CD-ROMS on medicinal plants used in Siddha, Unani and Homoeopathic systems of medicine.

#### Progress/achievements during the year

– Development of unique Bio-cultural Herbarium of Indian Medicinal Plants was one of the key tasks. Towards this end, the botanical team of the centre engaged in floristic surveys in different locations of Tamil Nadu, Rajasthan, Goa, Gujarat, Nagaland and Dibang valley in Assam, which resulted in the collection of about four hundred specimens of one hundred species. Further to this, about one thousand specimens were added to the Herbarium in order to strengthen the representation of the morphological variations of medicinal plant species.

In order to make the collection at the Herbarium more Education friendly, the



Fig-42. *Dactylorhiza hatagirea*, a high-valued medicinal orchid, commonly known as 'Salem Panja' or 'Hatajari'

collections were grouped around ten select themes. Further, about one thousand five hundred images of plants including their medicinal parts and habitat, and scanned images of about eight hundred Herbarium sheets were added to the image library in an attempt to make it into a Virtual one. During the year, about eight hundred samples procured from different markets across the country were added to Raw drug repository.

The team also took up a Status survey of wild populations of *Saraca asoca* across select locations in West Bengal, Orissa and Khasi hills and prepared a Status report.

– The collections at the Ethno-medicinal garden were further diversified by adding

more theme, viz., Narcotic and poisonous plants, Plants for enhancing water quality.

- The Phyto-chemical screening, DNA extraction, rRNA sequence based molecular identification of various "Daruharidra" samples was completed. Besides, Species-specific markers for each "Daruharidra" species were developed. A Monograph on "Vidanga" group of plant drugs has been finalized and printed. Another Monograph on "Vidari" group of plant drugs has also been drafted.

- The Geo-distribution maps for two hundred fifty species and Eco-distribution maps for twenty five species were prepared. The revised and upgraded version of Digital Atlas, incorporating Geo-distribution and Eco-distribution maps has been completed.

Additionally, a review note on the current status of recording and reporting of exports and imports of medicinal plants was also prepared.

- Two National level workshops on "Strategy and Guidelines for Conservation of Medicinal Plants in India" were conducted which resulted in the consolidation of the Strategy and Guidelines. Six capacity building courses on "Medicinal Plants Conservation" for the Front line staff of Rajasthan, Gujarat and Chhattisgarh were organised in which more than two hundred thirty field staff were trained. Two TOT courses on "Medicinal Plants Conservation" were organised for the Faculty from the Forestry Training Institute, in which about twenty five faculty member were trained.
- A prototype CD-ROM on the "Plants in Sushruta Samhita" was prepared and sent for a peer review. Similarly, prototype of

the CD-ROM on "Plants in Ashtanga Sangraha" was prepared.

## **Tropical Botanic Garden and Research Institute, Thiruvananthapuram**

### **Introduction and objectives**

Tropical Botanic Garden and Research Institute (TBGRI) was established by Government of Kerala as an autonomous R&D organization in 1979 to facilitate conservation and research on tropical plant resources in general and of the country and the Kerala state in particular. The institute is located at about forty kilometer northeast to Thiruvananthapuram city and maintains a three hundred acre conservatory garden for the wild tropical plant genetic resources of the country, besides a well integrated multidisciplinary R&D system dealing with conservation, management and sustainable utilization of tropical plant resources. The Institute was brought under the society established by the State Government namely "Kerala State Council for Science, Technology and Environment" (KSCSTE) in 2003.

The Institute was recognized as a National Centre of Excellence in *ex-situ* conservation of tropical plants and a number of research projects as referred below were successfully implemented by the institute.

- Introduced over one hundred thirty accessions including trees, medicinal plants, bamboos, palms etc to the living plant collection. Twenty five species of palms and twenty species of ferns introduced from highlight of this collection.
- Database on two hundred twenty Plant species of the Western Ghats developed and a manuscript in Ethnobotany was revised.

- More than one thousand two hundred collections of lower Fungi organized, common fungal pathogens of twenty two *Vanilla* Plantations were collected from different parts of Kerala.
- About one hundred forty Macro - lichens and one hundred micro lichens were collected, thirty seven species were found to be new records.
- Pollination and seed cryobanking of two horticulturally important orchids was developed.
- Hairy root cultures of *Rauwolfia micrantha* were found to contain significant quantities of the anti-hypertensive agent, Ajmalicin.
- Partial c-DNA of tyrosin carboxylase gene involved in L-DOPA synthesis was isolated and characterized.
- Genetic diversity was estimated in thirteen accessions of *Mucuna pruriens* (L.) DC.
- Insect repellent property of certain plants of the Andaman islands was analysed and development of Bee and Mosquito repellent formulation is in progress.
- Potential molecules having flavouring, fragrant and anti-oxidant properties isolated from selected plants. At least four international publications were made out of these.
- As part of chemical prospective of plants, biological molecules of *Curcuma*, *Thottea* and *Pittosporum* species were characterized.
- An active coumarino – lignoid compound involved in stimulating water and electrolyte absorption in intestine was identified.
- Proteins isolated from an active fraction, involved in anti-stress activity of *Trichopus zeylanicus* were isolated and are being characterized.
- Analgesic and anti-inflammatory studies on the plant extract (*Justicia genderossa*) is completed.
- The antidiabetic property of *Pilea microphylla* and the wound healing property of *Glycosmis pentaphylla* has been confirmed in animal models.
- One thousand six hundred, herbarium specimens were processed and ninety species of plants were collected and taxonomically identified.
- Reproductive biology of *Impatiens dassysperma* was critically studied.
- Nine hundred thirty two collections were added to mushroom herbarium.
- Draft of the Children's Handbook on Medicinal and Food Plants (1st volume) prepared.
- Herbs for all and Health for all: awareness and training programmes completed in the Vithura Gramapanchayath. A trainer's manual (98 pages) prepared is under print.
- Collections of banana germplasm organized through people support from remote village
- Multiplied high value medicinal plants, distributed to beneficiaries and imparted training in nursery practices and cultivation at Kanjukuzhy Panchayath, Alappuzha district (One year project).
- A biodiversity awareness workshop organized for thirty delegates from Kollam Corporation; training on plant propagation imparted to seventy five Plus Two students during National Technology Day.

- Three popular varieties of banana (Nenthran, Robusta, Grand Naine) and ornamentals multiplied and distributed to the public to generate about Rs. 1.5 lakhs as income.
- Over twenty five thousand students and visitors visited TBGRI during the year and the message of conservation was effectively disseminated.

The Institute's garden was recognized as a Lead Garden for the region and necessary funds were provided for this purpose by the Union Ministry of Environment & Forests. The institute has established a park for rare species, which will serve as a demonstration plot. Propagation techniques for rare species and infrastructural facilities for eco education has been developed under the scheme. Further, as a Lead Institution for Biosphere Reserves of South India, the Institute has prepared status report of Augusthyamalai Biosphere Reserve for onward transmission to UNESCO.

### Centre for Animals and Environment, CARTMAN, Bengaluru

The project on Centre of Excellence for Animals & Environment (CAE) awarded by the Ministry to CARTMAN, Bengaluru in 2000 and discontinued after two years for administrative reasons was resumed during 2009.

The main objective of the Project is to study the mutual dependence and inter-relationship between the Animals (LIVESTOCK) and Environment (Plant Life) and initiate steps to preserve environment and to improve the health and welfare of animals by making them more productive.

#### Activities undertaken during the year

Compilation of data relating to the

scope of the project, Consultations with experts, study on the utilization of the bullock carts in two locations each in Karnataka and Tamil Nadu and the need for their modernization, Study of two slaughter houses in two locations in the cities of Karnataka or Tamil Nadu, preparation of Website and data bank, Conducting Audio Visual Programme on Environment for school children in Bengaluru City, Conducting Questionnaire Survey on the subjects of land availability, classification of land, availability of pasture land, forest land etc, population of livestock, their classification, trend in population, utilization of bullock carts in six States viz., Madhya Pradesh, Andhra Pradesh, Orissa, Maharashtra, Tamil Nadu and Karnataka were the activities taken during the year.

#### Study of Slaughter Houses in two locations in Karnataka

Work has already been taken up to study the slaughter of small and big animals in the districts of Belgaum and also of slaughtering animals for the City based abattoirs in Bengaluru.

#### Creation of Website and Data Bank

Work has already been started and this particular Website will be operational during the last quarter of the financial year 2010-11.

#### Audio Visual Shows

As a part of the Awareness Programme planned for the first year CAE completed twenty five numbers of Audio Visual Shows for various school children in the City of Bengaluru. Audio Visual shows conducted were on environment, conservation of ecology, bio - diversity, conservation of natural resources and pollution control.



**CHAPTER – 10**  
**FELLOWSHIPS AND**  
**AWARDS**

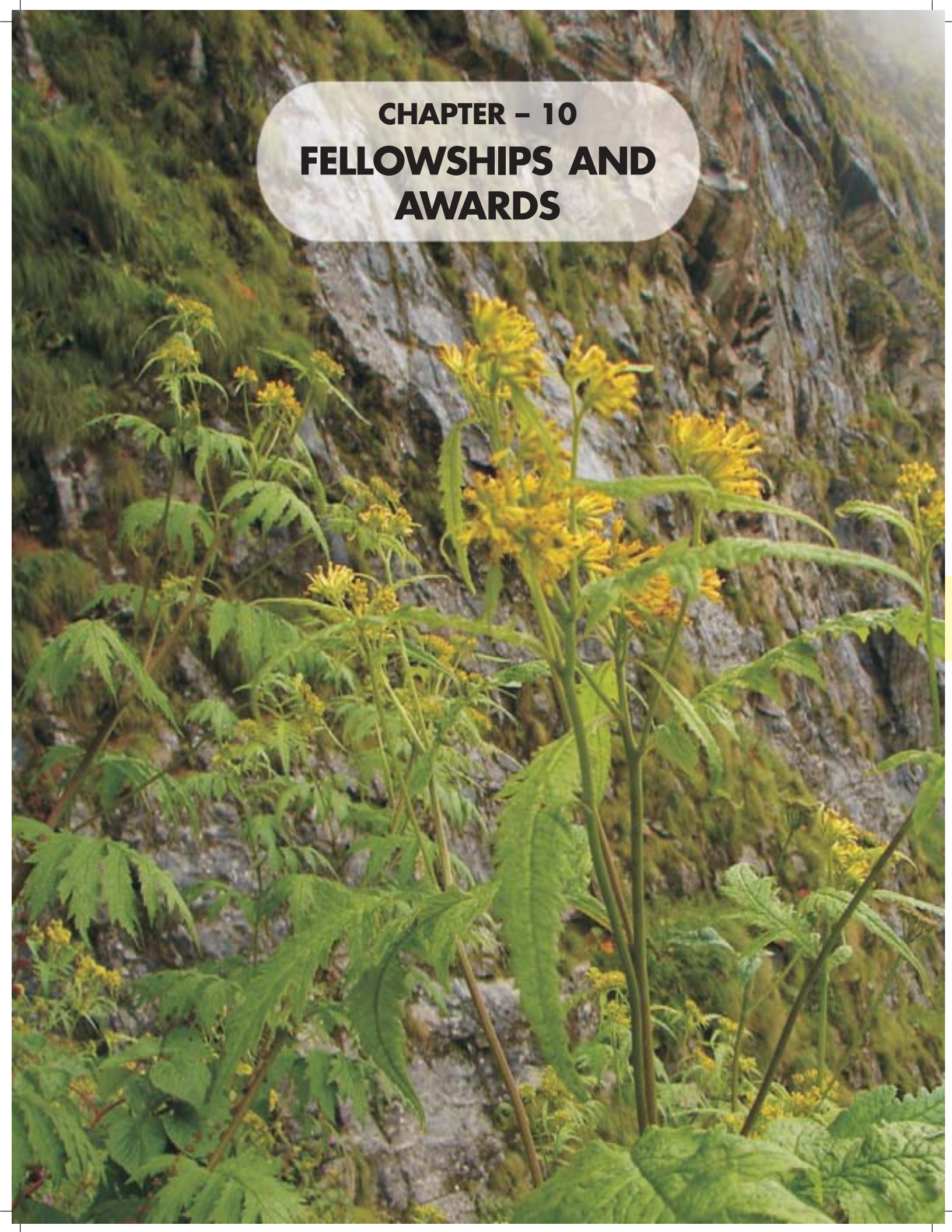

## Indira Gandhi Paryavaran Puraskar (IGPP)

### Introduction and Objectives

In reverential memory of late Prime Minister Smt. Indira Gandhi, the Ministry of Environment and Forests, in the year 1987, instituted an award called "Indira Gandhi Paryavaran Puraskar" to give recognition to those having made or have the potential to make the measurable and major impact in the protection of environment. In the beginning, a cash prize of Rs. 1,00,000/- was awarded to deserving individual/organization of India. Since 1991, the prize of Rs. 1,00,000/- each were awarded separately to individual and organizational category. From the year 2002, the prize money has been enhanced to Rs. 5,00,000/- in each category. Subsequently, the "Regulations" governing the IGPP was revised from the year 2005 onwards. As per the revised regulations, one prize of Rs. 5,00,000/- under the Organisation category, and two prizes of Rs. 3,00,000/- and Rs. 2,00,000/- each to individuals in the Individual category shall be given annually. The regulations governing the IGPP was again revised. As per the revised regulations from the year 2009 onwards, two prizes of Rs. 5,00,000/- each under the Organisation category, and three prizes of Rs. 5,00,000/- Rs. 3,00,000/- and Rs. 2,00,000/- each to individuals in the Individual category shall be given annually. Along with the cash prize, each awardee is given a silver lotus trophy and a citation. Any citizen of India or organization working in India for the cause of environment is eligible for the award. There is no age limit for the nomination for individual. Self nominations

are not considered. Short listing of the nomination is carried out by three Expert Members selected by the Prime Minister's Office. The environmental Prize Committee constituted under the Chairmanship of Hon'ble Vice President of India select the awardees.

While selecting the awardees the term "environment" is interpreted in the broadest sense possible and comprising of following areas of work:

- Prevention of Pollution.
- Conservation of Natural Resources.
- Rational use of depletable resources.
- Environmental Planning and Management.
- Environmental Impact Assessment.
- Outstanding field work (innovative research work) for enrichment of environment e.g. afforestation, land reclamation, water treatment, air purification etc.
- Environmental Education.
- Creating awareness of environmental issues.

The awardees for the Indira Gandhi Paryavaran Puraskar for the year 2006 and for 2007 were selected by the Prize committee under the Chairmanship of Hon'ble Vice President of India. The awards were given away to the awardees by Her Excellency Smt. Prathiba Devisingh Patil, President of India in the award ceremony held at Vigyan Bhawan, New Delhi on 5<sup>th</sup> June, 2009 on the occasion of World Environment Day.

The nominations received for IGPP-2008 were processed. Short-listing of the nomination was carried out by the three experts selected by PMO. The ground truth verification of the short-listed nominations was



Fig-43. Presentation of IGPP award by Hon'ble President of India on World Environment Day, 2009

carried out by the Regional Offices concerned of the Ministry. The Prize Committee in its meeting held on 20<sup>th</sup> August 2009, again short listed 6 nominations (3 in the individual category and 3 in the organization category) for further verification at field level by carrying out videography/ photography as appropriate. The ground truth verification along with photography/Videography of the 6 short-listed nominations was carried out by the Statistical Adviser, MoEF along with the regional offices concerned of the Ministry. The selection of the awardees have been done by the Prize Committee in its meeting held on 16<sup>th</sup> February, 2010.

Advertisements for inviting the nominations for IGPP, 2009 were issued in national dailies with regional coverage on 5<sup>th</sup> June and 20<sup>th</sup> July, 2009. The nominations

for IGPP-2009 under both the individual and organization category have been received. Various activities as per the regulations applicable for IGPP-2009 are under process.

### **Indira Priyadarshini Vriksha Mitra (IPVM) Awards**

The Indira Priyadarshini Vriksha Mitra (IPVM) Awards were instituted in 1986 to recognize the pioneering and innovative contribution made by the individuals and institutions in the field of afforestation/wasteland development every year.

Till the year 2005, the awards were given under twelve categories but from 2006 onwards the awards were restructured to enhance their response and prestige and now awards under four categories are given as follows:

## Ministry of Environment & Forests

1. Individuals including Government Servants
2. Joint Forest Management Committee (JFMC)
3. Institutions/ Organizations under Government
4. Non-Governmental Institutions/ Organizations

- Only one award is given in each category.
- Cash prize of Rs. 2.5 lakhs along with Medallion and Citation is given for each category.
- Nominations of Government servants/ Govt. Institutions/Organizations are forwarded through the Head of the Department/Organization concerned and those from JFMCs may be forwarded by the PCCF concerned.

The Awards upto the year 2006, 2007 and 2008 were conferred on 19<sup>th</sup> November 2009 and the same for the calendar year 2010 are under process.

### IPVM Awards for States and Union Territories

The IPVM Awards for States and Union Territories were instituted in the year 2008 for enhancing the percentage of Forest and Tree Cover in States/UTs. The awards are divided into three categories and only one award is to be given in each category as under:-

a) Big States having geographical area of 80,000 sq. km. and above.	Rs.8.00 lakhs (One)
b) Small States having geographical area below 80,000 sq. km.	Rs.5.00 lakhs (One)
c) Union Territories	Rs.5.00 lakhs (One)

The IPVM Awards for States/UTs were conferred upon on 19<sup>th</sup> November, 2009 and the same for the calendar year 2010 are under process.

### Pitamber Pant National Environment Fellowship

Pitamber Pant National Environment Fellowship instituted in 1978 is awarded every year to encourage and recognize excellence in any branch of research related to the environmental sciences. The fellowship is awarded every year and is in recognition of significant important research/development contributions and is also intended to encourage talented individuals to devote themselves to Research and Development (R&D) pursuits in



Fig-44. Hon'ble Minister of State (I/C) for Environment and Forests with an awardee of IPVM during the award presentation ceremony

the field of environmental sciences. The duration of the fellowship is two years. So far, twenty seven fellowship Awards have been given to various Scientists throughout the country.

### **B.P.Pal National Environment Fellowship for Biodiversity**

B.P.Pal National Environment Fellowship Award for bio-diversity was instituted during 1993 and is awarded annually with a view to further develop, deepen and strengthen the expertise on Bio-diversity available in the country.

The fellowship is in recognition of significant important research and development contributions and is also intended to encourage talented individual to devote themselves whole-time to R&D pursuits in the field of bio-diversity. Duration of the fellowship is two years. So far, ten Fellowship Awards have been awarded to various scientists throughout the country.

The reconstituted Advisory Committee meeting to consider the nominations received for the year 2007 and 2008 for Pitamber Pant National Environment Fellowship Award and Dr. B.P. Pal National Environment Fellowship Award for Biodiversity was held on 8<sup>th</sup> February, 2010 under the Chairmanship of Secretary (E&F) at Paryavaran Bhawan, New Delhi. Fellowships for the year 2009 and 2010 are under process.

### **E.K. Janaki Ammal National Award on Taxonomy**

The nominations for E.K. Janaki Ammal National Award on Taxonomy for the year 2008 were duly invited through advertisements in print and electronic media and by writing letters to all concerned. With the approval of Minister of State (IC), the

Ministry also extended the tenure of the Selection Committee from 08.09.2009 to 07.09.2012. A Meeting of the Selection Committee for the Janaki Ammal National Award on Taxonomy for 2008 is scheduled to be held on 23.03.2010 under the Chairmanship of Secretary (E&F). The Ministry has received twenty four nominations from various sources.

### **National Awards for Prevention of Pollution and Rajiv Gandhi Environment Award for Clean Technology**

The National Awards for Prevention of Pollution and the Rajiv Gandhi Environment Award for Clean Technology are given each year, in the following identified categories of highly polluting industries, of industries which have made a significant and measurable contribution towards development of use of clean technologies, products or practices that prevent pollution and find innovative solution to environmental problems:

#### **Large Scale Industries**

i) Sugar, ii) Fertilizer, iii) Cement, iv) Fermentation and Distillery, v) Aluminium, vi) Petro-chemicals, vii) Thermal Power, viii) Caustic Soda, ix) Oil Refineries, x) Sulphuric Acid, xi) Tanneries, xii) Copper Smelting, xiii) Zinc Smelting, xiv) Iron and Steel, xv) Pulp and Paper, xvi) Dye and Dye Intermediates, xvii) Pesticides, xviii) Pharmaceuticals.

#### **Small Scale Industries**

i) Tanneries, ii) Pulp and Paper, iii) Dye and Dye Intermediates, iv) Pesticides, v) Pharmaceuticals.

The National Awards for Prevention of Pollution are bestowed on twenty three industries (eighteen large scale and five small scale industries), one each for the above mentioned

categories of industries based upon their performance during the Award financial year.

The Rajiv Gandhi Environment Award for Clean Technology is given to the one which is the best among these industries, particularly from the angle of adoption of the clean technology. The Awards comprise a Cash Award of Rupees one lakh in addition to a silver Trophy and a Citation.

National Award for Prevention of Pollution for the year 2007-2008 under the Fertilizer category was awarded to M/s Indian Farmers Fertilizer Cooperative Ltd. (IFFCO), Aonla Unit, Bareilly, Uttar Pradesh for its commendable efforts towards conservation of energy and water, reduction in waste generation and for its commitment towards maintaining a safe, clean and healthy environment.

Nominations were invited for the National Awards for Prevention of Pollution and the Rajiv Gandhi Environment Award for Clean Technology for the year 2008-2009. Sixty seven nominations have been received for the Awards for the year 2008-2009 and evaluation of the same are being processed for consideration of the Award Committee.

### **Amrita Devi Bishnoi Wildlife Protection Award**



The "Amrita Devi Bishnoi Wildlife Protection Award" is a national award instituted by the Ministry for protecting wildlife, which carries a cash award of Rs. One lakh, apart from citation and medallion. This annual award is given to an individual/institution pertaining to rural communities for significant contribution in the field of wildlife protection, which is recognized as having shown exemplary courage and valor or having done some exemplary work for the protection of wildlife in the country.

### **Rajiv Gandhi Wildlife Conservation Award**

The Rajiv Gandhi Wildlife Conservation Award is given for significant contribution in the field of wildlife which is recognized as having made or has the potential to make measurable and major impact on the protection and conservation of wildlife in the country. Two awards of Rs. One lakh each, along with medallions, and citations, are given to:

- Education and research institutions and organizations, and
- Forests and Wildlife Officers/research scholars or scientists/ wildlife conservations.

In addition, the Ministry also awards two fellowships viz. a) Dr. Salim Ali National Wildlife Fellowship and b) Shri Kailash Sankhla National Wildlife Fellowship. The fellowships are awarded to inspire and promote, particularly the younger generation of wildlife managers and scientists, for taking up research/ experimental projects aimed at conservation of the rich wildlife heritage of this country. Dr. Salim Ali National Wildlife Fellowship and Shri Kailash Sankhla National Wildlife Fellowship Awards are awarded for Research/Experimental projects on avian wildlife and on mammalian wildlife respectively.

### **Medini Puraskar**

The Hon'ble Minister of State (Independent Charge) Environment & Forests, honoured four writers under Medini Puraskar Scheme with a view to encourage writing of original books in Hindi, on the subjects related to the environment for the year 2008.

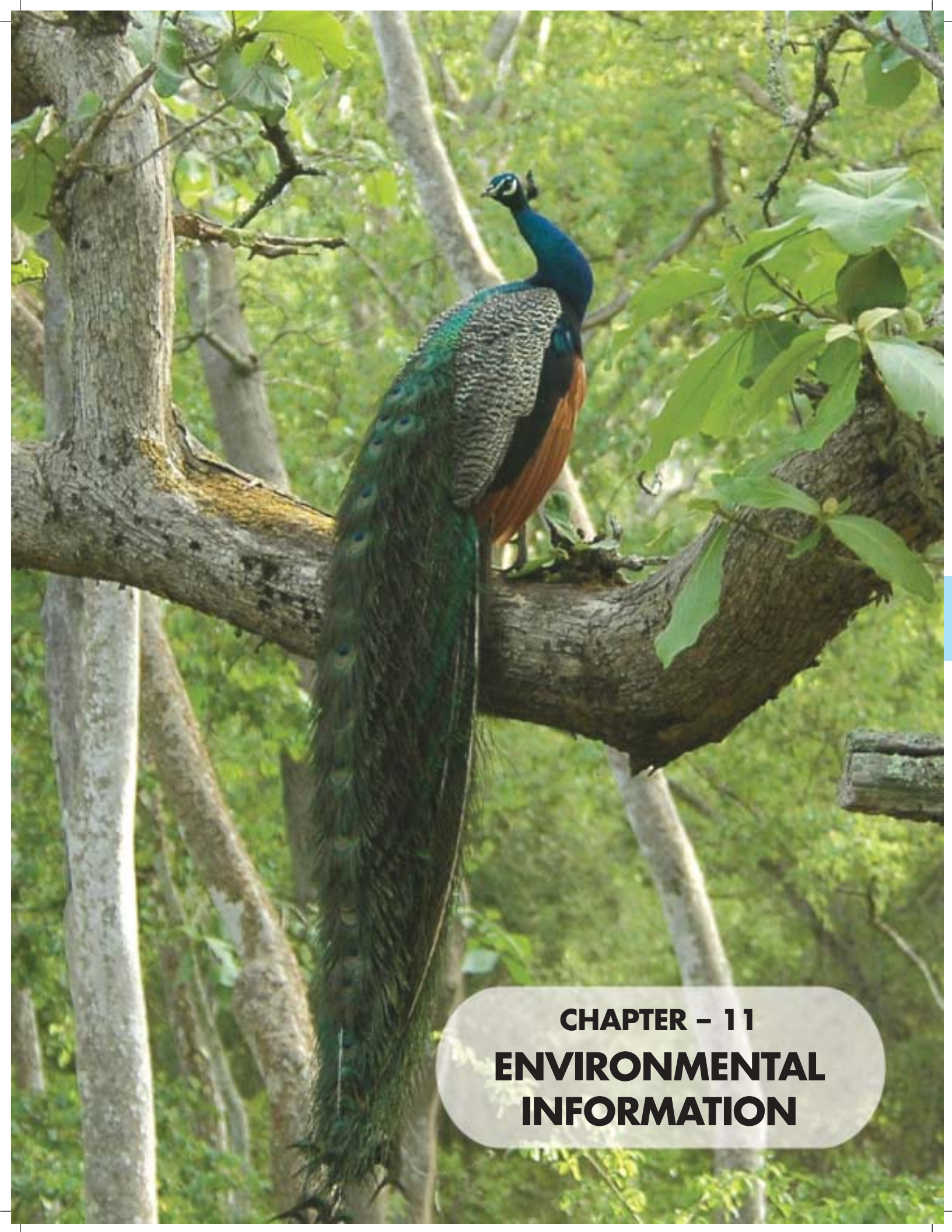

**CHAPTER - 11**  
**ENVIRONMENTAL**  
**INFORMATION**

## Environmental Information System (ENVIS)

### Introduction

All efforts towards protection and improvement of environment aim at sustaining good quality of life for living beings. Environmental management thus plays an important role in effecting a balance between the demands and resources available, thus keeping the environmental quality at a satisfactory level. In this regard, environmental information plays a very vital role not only in formulation of environmental management policies but also for decision-making process.

Realising the need of such information the Ministry set up an Environmental Information System (ENVIS) in 1983 as a plan programme and as a comprehensive network in environmental information collection, collation, storage, retrieval and dissemination to varying users, which include decision-makers, researchers, academicians, policy planners, research scientists, etc. ENVIS was conceived as a distributed information network with the subject-specific centres to carryout the mandates and to provide the relevant and timely information to all concerned. Association of the various State Governments/UTs was also felt necessary in promoting the ENVIS network to cover a wide range of disciplines of subjects and the cooperation of the various State/UT Governments. Keeping this in view, the network was expanded gradually with the involvement of thematic subject-areas and State Government departments to make it a

more comprehensive environmental information network.

ENVIS network at present consists of a chain of 76 network partners out of which 46 are on subject-specific and 30 are on State related issues. These network partners are called ENVIS Centres and are located in the notable organizations/ institutions/ Universities/State/UT Government Departments throughout the country. The Focal Point of ENVIS is located in the Ministry and coordinates the activities of all the ENVIS network partners to make ENVIS a web-enabled comprehensive information system. The list of ENVIS network partners is given at Annexure-X.

### Objectives

There are two objectives of Environmental Information System (ENVIS). One is "Long term" and the other is "Short-term" objectives.

#### Long Term Objectives

- To build up a repository and dissemination centre in Environmental Science and Engineering;
- To gear up the modern technologies of information acquisition, processing, storage, retrieval and dissemination of environmental nature;
- To support and promote research, development and innovation in environmental information technology.

#### Short Term Objectives

- To provide national environmental information service relevant to present



needs and capable of meeting the future needs of the users, originators, processors and disseminators of information.

- To build up storage, retrieval and dissemination capabilities, with the ultimate objective of disseminating information speedily to the users.
- To promote national and international cooperation and liaison for exchange of environment related information.
- To promote, support and assist education and personnel training programmes designed to enhance environmental information processing and utilizing capabilities.
- To promote and exchange of information amongst developing countries.

#### Progress of Activities carried out by ENVIS Network

The ENVIS network continued its information-related activities, database development, publication of requisite information packages through newsletters, abstracting services, etc. and also the query-response services during the year. Details of these activities are as follows:

- All the ENVIS Centres, both on the subject specific areas and status of environment and related issues established under the ENVIS Scheme, continued their information activities in their concerned specific areas. The activities of the ENVIS Network Partners are monitored and evaluated by various 'Expert Evaluation Committees' through Evaluation

Workshops. The workshops are held to evaluate the activities of the Centres to meet the objectives of ENVIS and necessary guidelines as well as mid-term corrections are provided to the Centres.

- A two-day National Seminar on the Coastal Ecosystems and Evaluation Workshop of South Indian State ENVIS Centres was held by the ENVIS Centre at the Kerala State Council for Science Technology and Environment (KSCSTE) during 2<sup>nd</sup>-3<sup>rd</sup> April, 2009 at Munnar, Kerala. The participating States presented the activities of their respective Centres before the Expert Committee and suggestions/guidelines were advised for further improvement.
- ENVIS Focal Point in the Ministry is responsible for maintenance and updation of the website of the Ministry (URL: <http://moef.gov.in>) and disseminating information through the website to all concerned. Information in the Ministry's website was continuously updated by ENVIS focal point throughout the year. The website (Fig.-45) has also been linked with the various Divisions of the Ministry in order to have up-to-date information on the subject concerned. Besides, the website is also regularly providing information on the new updates of the Ministry, response to media reports and other important issues of the Ministry from time to time with the objective of disseminating such information to all concerned. Information has also been arranged in various heads which include current events, clearances, legislation, Parliament matters, Treaties/Conventions,



## Ministry of Environment & Forests



Fig-45. Ministry's website (<http://moef.gov.in>)

Publications, etc. The website recorded a huge number of hits per month reflecting the usage of website by various national and international users. Ministry's website has been revamped with better look, content and design adopting latest technologies and keeping in view guidelines for development and management of government website to make it more transparent and user friendly.

- A portal of ENVIS at URL: <http://www.envis.nic.in> (Fig-46) connecting all the ENVIS network partners are updated regularly by the focal point. The portal acts

as a catalyst for inter-centre interaction and for information on several broad categories of subject related to environment under which the centres have been established. The websites of all the ENVIS network partners could be directly accessed from the homepage of the portal giving information on major events, activities and current updates of the entire network

- Query-Answer Service is one of the major responsibilities of ENVIS Network. The ENVIS focal point and all its partners responded a large number of queries during the year and provided substantive

information as far as possible. Wherever, information is not readily available, the network provided 'Referral Service' to the concerned users. The major subject-areas on which the queries were responded to pertain to climate change, ozone layer, environmental conservation, environmental standards, environmental education and awareness, water and air pollution, waste management and environmental laws etc.

- MOU for setting up new ENVIS Centres in Haryana and Lakshdeep has been received and actions are taken with the respective States/Union Territory Governments for signing on the Agreement and Terms of Contract for setting up ENVIS Centres. MoU from the Arunachal Pradesh and Meghalaya has been requested from respective State Governments for establishment of an ENVIS Centre in their states.

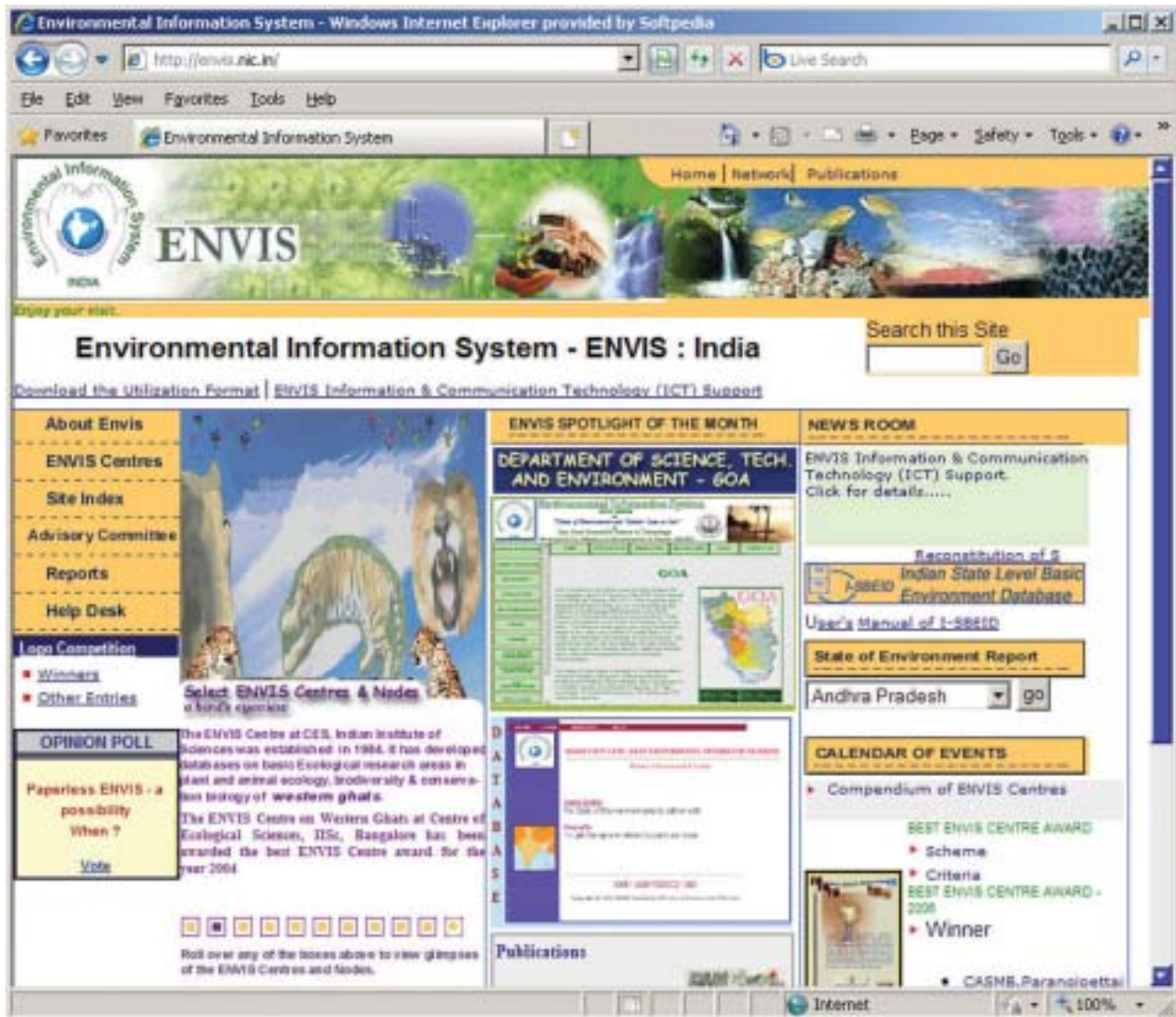

Fig-46. ENVIS website (<http://envis.nic.in>)

- The ENVIS Centre located at World Wide Fund for Nature – India published the 'Environment in Indian Parliament and Analysis – 2007' which was released by Hon'ble MoS (I/C) for Environment & Forests on the occasion World Environment Day, 2009.
- The Virtual Public Network (VPN) is being strengthened to assist the ENVIS network partners to upload the updated information at source. ENVIS focal point in the Ministry is monitoring the ENVIS Centres websites on regular basis apart from their overall activities.
- ENVIRONEWS, a quarterly newsletter, published by the focal point with the objectives of disseminating information on important policies, programmes, legislations and other important decisions taken by the Ministry from time to time to a wide cross-section of the society continued to be published. The abstracting journal 'Paryavaran Abstracts – reporting information on environmental research in Indian context' continued to be published.
- ENVIS focal point coordinated and published the Annual Report 2008-09 of the Ministry and got it distributed to various Central and State Government Departments, professional institutions, universities, research organizations, embassies/High Commissions of various countries in India, etc. and the concerned general public in order to disseminate the information package containing the activities of the Ministry during 2008-09. The electronic version of current and archived Annual Reports are also available on the website of the Ministry.
- During the year, the ISBEID programme of ENVIS was reviewed by the experts considering the inputs from the implementing States and NIC. Based on the review, actions have been initiated for extending the ISBEID programme for other remaining States/UTs with modified modules.
- The ENVIS has been representing the Ministry in various Committees of the Government, especially those constituted by Ministry of Programme Implementation and Statistics. It also provided necessary information for publication of Compendium of Environmental Statistics, report on Women and Men in India – 2008', Statistical Abstracts, etc., periodically.

### State of Environment Reporting Scheme

- During the year, Ministry published the 'State of Environment Report India, 2009' in collaboration with Development Alternatives, New Delhi. The SoER India, 2009 provides information in the forms of map, charts, data tables, photographs on various facets of green, blue and brown environmental issues and analyses following on the Pressure – State – Impact – Response (PSIR) analytical frame work. It outlines the state and trend of the environment (land, air, water, biodiversity) and five key environmental issues identified for India as (i) Climate Change, (ii) Food Security, (iii) Water Security, (iv) Energy Security and (v)

Managing Urbanization. The report was released by Shri Jairam Ramesh, Minister of State for Environment and Forests (I/C), on 11<sup>th</sup> August, 2009 in New Delhi.

- During the 10<sup>th</sup> Plan period, Ministry launched a scheme for preparation of State of Environment Report with the objective of highlighting the upstream and downstream linkages with environmental issues besides creating a baseline document in the form of SoE Report in which each State/UTs has to prepare the state of environment in their respective states. Under the scheme 100% central assistance was provided to the States/UTs to prepare their SoER. The scheme was extended to the 11<sup>th</sup> Five Year Plan and the Ministry continued the job for preparation of the State of Environment Report for those States/UTs left out in the previous Plan. The preparation of SoE Report for the states of Arunachal Pradesh, Karnataka, Uttar Pradesh, Tripura, Andhra Pradesh and the city of Hyderabad are in progress. Initiatives have been taken for preparation of SoE Report for the metro cities of Chennai and Delhi along with the state of Jammu and Kashmir.
- The Ministry had developed an "Interactive State of Environment Atlas" in collaboration with Development Alternatives, New Delhi. The Atlas provides information on all aspects of green (forests), blue (water) and brown (pollution) environmental issues in the forms of maps, data, tables, photographs and bibliographic materials

in an easy to use format so that it can be shared easily and quickly amongst the stake holders. The Interactive Atlas is being updated on a quarterly basis on the website.

### Statistical Cell

The role of Statistical Cell in the Ministry *inter alia* includes assistance to different Divisions of the Ministry in providing Statistical inputs and also to liaison with other Central Ministries/Organizations/ other agencies national and international in the matter of environment and forestry statistics. During the year the Cell provided inputs for various publications of Central Statistical Organizations on environment and forests. Statistical Adviser attended (i) 17<sup>th</sup> Conference of Central and States Statistical Organisations (COCSSO); ii) Expert Committee for Development of Database on Climate Change; iii) Committee on issues in the Estimation of GDP of Forestry Sector. Besides, some core statistics pertaining to the Ministry was identified and material sent to MoS & PI as recommended by National Statistical Commission.

### Information and Facilitation Centre (IFC)

The Information & Facilitation Counter at Paryavaran Bhavan has been functioning for over three years with the assistance of Centre for Environment Education, a Centre of Excellence supported under this Ministry. The IFC is equipped with a helpdesk, touchscreen computer and open display area to guide the visitors. The priced publications of the Ministry are available from the IFC against payment.



## Ministry of Environment & Forests

---

- IFC continued to disseminate the Ministry's publications such as Annual Reports, Brochures, Journals, Newsletters, Research Guidelines, Awards Guidelines, Funding Schemes etc. It is also providing guidance regarding application procedure for various schemes of the Ministry along with the information about the status of various applications submitted to the Ministry.
- IFC also helps in receiving the RTI applications from applicants under the "in-person" option.

### NGO Cell

- A Non-Governmental Organisation Cell (NGO Cell) has been set up in the Ministry

to handle various matters relating to NGO's working in diverse field of environment. The basic functions of the Cell are:

- Collection and dissemination of information to various NGOs.
- Liaison with the Planning Commission and other Government Ministries to create a database of various NGOs working in the field of environment and its associated areas.
- Attending Parliament Questions pertaining to NGO activities in the Ministry.
- Attending to RTI matters pertaining to information on NGO schemes in the Ministry.

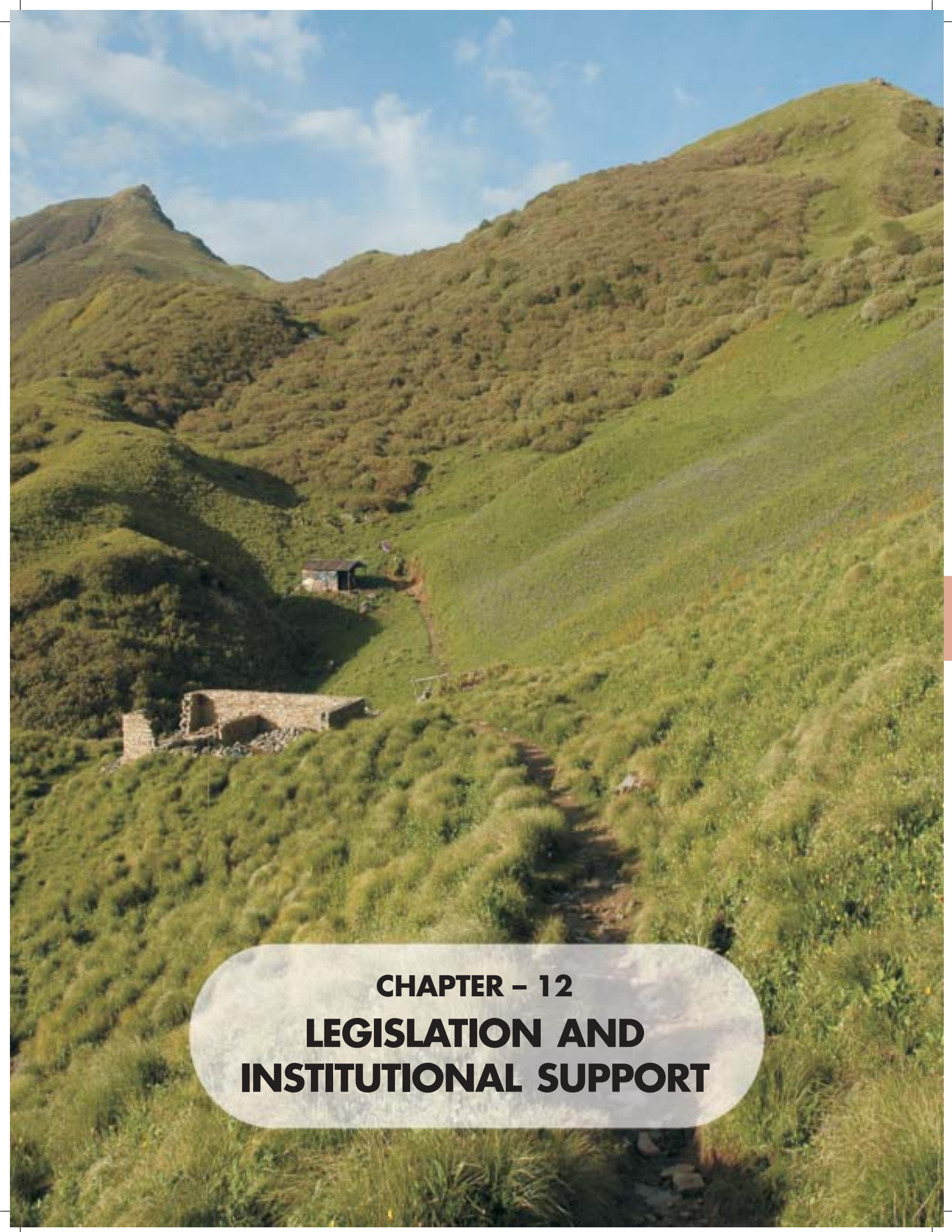

**CHAPTER – 12**  
**LEGISLATION AND**  
**INSTITUTIONAL SUPPORT**

### Introduction

The Policy and Law Division of the Ministry is partly implementing the schemes 'Assistance for Abatement of Pollution, Environment Policy and Law' and 'Establishment of Environment Commission and Tribunal' and providing legislative and institutional support to other thematic divisions whenever need for any amendment to existing legislation/notification or enactment of new legislation arises. In addition, the division is specifically looking after the implementation of the National Environment Policy 2006, National Green Tribunal Bill 2009, recommendations of the Law Commission in its 186<sup>th</sup> report and the Ecomark Scheme.

### The National Green Tribunal Bill, 2009

The National Green Tribunal (NGT) Bill, 2009 was introduced in the Lok Sabha on 31<sup>st</sup> July, 2009. The Bill provides for the establishment of a National Environment Tribunal for the effective and expeditious disposal of cases relating to environmental protection and conservation of forests and other natural resources including enforcement of any legal right relating to environment and giving relief and compensation for damages to persons and property.

The Bill was referred to the Department related Parliamentary Standing Committee on Science and Technology, Environment and Forests for examination and report. The Committee submitted its Report to the Rajya Sabha Secretariat on 24<sup>th</sup> November, 2009. The Cabinet in its meeting held on 3<sup>rd</sup> December, 2009 has approved the proposal regarding official amendments to NGT Bill 2009. Presently, the Bill is pending in the Lok Sabha for consideration and passing.

### National Environment Protection Authority

The Ministry has initiated a proposal to establish a National Environment Protection Authority (NEPA) to strengthen the regulatory framework and to improve the environmental governance in the country. A concept note on NEPA was uploaded in the Ministry's website and large numbers of suggestions have been received from various stakeholders. As part of the consultation process, a meeting was conducted on 26<sup>th</sup> November, 2009 in New Delhi in which representatives of State Governments, State Pollution Control Boards/ Pollution Control Committees, Central Pollution Control Board and line Ministries participated. A study has been awarded to IIT, Delhi to workout the scope and architecture of the NEPA in detail.

### National Environment Policy, 2006

The National Environment Policy (NEP) 2006 is the first comprehensive policy document formulated at national level for realizing the overarching goal of sustainable development in the country. It does not displace but builds on earlier policies. It is the outcome of extensive consultations with experts, governments, industry associations, academic and research institutions, civil society, NGOs and the public. The NEP outlines the significance of a number of new and continuing initiatives for enhancing environmental conservation which requires coordinated action of diverse actors and stakeholders at all levels.

– National Environment Policy has been widely circulated and is available on Ministry's website [www.moef.gov.in](http://www.moef.gov.in). The Division is coordinating the implementation



of the Action Plans of various divisions of Ministry of Environment and Forests. The concerned Central Ministries have been asked to formulate Action Plans for effective implementation of the NEP.

## Trade and Environment

### Introduction and objectives

With privatisation, liberalisation and globalisation of the Indian Economy, environment and forest sectors are also undergoing signs of change. Further with the looming dangers of global warming and climate change, environment has emerged as a matter of great concern both at the national as well as international level. Environment and forests sectors are increasingly figuring as areas of interests in the bilateral, plurilateral and multilateral Free Trade Agreements. India being a founder member of the World Trade Organisation (WTO) is governed by its basic binding principles and has been actively participating in such trade negotiations. The Doha Round of Trade Negotiations launched in November, 2001 has introduced negotiations in environmental goods & services. As a result, both the environmental goods and environmental services have emerged as areas of significance for India. Further the Para 31 (iii) of the Doha Ministerial Declaration (DMD) enjoins upon the WTO members to reduce or eliminate tariffs on environmental goods and services.

At the 7<sup>th</sup> Ministerial Conference of the WTO held in Geneva on 30<sup>th</sup> November to 2<sup>nd</sup> December, 2009, the Ministers reaffirmed the need to conclude the Doha Round in 2010 and for a stock-taking exercise to take place in the first quarter of next year.

There was support for asking Senior Officials to continue to work to map the road towards that point. Gaps however remained on substance and there was wide acknowledgment of the need for leadership and engagement on the remaining specific issues over the coming weeks.

Trade & Environment Cell of the Ministry undertakes following items of work:

- Provide technical inputs to the preparatory process in the area of trade & environment, in particular, items under negotiations in the WTO and other multilateral, bilateral and regional fora.
- Act as the nodal section within the Ministry to deal with references received from the Ministry of Commerce and Industry; and
- Implementation of the ongoing consultancy project on Trade & Environment.

### Activities undertaken during the year

During the year, the Trade & Environment Cell examined and furnished inputs from the Ministry of Environment and Forests (MoEF) to the Department of Commerce with regard to the negotiations under the aegis of the World Trade Organisation (WTO), both in the area of Environmental Goods and Services. The most important aspect of these negotiations being the list of one hundred fifty three environmental goods proposed by the demandeurs in the WTO for being adopted as the list for engaging in tariff reduction negotiations. Besides this list, a list of forty three climate friendly technologies/goods, proposed by the major proponents, is also under consideration in the WTO. However, the basic issues of modality and definition of environmental goods



## Ministry of Environment & Forests

---

remains unresolved. The Ministry of Environment & Forests, along with the Department of Commerce and the Centre for WTO Studies also participated in awareness raising consultations on Sanitary and Phyto-Sanitary Measures and Technical Barriers to Trade in four cities. During the year, the Ministry also participated in the Stakeholders'

Seminars on WTO negotiations organised by the Centre for WTO Studies under the Department of Commerce. Further, under the ongoing Project on Trade & Environment, being implemented with the Madras School of Economics, detailed papers on the various aspects of the issue are under preparation.

**CHAPTER – 13**  
**INTERNATIONAL COOPERATION AND**  
**SUSTAINABLE DEVELOPMENT**



### Introduction

The Ministry of Environment and Forests is the nodal Ministry in the Government of India for all Bilateral and Multilateral Environmental Agreements. These include Vienna Convention for the Protection of the Ozone Layer, Montreal Protocol on Substances that deplete the Ozone Layer, UN Conventions on Biological Diversity, UN Framework Convention on Climate Change, UN Convention to Combat Desertification, Kyoto Protocol, the Basel Convention on Transboundary Movement of Hazardous Substances, Stockholm Convention on Persistent Organic Pollutants, Rotterdam Convention, Ramsar Convention etc.



International Co-operation & Sustainable Development Division is the nodal point within the Ministry to coordinate all international environmental cooperation and sustainable development issues. It is the nodal Division for United Nations Environment Programme (UNEP), United Nations Development Programme (UNDP), World Bank, UNIDO, UN Commission for Sustainable Development (CSD), Global Environment Facility (GEF) and regional bodies like Economic & Social Commission for Asia & Pacific (ESCAP), South Asian Association for Regional Cooperation (SAARC), South Asia Cooperative Environment Programme (SACEP), ADB and European Union (EU), India Brazil South Africa (IBSA) Summit on Environment, India-Canada Environment Forum etc. The Division also handles bilateral country to country co-operation in the areas of environment protection and sustainable development.

### Progress/Achievements during the year

#### Commission on Sustainable Development (CSD)

- The United Nations Conference on Environment and Development (UNCED), was held in Brazil in 1992, adopted the Agenda 21, which is a blue print for a global plan of action for achieving sustainable development. The Commission on Sustainable Development (CSD) was set up in 1993 under United Nations Economic & Social Council (UN ECOSOC) for the purpose of review of progress of implementation of the Agenda 21. Ministry of External Affairs is the nodal Ministry for the CSD matters. However this Ministry plays the role for providing technical support and for implementation of the Agenda 21.
- The 17<sup>th</sup> Session (being the Policy Session) of the Commission on Sustainable Development (CSD), was held from 4-15 May, 2009 in New York, which considered the thematic areas of agriculture, rural development, land, drought, desertification and Africa. A delegation from India comprising the representatives from this Ministry and other line Ministries had attended the above Session under the leadership of the Minister of State in the Ministry of Environment and Forests.
- India had already submitted a National Report 'Sustaining Rural Lives and Livelihoods' to the Commission in its 16<sup>th</sup> Session.
- In order to strengthen the India's preparation towards the 17<sup>th</sup> Session of the Commission on Sustainable Development, a National Consultation was organized on 7<sup>th</sup> April,

2009 at Ahmedabad, Gujarat inviting the NGOs and Academic Institutions.

- The 17<sup>th</sup> Session, being a Policy Session, India has further brought out a handbook titled "Sustainable Development: The Indian Experience" showing the best practices prevalent in India relevant to the thematic areas of agriculture, rural development, land, drought and desertification. The proceedings of the 17<sup>th</sup> CSD are available at [http://www.un.org/esa/dsd/csd/csd\\_csd17.shtml](http://www.un.org/esa/dsd/csd/csd_csd17.shtml) .
- The CSD will organize its 18<sup>th</sup> Session as Review Session in New York, USA from 3-14 May, 2010. This session will focus on the different thematic issues such as (i) Transport (ii) Chemicals (iii) Waste Management (Hazardous and Solid waste) (iv) Mining and (v) A 10 year Framework of Programmes on Sustainable Consumption and Production
- The CSD is organizing the Regional Implementation Meetings (RIMs) region-wise in order to contribute to the work of CSD 18 and to identify region-specific obstacles and constraints, new challenges and opportunities, and sharing of lessons learned and best practices concerning to the thematic issues of CSD 18. The Regional Implementation Meeting for Asia and the Pacific was held in Bangkok, Thailand from 30 November, 2009 to 1<sup>st</sup> December, 2009 which was participated by the representative of this Ministry,

### **United Nations Environment Programme (UNEP)**

- The United Nations Environment Programme (UNEP) established in 1972 after the Rio Earth Summit is the principle entity within

the UN System to assist the developing countries in building scientific and technical capacity, fostering partnership and knowledge development to promote environment for sustainable development. Based in Nairobi, Kenya, UNEP activities are range from assessment of environmental trends, especially early warning systems to dealing with the environmental disasters and emergencies to the promotion of environmental science and information.

- One of the main responsibilities of the UNEP is to keep under review the world environmental situation and ensure that emerging environmental problems of wide international significance are prioritized and receive appropriate and adequate consideration by the Governments.
- The Governing Council/Global Ministerial Environment Forum of UNEP is the high level environment policy forum which brings the world's environment ministers together to "review important and emerging policy issues in the field of the environment". The Council/Forum meets annually,
- The UNEP Council/Forum is organizing its 11<sup>th</sup> Special Session at Bali, Indonesia from 24-26 February, 2010. The theme of the meeting is 'Environment in the multilateral system' under which various issues of international environment governance, green economy, biodiversity and ecosystem services, international law etc. will be discussed.

### **Global Environment Facility (GEF)**

- The Global Environment Facility (GEF) established in 1991, as an independent financial mechanism provides grants to developing countries and economies in

transition for projects that benefit the global environment and promote sustainable livelihoods. India is a founder member of GEF. We are both a donor and recipient of GEF funds. India represents GEF South Asia Constituency (including Bangladesh, Bhutan, Maldives, Nepal and Sri Lanka) in GEF Council.

- GEF projects address six focal areas – biodiversity, climate change, land degradation, international waters, ozone layer depletion and persistent organic pollutants. They also address two crosscutting issues viz., sustainable forest management and sound chemical management. The GEF is a project co-financer providing “new and additional” funds to address the global environmental issues. GEF projects are implemented through its 10 agencies including UNDP, WB, UNEP, UNIDO, FAO, IFAD, ADB, AfDB, EBRD and IDB.
- Over the past 18 years, the GEF has invested USD 8.6 billion directly as grant and leveraged USD 36.1 billion in co-financing for more than 2,400 projects in more than 165 countries. Since 1991, India has contributed about USD 42 million to GEF, accessed about USD 331 million as GEF grant while leveraging a co-financing of USD 1,989 million.
- The Ministry of Environment and Forests (MoEF), Govt. of India is the designated GEF Operational Focal Point India. It is primarily responsible for the in-country coordination of GEF projects and other operational activities as well as participating in the GEF Council meetings at Washington twice a year. The Department of Economic Affairs is the GEF Political Focal Point India

responsible for GEF governance and policy related issues.

- The GEF Empowered Committee chaired by the Secretary (E&F) functions as an empowered body to determine national priorities, streamline eligibility checks, approvals and endorsements of GEF proposals, monitor project implementation, and in formulating country’s stand for the meetings of GEF Assembly and Council. The Committee meets on a quarterly basis. The GEF Cell in the Ministry assists in coordinating GEF activities in the country. The projects/ concept notes can be submitted to the GEF Cell on a rolling basis.

### Small Grant Programme (SGP)

- Launched in 1992, GEF Small Grants Program (SGP) complements GEF full- and medium-sized project funding, by providing a window for the direct participation of NGOs, local communities, and other grassroots organizations. SGP is a country wide, focus on the tribal, remote, inaccessible areas and with Indigenous tribal people. SGP India has funded more than 300 projects worth USD 5.2 million of grant and co-finance leveraged is USD 6.2 million from communities and other stakeholders like Govt., local administration & private sector
- On behalf of this Ministry, the SGP in India is being hosted and coordinated by the Centre for Environment Education. The National Steering Committee chaired by the Joint Secretary, IC & SD Division, which approves the projects on a quarterly basis. The project proposals/ concept notes could be submitted to the CEE’s regional cells on a rolling basis.

- SGP is a flagship program. To upscale and replicate successful SGP India initiatives at the grassroots level, the Ministry has provided a grant of Rs 1.7 crore (since 2005 – 06).

### South Asia Cooperative Environment Programme (SACEP)

- SACEP was set up in 1982 with headquarters in Colombo, Sri Lanka. It aims to promote regional Co-operation in South Asia in the field of environment, both natural and human, in the context of sustainable development and on issues of economic and social development which also impinge on the environment and vice versa. It supports conservation and management of natural resources of the region by working closely with all national, regional, and international institutions, governmental and nongovernmental efforts, as well as experts and groups engaged in such co-operation and conservation.
- Secretary, Ministry of Environment and Forests is the SACEP Focal Point for India. The SACEP holds its Governing Council (GC) meetings, which concentrate on current regional issues as well as global concerns. The 11<sup>th</sup> Governing Council of SACEP was held at Jaipur, India from 20-22 May, 2008. The meeting deliberated upon organizational, institutional and programmatic matters relating to environmental cooperation in South Asia Region.

### Delhi Sustainable Development Summit, 2009

- Sustainable Development being a thrust area of the Ministry of Environment and Forests, this Ministry has been supporting The Energy

and Resources Institute (TERI) has been organizing Delhi Sustainable Development Summit (DSDS) since 2001.

- The 9<sup>th</sup> Delhi Sustainable Development Summit was organized by TERI from 5-7 February, 2009. The theme of the summit was 'Toward Copenhagen: An Equitable and Ethical Approach'.
- The 10<sup>th</sup> Delhi Sustainable Development Summit will be organized by TERI from 5-7 February, 2010 which will focus on the theme 'Beyond Copenhagen: New Pathways to Sustainable Development'.

### South Asian Association for Regional Cooperation (SAARC)

- The South Asian Association for Regional Cooperation (SAARC), which is an intergovernmental body, was established in 1985 with the aim to provide a platform for the peoples of South Asia to work together in a spirit of friendship, trust and understanding so that the process of economic and social development in Member States could be accelerated. The SAARC has eight countries as its members, viz., Afghanistan, Bangladesh, Bhutan, India, Maldives, Nepal, Pakistan, Sri Lanka.
- So far, eight Environment Ministers Conferences have been held under SAARC, which also has a Committee on Environment, Meteorology and Forest, for working out the detailed plan of action in these areas and implementing the same. Strengthening regional cooperation in environment is the focus of the SAARC meetings.
- At the request of the SAARC Secretariat to the Government of India to host the 8<sup>th</sup> Meeting of the SAARC Environment

Ministers, this Ministry hosted the 8<sup>th</sup> Meeting of the SAARC Environment Ministers on 20<sup>th</sup> October, 2009 preceded by the meeting of the Senior Officials of the SAARC Countries on 19<sup>th</sup> October, 2009, at New Delhi in collaboration with the Ministry of External Affairs.

- Shri Jairam Ramesh, Minister of State (independent Charge), Environment and Forests had chaired the 8<sup>th</sup> Meeting of the SAARC Environment Ministers and Shri Vijai Sharma, Secretary, Ministry of Environment and Forests had chaired the meeting of Senior Officials of SAARC Countries. Both the meetings were attended by the Environment Ministers and Senior and Associated Officers of the SAARC countries viz Afghanistan, Bangladesh, Bhutan, Maldives, Nepal, Pakistan and Sri Lanka, officials from SAARC Secretariat, UNEP Regional Office, SAARC Meteorological Research Centre, Dhaka and SAARC Disaster Management Centre, New Delhi. Senior Officers from the Ministry of Environment and Forests, Ministry of External Affairs, Ministry of Home Affairs, Department of Science and Technology and Indian Meteorological Department also attended the meetings. .
- H.R.H. Prince Mostapha Zaher, Director General, National Environmental Protection Agency of Afghanistan, H.E. Dr. Hasan Mahmud, State Minister, Ministry of Environment and Forests of Bangladesh, H.E. Dasho Nado Rinchen, Deputy Minister, National Environment Commission of Bhutan, Mr. Vijai Sharma, Secretary, Ministry of Environment and Forests of India, H.E. Mr. Mohamed Aslam, Minister of Housing, Transport and Environment of the Maldives,

H.E. Mr. Thakur Sharma, Minister for Environment of Nepal, Mr. Kamran Lashari, Secretary, Ministry of Environment of Pakistan and Hon. Mr. Patali Champika Ranawaka, MP, Minister of Environment and Natural Resources of Sri Lanka, made their respective country statements in the meetings.

- The outcome/salient features of the meetings are as follow:
  - (i) The Meeting noted that cooperation in a number of areas pursuant to the directives issued by the Fourteenth and Fifteenth SAARC Summits have been identified in the draft "SAARC Treaty on Cooperation in the field of Environment". The Meeting resolved to pursue meaningful cooperation in the identified areas after the draft Treaty has been finalized by the Inter-governmental Expert Group and formally signed during the Sixteenth SAARC Summit
  - (ii) The Meeting agreed to present a common position at the forthcoming COP 15 Conference in Copenhagen in December 2009 and also decided to consider organizing an appropriate SAARC side event on the sidelines of COP 15, the modalities of which will be decided in due course. The meeting directed the SAARC Secretariat to circulate a draft common position based on the SAARC position presented at the Bali Conference in 2007 and the relevant sections on Climate Change as contained in the Delhi Statement on Cooperation in Environment to Member States. It was agreed that Sri Lanka as the current Chair of SAARC would present the



common SAARC position at COP 15. The offer by the Government of India to discuss and finalize the logistical arrangements for the SAARC side event with the organizers in Copenhagen and the UNFCCC Secretariat was welcomed.

- (iii) The meeting agreed to publish a compendium of SAARC National Plans of Action on Climate Change before the forthcoming COP 15 Conference in Copenhagen in December 2009. Member States were requested to submit copies of their respective National Action Plans to the SAARC Secretariat soon.
- (iv) The meeting noted the proposal by Bangladesh for expanding the mandate of and strengthening the SAARC Meteorological Research Center (SMRC), Dhaka, to deal with Climate Change issues and also requested the Government of Bangladesh to submit a Concept Paper by February 2010 for the consideration of Member States.
- (v) The meeting welcomed the proposal by Bhutan to adopt Climate Change as the theme for the Sixteenth SAARC Summit and took note of the Concept Paper circulated by Bhutan.
- (vi) The Meeting expressed its appreciation for the excellent work done by the Senior Officials and approved the recommendations contained therein.
- (vii) The Meeting approved and adopted the SAARC Ministerial Statement on

Cooperation in Environment ("Delhi Statement").

- (viii) The meeting approved the recommendations of the Senior Officials Meeting and agreed that Member States that have yet to forward copies of their National Plans of Action to the Secretariat for the implementation of the Comprehensive Framework on Disaster Management and Disaster Prevention would do so at an early date. The Meeting also appreciated the offer of Bangladesh to host an Expert Group Meeting after all Member States have submitted their respective National Plans of Action. The dates for the Expert Group Meeting will be communicated to the Member States through the SAARC Secretariat.
- (ix) The Meeting endorsed the recommendation by the Senior Officials to utilize the expertise of SAARC Disaster Management Centre (SDMC), New Delhi to harmonize the National Reports and articulate a Regional Plan of Action.
- (x) The meeting also appreciated the draft "SAARC Treaty on Cooperation in the field of Environment" prepared by the Government of India, and endorsed the recommendation to convene an Inter-governmental Expert Group (IGEG) Meeting to discuss and finalize the draft Treaty, so as to enable its formal adoption during the Sixteenth SAARC Summit scheduled to take place in Thimpu, Bhutan in April 2010.

– This Ministry is organizing the following two meetings of Senior Officers from the SAARC countries in New Delhi from 18-19 January, 2010 respectively:

- (i) Inter-Governmental Expert Group (IGEG) meeting on SAARC Treaty on Cooperation in the field of Environment.
- (ii) Expert Group (EGM) meeting to finalize the concept papers

### Bilateral Cooperation

– Meeting of Joint Working Group on Environment have been held with Norway, Finland and European Union.

- (i) 3<sup>rd</sup> Meeting of Indo-Norwegian Joint Working Group was held from June 29-1<sup>st</sup> July, 2009 in Oslo. In this meeting exchange of views on international conventions like UNFCCC, UNCBD and UNEP was held. In addition issues pertaining to Eco-village, Eco-Business Partnership, Incineration of hazardous waste were discussed.

- (ii) IBSA Environment Working Group Meeting was held in Rio de Janeiro, Brazil during July 14-17, 2009 which was attended by Shri B.S. Parsheera, Special Secretary, MoEF and Shri Jagdish Kishwan, D.G., ICFRE, Dehradun. The matters discussed in this meeting were Climate Change, Biodiversity and Forests.

- (iii) The 5<sup>th</sup> Meeting of Joint Working Group on Environment with Finland was held in New Delhi on 01.09.2009. In this meeting Mythologies to control Air Pollution, Business perspective to environmental

cooperation, Waste Management, Climate Change etc. were discussed.

- (iv) The 6<sup>th</sup> Meeting of meeting EU-India Joint Working Group was held in Brussels, Belgium on 4<sup>th</sup> December, 2009 in which deliberated on issues of Ship Dismantling, Water Management, Environmental Impact Assessment and Electronic Waste.

- (v) The project proposals discussed in the above meetings are being implemented in consultation with Department of Economic Affairs.

- (vi) Apart from the above following bilateral agreements have also been signed during the year 2009-10.

– An MoU between the Government of Denmark and the Government of India for cooperation in the field of environment has been signed on 11.09.2009. The areas to be covered for cooperation are Water and Air Pollution Control, Waste Management, Harmful Chemical Management and Clean Technologies etc.

– An MoU between the Government of Sweden and Government of the Republic of India for cooperation in the field of Environment has been signed on 5th November, 2009. The area to be covered are environmental governance in the areas of environmental legislation, regulation, monitoring, enforcement and planning.

– Both the MoUs have opened up new areas of cooperation between the two countries by providing institutional platform for effective coordination of common perspectives in international fora and also for joint efforts for achievements of common goals in the field of environment.

## World Bank

- IC&SD Division is nodal division for the overall World Bank portfolio in environmental projects. It coordinates the initial tying up of activities including crucial negotiations before the projects are actually started by the concerned thematic divisions.
- Ms. Katherine Sierra, Vice President for Sustainable Development Network, World Bank along with her team met with Secretary (Environment & Forests) on 4<sup>th</sup> February, 2009 to discuss the role of World Bank in supporting climate change and sustainable development in India and globally.

## 3rd India Roundtable on Sustainable Consumption and Production (SCP)

- The unsustainable production and consumption pattern constitutes a great environmental problem towards sustainable development as recognized in the World Summit on Sustainable Development held in Johannesburg, South Africa during 2002.
- Ministry of Environment & Forests alongwith the United Nations Environment Programme (UNEP) is organizing the 3rd India Roundtable on SCP in New Delhi in February, 2010.

## Externally Aided Projects (EAPs)

The Externally-Aided Projects Division deals with the appraisal, approvals and monitoring of forestry-related projects which are funded by external agencies. These projects are implemented in the States with assistance from external funding agencies viz. Japan International Cooperation Agency (JICA), World Bank (WB), etc. At present, nine projects are assisted by JICA and one by the World Bank.

The funds are utilized for promoting afforestation, regeneration of degraded forest areas, water and soil conservation measures, farm forestry, agro forestry with the aim to increase forest and tree cover as well as to augment availability of fuel wood and fodder, improve the livelihood opportunities and quality of life of the villagers adjoining forests, strengthening joint forest management institutions to ensure people's participation, besides encouraging tree growing on private land as well as greening of the urban areas in accordance to the objectives envisaged in various projects under implementation. These projects are reimbursed their actual expenditure as per the loan agreements.

At present, ten State Sector Forestry Projects with an investment of about Rs. 5,287 Crores are being implemented in ten States and another project under Central Sector titled "Capacity Building for Frontline Staff in Forestry Sector" with an outlay of Rs. 225 crores is being implemented in 10 States. Details of projects under implementation, their objectives, components, project cost, project period, etc. are given in Table-29.

The following forestry projects have been included for consideration under the *Rolling Plan for 2009-11* for external funding:

*Under consideration by JICA:*

- Integrated Project for Sustainable Development of Forest Resource in Sikkim.
- Tamil Nadu Natural Resource Management Project

*Under consideration by AFD (French Development Agency):*

- Assam Forestry Development Project

## Ministry of Environment & Forests

**Table-29.** Details of ongoing projects under financial assistance from various funding agencies

S. No	Name of the Project	Implementing Agency/ State	Cost (in Rs. Crores)	Funding Agency	Objectives	components	Project Period
1.	Uttar Pradesh Participatory Forest Management and Poverty Alleviation Project	Uttar Pradesh	575	JICA	To restore degraded forests, to augment forest resources and to improve livelihood for and empower the local people who are depend on forests by promoting sustainable forests management including JFM plantation and community development, thereby improving environment and alleviating poverty.	<ul style="list-style-type: none"> <li>i. Plantations, regeneration of forests, etc.</li> <li>ii. Institutional Strengthening of PMU/DMUs/FMUs</li> <li>iii. Rehabilitation of Forest Training Institute at Lucknow.</li> <li>iv. Communication and Publication.</li> <li>v. Monitoring and Evaluation.</li> <li>vi. Physical Contingency</li> <li>vii. Consulting Services</li> </ul>	2008-09 To 2015-16
2.	Gujarat Forestry Development Project – Phase II	Gujarat	830	JICA	Ecological conservation and restoration; Conservation flora, fauna and natural heritage.; Increase tree cover in and outside the forests; Enhancing people's participation; Socio-economic empowerment of local people; Increase productivity of augment supplies; Research and development; Organizational capacity building.	<ul style="list-style-type: none"> <li>i. Preparatory works</li> <li>ii. Departmental Forest Development and Management</li> <li>iii. JFM Forest Development and Management</li> <li>iv. Social Forestry Development and Management</li> <li>v. Forest Research</li> <li>vi. Communication and Publication</li> <li>vii. Wildlife Conservation and Management</li> <li>viii. Monitoring and Evaluation</li> <li>ix. Phase-out works</li> <li>x. Consulting Services (including price and physical cont.)</li> </ul>	2007-08 To 2015-16
3.	Tripura Forest Environmental and Poverty Alleviation Project	Tripura	366	JICA	To restore degraded forests and improve the livelihoods aspects of villagers, including tribal families engaged in traditional shifting cultivation, and promoting sustainable forest management through JFM, thereby improving environment and alleviating poverty.	<ul style="list-style-type: none"> <li>i. Rehabilitation of degraded land.</li> <li>ii. Rehabilitation of degraded and available non forest land.</li> <li>iii. Farm forestry in Private holding.</li> <li>iv. Eco-Development.</li> <li>v. Service Support.</li> <li>vi. Rehabilitation of families engaged in shifting cultivation.</li> <li>vii. Interface forestry Development.</li> <li>viii. Supporting Works</li> </ul>	2007-08 To 2014-15

## Annual Report 2009-2010

4.	Swan River Integrated Watershed Management Project	Himachal Pradesh	162	JICA	To regenerate the forests, protect the agricultural land, and enhance agricultural and forestry production in the catchment area of the Swan River, Himachal Pradesh State, by carrying out the integrated watershed management activities including afforestation, civil works for soil and river management, soil protection and land reclamation, and livelihood improvement activities, thereby improving living conditions of people including the poor in the catchment area.	<ul style="list-style-type: none"> <li>i. Afforestation</li> <li>ii. Civil Work for Soil &amp; River Management</li> <li>iii. Soil Protection &amp; Land Reclamation</li> <li>iv. Livelihood Improvement</li> <li>v. Institutional Development</li> </ul>	2006-07 To 2013-14
5.	Orissa Forestry Sector Development Project	Orissa	660	JICA	To restore degraded forests and improve the income level of villagers by promoting sustainable forest management including JFM plantation and Community/tribal development, thereby improving environment and alleviating poverty.	<ul style="list-style-type: none"> <li>i. Protection and Conservation of Biodiversity of forests</li> <li>ii. Improving productivity of natural forests.</li> <li>iii. Providing livelihood options for the people (Support to VSS)</li> <li>iv. Eco-development and ecotourism activities</li> <li>v. Catering to commercial and industrial demands</li> <li>vi. Capacity building of the Forest Department.</li> </ul>	2006-07 To 2012-13
6.	Karnataka Sustainable Forests Management & Bio-diversity Conservation	Karnataka	745	JICA	To restore forest to bring about ecological restoration and also to facilitate livelihood improvement of the inhabitants of the project villages by afforestation through Joint Forest Planning and Management (JFPM) in the State of Karnataka, which further contributes to reducing poverty and preserving biodiversity conservation of the area?	<ul style="list-style-type: none"> <li>i. Afforestation</li> <li>ii. Income Generation Activities for Poverty Alleviation</li> <li>iii. Biodiversity Conservation</li> <li>iv. Provision of Basic Infrastructure Support for Field work.</li> <li>v. Supporting Activities for Forest management (Research and Training, Consultancy, and Enhancement of Geographic Information System (GIS) and Management Information System (MIS)</li> </ul>	2005-06 to 2012-13
7.	Tamil Nadu Afforestation project phase-II	Tamil Nadu	567	JICA	To restore forests to bring about ecological restoration and also to facilitate livelihood improvement of the inhabitants of the project villages by afforestation through Joint Forest Management in the State of Tamil Nadu, which further contributes to reducing poverty in the area.	<ul style="list-style-type: none"> <li>i. Integrated Watershed Development</li> <li>ii. Integrated Tribal Development</li> <li>iii. Forestry Extension</li> <li>iv. Urban Forestry</li> <li>v. Capacity Building</li> <li>vi. Research Support</li> <li>vii. Human Resources Development</li> <li>viii. Establishment of Modern Nurseries</li> <li>ix. Improving the infrastructural facilities</li> <li>x. Administration</li> <li>xi. Monitoring and Evaluation</li> </ul>	2005-06 to 2012-13

## Ministry of Environment & Forests

8.	Integrated Natural Resources Management and Poverty Reduction Project in Haryana	Haryana	286.01	JICA	A. To rehabilitate forest lands in an ecologically sustainable manner. B. To improve the quality of life of the villagers and adjoining forests.	i. Soil and Water Conservation ii. Plantation model and nursery development iii. Poverty reduction and institution building iv. Technical assistance v. Supporting activities vi. Administration Staff.	2004-05 to 2010-11
9.	Rajasthan Forestry and Biodiversity Project	Rajasthan	442	JICA	To carry out plantation works, soil and moisture conservation works to check the desertification and improve the ecological status of the Aravalis; to protect the infrastructures like canals, roads; to improve biodiversity; to augment the availability of forest products like fuel wood, fodder; to generate employment opportunities; and to improve the socio-economic conditions of the rural poor through active participation by local communities.	i. Plantation ii. Joint Forest Management Consolidation Activities iii. Biodiversity Conservation iv. Equipment and Monitoring Facilities etc. v. Research, Extension and Training Activities	2003-04 to 2007-08 (extended upto 31 <sup>st</sup> July, 2010)
10	Andhra Pradesh Community Forests Management Project	Andhra Pradesh	653.97	World Bank	Promote sustainable natural resource management with focus on policy and institutional reforms to sustain and improve the livelihoods of the rural poor.	i. Livelihood Promotion ii. Forest Management iii. Institutional Strengthening iv. Project Management Support, etc.	2002-03 to Sept. 2009 (extended upto 31-3-2010)
11.	Capacity Development for Forest Management and Training of Personnel	DFE, Dehradun and 10 States (Assam, Bihar, Chhattisgarh, Jharkhand, Kerala, Madhya Pradesh, Maharashtra, Sikkim, Uttarakhand and West Bengal)	225	JICA	To improve training environment for frontline staff through the rehabilitation of States Forests Training Institutes and through capacity building of frontline forestry staff putting emphasis on Joint Forests Management (JFM), thereby strengthening human resource development for sustainable forest management.	i. To improve training environment for frontline staff through the rehabilitation of States ii. Forests Training Institutes and through capacity building of frontline forestry staff putting emphasis on Joint Forests Management (JFM), thereby strengthening human resource iii. Development for sustainable forest management.	2008-09 to 2013-14 (5 years and 3 months)
<b>Total</b>			<b>5512</b>				

The following forestry projects are under consideration for inclusion in *Rolling Plan for 2010-12*:

– West Bengal Forestry Project

– Rajasthan Forestry and Bio-diversity Project Phase-II

– Maharashtra Natural Resources Management Project

- Integrated Forest Resources Management in Jammu & Kashmir

EAP Division also acts as a nodal point being the *North-East Cell* in respect of North Eastern States for forestry related matters and following activities:

- Forest based industrial estates,
- Transportation of forest produce,
- Court cases in apex court, etc.

## Climate Change

### Introduction

Climate Change is a serious global environmental concern, which is primarily caused by the building up of Greenhouse Gases in the atmosphere. Recent discourse on climate change has underscored the fact that climate change occupies a high priority on the environmental agenda of international community.

India, as a party to the United Nations Framework Convention on Climate Change, 1992 and its Kyoto Protocol, 1997 has been committed to address the global problem on the basis of the principle of “common but differentiated responsibilities and respective capabilities” of the member Parties. The objective of UNFCCC is to stabilize the concentration of greenhouse gases in the atmosphere at a level that prevents dangerous anthropogenic interference with the climate system. The Kyoto Protocol adopted in 1997 by the parties to UNFCCC sets legally binding targets for GHG reductions by industrialized countries during the “first commitment period”, 2008-2012.

The Kyoto Protocol expects the developed country Parties to reduce, by

2012, their GHG emissions by an order of 5.2% below their aggregate 1990 emissions. It makes provisions for use of any of the three mechanisms including the Clean Development Mechanism (CDM) to help developed countries meet their quantified emission limitation and reduction commitments domestically and through acquisition of greenhouse gas reduction credits from activities outside their own boundaries at relatively lesser costs. India is a major participant in the projects aimed at using Clean Development Mechanism.

The Fourth Assessment Report of *Intergovernmental Panel on Climate Change* 2007 has brought climate change issue to the fore and has led the parties to make serious efforts to address the problem through long term cooperative actions as agreed under the Bali Action Plan. The IPCC has made serious projections of the future scenario in terms of global warming and predicted that there may be adverse impact of climate change on agriculture, water resources, eco-systems, sea levels, human health and result in rise in extreme weather events.

### Impact of Climate Change on India

India has always been subject to a large degree of climate variability. This is likely to be accentuated by climate change. According to IPCC, the global temperature may rise by 2-4.5°C by the end of this century, including a 2.7-4.3°C increase over India by the 2080s if adequate actions are not taken to reduce emissions globally. At the national level, the observed increase in surface air temperatures over the past century is 0.4° C. A warming trend along the west coast, in central India, the interior peninsula, and north-eastern India and cooling trends in north-west

India and parts of south India have been observed. Coasts are projected to be exposed to increase in risk including coastal erosion due to climate change and sea level rise. Geological Survey of India projects that the glaciers of Himalaya are receding at varying rates in different regions.

India is conscious of these challenges and has implemented several major programmes addressing the climate variability concerns. These include cyclone warning and protection, coastal protection, floods and drought control and relief, major and minor irrigation projects, control of malaria, food security measures, research on drought resistant crops, etc. India spends almost 2.5% of its GDP on such programmes.

### India's emissions and climate change

With 17 per cent of the world's population, India contributes only 4 per cent of the total global greenhouse gas emissions. In terms of per capita GHG emissions, it is about 23 per cent of the global average. Its per capita consumption of energy is 530 kgoe of primary energy compared to the world average of 1770 kgoe and its per capita emission of CO<sub>2</sub> is among the lowest in the world. India's CO<sub>2</sub> emissions are approximately 1 tonne per annum as against a world average of 4.2 tonnes per annum, while the average for industrialized countries ranges between 10-20 tonnes per capita. This is significant in the background of declining energy intensity of GDP of India; this is a result of policies, regulations and programmes set up over the years to address energy efficiency and energy security concerns. This has had a positive effect on India's development process.

India is one of the few developing countries in the world where the forest cover is increasing, despite the pressure of population growth and rapid economic development. As a result of the policies, deforestation has almost completely stopped, and afforestation is adding forest cover to about 0.25% of India's land area every year. More than a fifth of India's land area is under forest cover and this serves as a major carbon sink, with almost 11% of India's annual emissions being absorbed by the forests. The cover is increasing every year @ almost 0.8 mn hectares every year (proposed to be raised to 2.3 mn hectares p.a. through the new afforestation initiatives).

Amongst 70 countries studied by the World Bank recently, India ranked 48<sup>th</sup> in 2004 in terms of CO<sub>2</sub> emissions per unit of GDP. India's emissions per capita ranked 63<sup>rd</sup>, i.e., among the lowest in the world. Moreover, India's offsetting factor was found to be in line with global economy. According to the study, during the period 1994-2004, India offset 30% of the growth in emissions attributable to increased GDP and population, through improvements in energy intensity, fossil fuel mix, and fossil fuel share in total energy consumption where as some other large countries saw a poorer offsetting performance in the sub-period 1999-2004.

### National Action Plan on Climate Change

As a part of voluntary actions to address climate change related concerns, India launched its National Action Plan on Climate Change (NAPCC) on 30<sup>th</sup> June 2008. The National Action Plan stresses that maintaining a high growth rate is essential for increasing living standards of the vast majority of people



of India and reducing their vulnerability of the impacts of climate change. The Action Plan outlines a national strategy that aims at enabling the country adapt to climate change and enhances the ecological sustainability of India's development path.

Eight National Missions (National Solar Mission, National Mission on Enhanced Energy Efficiency, National Mission on Sustainable Habitat, National Water Mission, National Mission for sustaining the Himalayan Ecosystem, National Mission for a Green India, National Mission for Sustainable Agriculture and National Mission on Strategic Knowledge for Climate Change) form the core of the National Action Plan on Climate Change. Prime Minister's Council on Climate Change has approved the Jawaharlal Nehru National Solar Mission that envisages generation of 20000 mw of solar power by 2020. This Mission was launched by the Prime Minister in New Delhi on 11 January 2010. The National Mission for Enhanced Energy Efficiency, coordinated by the Ministry of Power, has also been approved. Required legislative and administrative measures are being put in place so as to implement the Mission. Drafts of other Missions have been prepared and are at various stages of consideration.

The 'Green India' project, launched by the Ministry with a view to cover six million hectares of degraded forestland through afforestation measures, is an important contribution to the objectives of the National Action Plan. It forms part of 'a Green India Mission' announced under the NAPCC.

In a Conference of the Ministers of Environment & Forests of State/UT

Governments held on 18 August 2009, addressed by the Prime Minister, the State Governments have been called upon to prepare State Level Action Plans on Climate Change (SLAPCC) consistent with the strategy outlined in the NAPCC. Accordingly, action has been initiated for preparation of SLAPCC consistent with the NAPCC in a time-bound manner. The SLAPCC will enable communities and ecosystems to adapt to climate change effectively.

Ministry has launched coordinated efforts, in collaboration with several international agencies to support the State Governments in this initiative. Three specific projects proposed by GTZ, DFID and UNDP have already been endorsed by the Ministry. The goal of the projects is to contribute to improving the livelihoods and adaptive capacities of vulnerable communities in identified States. In the first phase, Madhya Pradesh, Rajasthan, West Bengal and Tamil Nadu are proposed to be covered.

### Clean Development Mechanism

India has participated effectively in the Clean Development Mechanism (CDM) of the Kyoto Protocol. The National CDM Authority functions in the Ministry of Environment & Forests to evaluate and recommend CDM projects for host country approval. Host Country Approvals have been granted so far (January 2010) to 1551 projects in the sectors of energy efficiency, fuel switching, industrial processes, municipal solid waste and renewable energy. If all these projects get registered by the CDM Executive Board, they have the potential to generate 627 million Certified Emission Reductions (CERs) at a conservative price of US\$10 per CER, by the

year 2012 and facilitate an investment of more than Rs. 2,16,349 crores. India's CDM potential represents a significant component of the global CDM market. 478 out of the total 2011 projects registered by the CDM Executive Board in UNFCCC (Jan 2010) are from India, is the second highest by any country in the world.

CDM is an important subject of negotiations under Kyoto Protocol. India has argued that it should be strengthened and continued in the 2<sup>nd</sup> commitment period of the Protocol from 2013 as it has supported sustainable development in developing countries, while helping the developed countries meet their emission reduction targets.

### Recent Initiatives

India submits its National Communication to the UNFCCC to provide information on the GHG inventory, vulnerability assessment, adaptation, research and systematic observations, and programmes related to sustainable development. India's initial National Communication (NATCOM) was provided to the UNFCCC in 2004. This was prepared through a national effort involving more than 350 scientific personnel constituted into 131 multi-disciplinary teams.

The Ministry is engaged in the task of preparing its second national Communication with the help of over 120 scientific and research establishments and 220 scientists from all over the country. NATCOM II will be finalised in 2010 and furnished to UNFCCC in 2011. An Indian Network of Climate Change Assessment (INCCA) consisting of scientists and research institutions has also been launched by the Ministry with a view to facilitate research on climate change and

contribute to the body of knowledge on climate science and climate change assessments.

During the year, Ministry brought out a study of "India's GHG Emissions Profile: Results of Five Climate Modelling Studies" that was presented at a function held in New Delhi on 02 September 2009. The study shows that India's emissions trajectory is sustainable and India's per capita emissions will continue to be low compared to global level even in the long term due to declining energy intensity of output and autonomous changes in technology and productivity.

The Ministry, in collaboration with the United Nations Department of Economic and Social Affairs (UNDESA), organised a High Level Conference on 'Climate Change: Technology Development and Transfer' on 22-23 October 2009 in Delhi to focus on technology related issues under negotiation. The Conference, organized in association with the Federation of Indian Chambers of Commerce and Industry (FICCI) was attended by 58 country delegations and 30 Ministers from various countries and was addressed by the Prime Minister. An exhibition organised to showcase the climate-friendly technologies and services in association with the Confederation of Indian Industry (CII) was inaugurated by the Finance Minister. At the end of the Conference, a Delhi Statement on Global Cooperation in Technology was issued with a view to provide input to the climate change negotiations at Copenhagen.

Minister of State (Independent Charge), Environment and Forests, inaugurated the SAARC Clean Development Mechanism Conference in New Delhi on 1 September

2009. This Conference, jointly organized by the Ministry of Environment & Forests and the Ministry of External Affairs, in partnership with the Federation of Indian Chambers of Commerce & Industry (FICCI), was attended by the delegations from SAARC member countries Pakistan, Afghanistan, Bangladesh, Bhutan, Maldives, Sri Lanka and Nepal, besides India.

India's Five Year plans include a strategy for sustainable growth resulting in low carbon sustainable development. 11th Five Year Plan includes an indicative target of increasing energy efficiency by 20% by 2016-17. As a part of its ambitious domestic actions, Government has now declared that it will reduce emissions intensity of its GDP by 20-25% by 2020 in comparison with 2005 level. An expert panel appointed by the Planning Commission is looking into this matter and will prepare a plan of sectoral actions to achieve this objective.

### **Institutional Mechanism to Address Climate Change**

Government of India has set up an elaborate institutional mechanism to consider and address issues relating to climate change. A Council chaired by Prime Minister called Prime Minister's Council on Climate Change was constituted in June 2007 to coordinate national action for assessment, adaptation and mitigation of climate change. The Council provides the overall guidance to climate change related actions taken by various Ministries in the Government and other agencies.

The Policy Guidance Group for International Negotiations is headed by PM and consists of Ministers from the concerned

Ministries. A Core Negotiating Team of officials and technical experts undertakes the international negotiations.

An expert committee was set up in 2007 under the chairmanship of the Principal Scientific Adviser to Government to look into the impacts of climate change. This expert committee has given its first set of findings and the research agenda that the ministries need to follow and implement in order to address India's vulnerability to anthropogenic climate change impacts.

### **India's participation in International initiatives/ negotiations**

The year 2010 was marked by a flurry of activities and discussions on climate change in several international bodies and groups including G-8, G-20, MEF and Greenland Dialogue. This Ministry participated in the G-8+ Environment Ministerial meeting in Siracusa, Italy from 22-24 April 2009. Several meetings of the Major Economies Forum on Energy and Climate Change, an initiative launched by the USA were held in Washington, Paris, Mexico, and Rome in which this Ministry along with officials of the MEA, and BEE participated under the leadership of the PM's Special Envoy on Climate Change. At the Rome (L'Aquila) meeting of the MEF held in July 2009, the countries recognized the need to stabilise the climate at temperatures below 2 degree taking into account the need to ensure equity and CBDR principles and also the overriding priority of the developing countries in terms of social and economic development and poverty eradication.

One of the important events in this series was the Summit on Climate Change organised by the UN Secretary General in the UN

Headquarters at New York on 22 September 2009. This was attended by the Minister of State, Environment & Forests.

India participated in the fifteenth Conference of Parties (COP-15) held at Copenhagen from 07-18 December 2009 to discuss and reach an outcome on the climate change issues being negotiated under the Bali Action Plan and the Kyoto Protocol. An Indian delegation led by Shri Jairam Ramesh, Minister of State Environment & Forests participated in the Conference. Prime Minister also addressed the High Level Segment of the Conference on 18<sup>th</sup> December 2009. The negotiations centered on issues relating to a shared vision for long term cooperative action of the Parties including a long term emission reduction goal to address climate change, mitigation actions of the Parties including specific measures needed to reduce deforestation in developing countries and support conservation and sustainable forestry management, sectoral approaches to mitigation actions including market and non-market based measures, adaptation to climate change, finance and technology required to address climate change and technologies and the necessary mechanism needed to facilitate the flow of such support to the developing countries. An outcome of climate change negotiations as envisaged could not be reached at Copenhagen. It was decided to continue the negotiations with a view to conclude them at the next CoP scheduled to be held in Cancun (Mexico) from 29 November to 10 December 2010.

At the Copenhagen conference, the Danish Prime Minister (COP- 15 President) had called a meeting of select group of Heads of State/Government during the High-Level

Segment of the Conference, in which India participated. The meeting discussed the relevant issues and the COP President presented the results of the discussion, at his initiative, to the COP plenary in form of a 'Copenhagen Accord'. However, the COP did adopt the Accord and only took 'note' of it.

Prior to the Copenhagen Climate Change Negotiations, Brazil, South Africa, India & China had engaged themselves in regular consultations in the format of 'BASIC' to coordinate positions and take care of the interests of developing countries. Immediately after the Copenhagen Conference, the Ministry organized the 2<sup>nd</sup> Ministerial meeting of the BASIC countries' Environment Ministers' in New Delhi on 24<sup>th</sup> January 2010 to take stock of the post-Copenhagen developments and chalk out a coordinated strategy of negotiations.

### **Bilateral/other Initiatives on Climate Change**

During the year, Minister of State (Independent Charge), Environment & Forests accompanied by a delegation of officials visited China, US and Denmark to hold bilateral consultations on climate change and matters relating to environmental cooperation.

As a result of understanding reached during the Minister's visit to China, India and China signed, on 21 October 2009 in New Delhi, a Memorandum of Agreement on Cooperation on Addressing Climate Change. The Agreement is intended to enhance cooperation with China and promote mutual understanding and coordination on international issues relating to climate change, while providing opportunities for cooperation in areas of research development and diffusion

of technologies. The Agreement establishes a China-India Working Group on Climate Change for exchange of views on issues relating to domestic policies, international negotiation and implementation of related cooperation projects.

Secretary (Environment & Forests) led the India delegation to the South Asia Regional Conference on Climate Change in the Himalayan Region, organized by the Government of Nepal in Kathmandu from 31 August to 01 September 2009.

The Ministry also participated in the 31<sup>st</sup> session of Inter-Governmental Panel on Climate Change (IPCC) held during 26-29 October 2009 in Nusa Dua, Bali, Indonesia.

India engages bilaterally with several countries in the field of climate change. India has signed MOU with Italy, Canada and Denmark for promoting cooperation in the field of CDM. On 22 October 2009, India and Norway signed an MOU on Cooperation in the Area of Climate Change & Implementation of CDM Projects of Kyoto Protocol. A Joint Work Programme on Climate Change issues between India and EU is being formulated. India is also engaged in discussions with World Bank, DFID and GTZ to launch specific studies/projects for adaptation to climate change in chosen areas/regions of the country. These projects will be so designed as to ensure that they are consistent with the objectives of the National Action Plan.

As a member of the Asia Pacific Partnership on Clean Development and Climate



Fig-47. BASIC Group of Countries Environment Ministers during the 2<sup>nd</sup> Ministerial Meeting in New Delhi.

(APP-China, Japan, South Korea, Canada, USA and India), this Ministry, in coordination with the Ministries of External Affairs, Coal, and Power participated in the meetings of the APP held in Gold Coast, Australia (19-20 May) and Shanghai (26 October). The partnership focuses on development, diffusion and transfer of clean and more efficient technologies and functions through eight (8) Task Forces in the area of aluminum, buildings and appliances, cement, use of fossil energy, coal mining, power generation and transmission, renewable energy and distributed generation, and steel set up to facilitate collaboration in technology development and diffusion through public-private sector coordination.

### India's National Communication to United Nations Framework Convention on Climate Change (UNFCCC)

India is a Party to the United Nations Framework Convention on Climate Change (UNFCCC), the objective of which is to achieve

stabilization of greenhouse gas concentrations in the atmosphere at a level that would prevent dangerous anthropogenic interference with the climate system. The Convention enjoins Parties to communicate information about the implementation of the Convention, taking into account the common but differentiated responsibilities and respective capabilities and their specific regional and national development priorities, objectives and circumstances. Article 12 of the Convention relates to the communication of information pertaining to implementation in accordance with Article 4 (1) of the Convention, whereby each Party is required to communicate to the Conference of the Parties. The elements of information in the communication are provided in the context of national circumstances and include:

- A national inventory of anthropogenic emissions by sources and removals by sinks of all greenhouse gases not controlled by the Montreal Protocol, to the extent its capacities permit, using comparable methodologies to be promoted and agreed upon by the Conference of Parties;
- A general description of steps taken to implement the Convention including an assessment of impacts, vulnerability due to climate change and associated adaptation needs, and
- Any other information that the Party considers relevant to the achievement of the objective of the Convention and suitable for inclusion in its communication, including, if feasible, material relevant for calculations of global emission trends.

Towards fulfilment of obligation under the UNFCCC, India submitted its Initial

National Communication (NATCOM I) to the UNFCCC Secretariat in June 2004, within three years of receipt of financial support from the Global Environment Facility (GEF). India is now in the process of preparing its second national communication (NATCOM II) to the UNFCCC. The Ministry of Environment & Forests is both executing and implementing agency. The UNDP, New Delhi is the GEF implementing agency. A wide range of institutions covering research organizations, universities, industry associations and non-governmental organizations spread all across India and the relevant government ministries and their departments are participating in the preparation of NATCOM II.

### Progress/Achievements

The work programme of India's Second National Communication NATCOM II was launched in 2007. The key components of the work programme include (i) estimation of greenhouse gas emission inventories by sources and removals by sinks; (ii) An assessment of likely vulnerability due to climate change and development of adaptation frameworks.

### Estimation of greenhouse gas emission

A comprehensive greenhouse gas (GHG) emission inventory by sources and removals by sinks for the base year 2000 using Inter Governmental Panel on Climate Change (IPCC) guidelines is being prepared under the aegis of NATCOM II. It covers the sectors in energy, industrial processes and product use, agriculture, land use, land use change and forestry (LULUCF) and waste. The scope of improvement with reference to the inventories presented in NATCOM I include (i) estimation methodologies for some key

categories identified in ATCOM I, the effort is to move towards higher levels of estimation for these categories; (ii) refinement of GHG emission factors developed during INC; (iii) new measurements to develop country-specific emission factors for some key categories; (iv) inclusion of additional gases ( $\text{CO}$ ,  $\text{NO}_x$ , NMVOC,  $\text{SO}_2$ , HFC, PFC and  $\text{SF}_6$ ) to the extent capacities permit; (v) inclusion of additional GHG pools identified in IPCC guidelines for preparation of national greenhouse gas emission inventories that were not included in Initial National Communication (INC); and (vi) a strong emphasis on QA/QC procedures as identified in IPCC Report on Good Practices Guidance (GPG) 2000 and 2003. Country wide institutions are involved in this activity and include research institutions, universities, nongovernmental organizations and industry associations together with relevant ministries and associated departments.

#### An assessment of likely vulnerability due to climate change and development of adaptation frameworks

Under this component following activities are currently in progress include, (i) Generation of multiple climate and socio-economic scenarios at the national scale; (ii) further improvement of the national impact assessments of water resources, agriculture, forestry, natural ecosystems, coastal zones, human health with respect to INC; and (iii) Development of adaptation frameworks by undertaking integrated inter-sectoral assessment approach.

Development of adaptation frameworks are being attempted through case mode for

selected study areas covering following thematic area (a) water resources, agriculture productivity, food security and livelihoods, (b) Himalayan ecosystems and livelihoods; and (c) energy systems and infrastructure due to the changing temperature and precipitation patterns. The emphasis is to assess the current coping mechanisms operational at the local level to combat climate variability, and identify the incremental measure required to cope with the adverse impacts of climate change and develop adaptation frameworks that may be useful in the context of development of a national framework for adaptation.

#### Capacity Building and Monitoring

Training workshops have been organized for enhancing capacity of the researchers for undertaking various activities. Also progress of work in each activity is being monitored through sectoral consultative meetings, through workshops and at the apex level by the National Steering Committee of the project. Regular monitoring of progress is also being undertaken to incorporate mid course corrections if any. A Review Workshop was organized on 13<sup>th</sup> October 2009 to review the progress of all activities undertaken under the aegis of NATCOM II under the Chairmanship of Hon'ble MEF.

#### Indo-UK Collaborative Research Programme – Phase II (Impact and Adaptation)

This is a joint collaborative research programme between the Government of United Kingdom, Department of Energy and Climate Change (formerly, Department of Environment, Food and Rural Affairs) and the Ministry of Environment and Forests, Government of India. The objective of the research programme is

to improve climate scenarios, quantifying and reducing uncertainty in the impacts, and introducing consideration of elements of adaptation in a regional project, with some stake-holders involvement.

The project aims at further advancing collaborative research project between India and the UK in order to undertake a detailed assessment of potential impacts of climate change on India, including the socio-economic impacts of extreme events, and to undertake two pilot projects to identify adaptation options at the regional scale. Phase- II of the project will also update the previous findings with better resolution along with on-ground adaptation study in vulnerable regions. In addition, it envisages training and institutional capacity building through establishment of links between Indian and UK institutions for developing training opportunities relevant to the study.

The final projects identified for Phase-II of the Indo-UK Collaboration include

- Development and dissemination of High Resolution climate change scenarios for India

- Linking water and agriculture in river basin and impacts of climate change
- Development of socio-economic scenarios of climate change
- Assessment of state level vulnerability and adaptation – a case study in Orissa
- State level vulnerability and adaptation assessment – a study in Madhya Pradesh.

Socio-economic impacts of climate extremes.

A Steering Committee co-chaired by the representatives of MoEF and Department of Energy and Climate Change, UK oversees the development and implementation of the Phase-II programme.

During the period under report, the Phase-II of the project was launched on 11<sup>th</sup> and 12<sup>th</sup> May 2009. The institutions responsible for undertaking research activities on various components viz., climate change scenarios, national level study on impacts and vulnerability, socio-economic impact and extreme events and adaptation response to climate change in the States of Orissa and Madhya Pradesh are given as follows.

<b>Name of the Institutions</b>	<b>Area of research</b>
Indian Institute of Technology, Delhi.	Linking water and agriculture in river basins: Impact of climate change.
Indian Institute of Tropical Meteorology, Pune	Development and dissemination of high resolution climate change scenario
Winrock International India, Delhi	Assessment of state level vulnerability and adaptation – a case study in Orissa
Development Alternative, New Delhi	State level vulnerability and adaptation assessment – a study in Madhya Pradesh.
Indian Institute of Management, Ahmedabad	Socio-economics



### Indian Network of Climate Change Assessment (INCCA)

This programme launched by Hon'ble Minister (Environment & Forests) Shri Jairam Ramesh on 14<sup>th</sup> October 2009. It is a network based programme to be coordinated by this Ministry to undertake more ambitious programme of climate change assessment. This has been an endeavour, bringing together Institutions and Scientists from across the country. The results of the various studies are being undertaken to enhance understanding of the phenomenon of climate change and its impact on various sectors of the Indian economy and society. This programme will cover significant aspect related to climate change, including, for example, the study of black carbon and the impact of climate change on glaciers and on rainfall patterns. The major elements of the programmes on Sectoral Assessment include:

- Climate Change scenarios for 2030
- Impact assessment at national level on water resources, agriculture, forests, energy, coastal zone and human health.
- Integrated impacts and vulnerability assessment
- Developing adaptation frameworks

The studies will be undertaken for four major regions of the country, viz., Himalayan Region, Western Ghats, North Eastern Region and Coastal areas. The result of the study will be made available in the public domain for peer review, discussion and debate. Further, this programme will provide capacity building to create and nurture the next

generation of climate change scientists and experts.

The institutional arrangement for impact, vulnerability and adaptation assessments has been designed to address the components of the programme from among the existing network of Institutions.

The programme also envisages preparing a comprehensive GHG emission inventory profile by sources and removals by sinks for India. It is being developed using comparable methodologies (IPCC 1996/2006).

### Intergovernmental panel on Climate Change (IPCC)

The Intergovernmental panel on Climate Change is a specialized body jointly established by the United Nations Environment Programme and World Meteorological Organization mandated to prepare scientific assessments on various aspects of climate change. The IPCC has been entrusted with the task of preparing its Fifth Assessment Report on Climate Change, inter-alia, the physical science basis; impacts, vulnerability and adaptation; and mitigation of climate change based on the published peer-reviewed literature worldwide after the publication of its Fourth Assessment Report brought out by the IPCC in the year 2007. As a nodal ministry in the Government for the IPCC, the objective of this programme is to undertake and facilitate implementation of various activities of the IPCC at both international and national level.

The IPCC at its 31<sup>st</sup> Session held in October 2009, accepted the outlines of the Chapter for its next assessment report on various aspects of climate change viz., the

physical science basis of climate change; impacts, vulnerability and adaptation and mitigation of climate change. An Inter-Ministerial delegation participated in the various meetings of the IPCC.

### Ozone Layer Protection

#### Introduction and Objectives

- Ozone, a tri-atomic molecule is formed naturally in the upper level of the Earth's atmosphere by high-energy Ultraviolet (UV) radiation from the sun. The radiation breaks down oxygen molecules, releasing free atoms, some of which bond with other oxygen molecules to form ozone. About 90 per cent of all ozone formed in this way lies between fifteen and fifty five kilometers above the Earth's surface, called the Stratosphere.
- The stratospheric Ozone Layer absorbs all the harmful UV radiations emanating from the Sun. It protects plant and animal life from UV radiation. The UV radiation has the potential to cause skin cancer, eye cataract, suppress body's immune system, decrease crop yield etc. which led to the adoption of the Vienna Convention for the Protection of the Ozone Layer in 1985 and the Montreal Protocol on Substances that Deplete the Ozone Layer in 1987 along with its four Amendments. In India, provisions of the Montreal Protocol and its London Amendment came into effect from September 17, 1992. India also ratified the Copenhagen Amendment (1992), the Montreal Amendment (1997) and the Beijing Amendment (1999) on March 3, 2003.
- India was self sufficient in production of Chlorofluorocarbons (CFCs). India was mainly producing and using nine of the ninety five substances controlled under the Montreal Protocol. These are CFC-11, CFC-12, CFC-113, Carbontetrachloride (CTC), Hydrochlorofluorocarbons-22 (HCFC-22), Halon-1211, Halon-1301, Methyl Chloroform and Methyl Bromide. These Ozone Depleting Substances (ODS) are used in refrigeration and air conditioning, foams, fire fighting, aerosol, fumigation and cleaning applications etc.
- The Government of India has entrusted the work relating to the Ozone layer protection and implementation of the Montreal Protocol to the Ministry.
- A detailed India Country Programme for phase out of ODS was prepared in 1993 to ensure the phase out of ODS according to the National Industrial Development Strategy, without undue burden to the consumers and the industry and for accessing the Protocol's Financial Mechanism in accordance with the requirements stipulated in the Montreal Protocol. The Country Programme was updated in 2006. The Executive Committee (Ex-Com) of the Multilateral Fund (MLF) at its 49<sup>th</sup> meeting held in July 2006 had approved the Country Programme Update for India.
- The Ministry has set up the Ozone Cell as a National Ozone Unit to look after and to render necessary services to implement the Protocol and its ODS phase-out programme in India. The Ministry has established an Empowered Steering Committee (ESC) Chaired by the Secretary

(E&F) which is supported by the Standing Committees. These Committees are responsible for the implementation of the Montreal Protocol provisions, review of various policy and implementation options, project approval and project monitoring.

### Activities undertaken so far

- India has taken a series of fiscal and regulatory measures to facilitate ODS phase-out in the country. Among fiscal measures taken, Government has accorded customs and excise duty exemptions on goods required for ODS phase-out projects and new investment and expansion of established industries with non-ODS technology. In the current financial year i.e. 2009-10 only benefit of customs duty has been given for the above purpose. The Reserve Bank of India has issued directions to all financial institutions and commercial banks not to finance new establishment with ODS technology. Trade in ODS with non-Parties to the Protocol has been banned. All ODS have been brought under the ambit of licensing for purpose of both imports and exports. Import of CFCs in India has been banned.
- Awareness activities at the national and state level were organized to sensitize the stakeholders to phase-out the ODS in various sectors. The International Ozone Day function is being organized every year in the country on 16<sup>th</sup> September.
- “Montreal Protocol: India’s Success Story”, posters, stickers are brought out every year on the occasion of International Ozone Day giving latest information on ODS phase-out in the country and technologies adopted.
- A bi-monthly newsletter viz. ‘VATIS UPDATE-Ozone Layer Protection’ is being published giving latest information on the science of ozone and the technical options evolved and used in various sectors all over the globe.
- Training Programs for customs and other enforcement officers were organized.
- Training workshops for refrigeration servicing technicians on good service practices to reduce CFC consumption in servicing sector were organized.
- Participated in the meeting of the Ex-Com, Open Ended Working Group (OEWG), Meeting of the Parties (MOP) and other related meetings.
- Data on production, consumption, export, import of ODSs is being submitted to the Ozone Secretariat by end of September every year.
- Project Management Unit (PMU) was set up in 2002 to implement the CFC and CTC National Phase-out Plans.
- The phase-out of HCFCs was accelerated by ten years with certain reduction schedule vide decision XIX/6 of the 19<sup>th</sup> MOP in 2007. This will be a challenging task as HCFCs are widely used in various applications like refrigeration and air-conditioning, foam manufacturing, solvents, fire extinguishing etc. India has made a number of innovative efforts to meet the challenges of accelerated phase-out of HCFCs.
- A comprehensive Roadmap to Phase-out HCFCs in various sectors in India has been developed.



Fig-48. Hon'ble MoS (I/C) for Environment and Forests delivering his speech on the occasion of International Ozone Day, 2009.

#### Awards & Appreciations received so far

- The United Nations Environment Programme, on the occasion of 20<sup>th</sup> Anniversary of the Montreal Protocol, Conferred "The Montreal Protocol Implementers Award, 2007" to the 'Ozone Cell of India' in recognition of extraordinary contributions in the effective implementation of the Montreal Protocol and the global effort to protect the Ozone Layer.
- The United Nations Environment Programme, on the occasion of 20<sup>th</sup> Anniversary of the Montreal Protocol, Conferred "The Montreal Protocol Exemplary Project Recognition" to the 'Ozone Cell of India' for its contribution to the Exemplary Project "Foam Sector Umbrella Project for Conservation to CFC-Free Technology". In addition to this, 'Ecological Refrigeration (ECOFRIG)', 'Human and Institutional Development in

Ecology Refrigeration (HIDECOR)' and 'National CFC Consumption Phase-out Plan (NCCoPP)' and two Industries viz. 'M/s. Kirloskar Copeland Ltd.' And 'M/s. Satya Deeptha Pharmaceuticals' also got the Montreal Protocol Exemplary Project Recognition Award.

- "The Stratospheric Ozone Protection Award, 2008" was conferred to Dr.A. Duraisamy, Director, Ozone Cell in recognition of his exceptional contribution to global environmental protection and for leadership in Ozone Layer protection by United States Environmental Protection Agency, Washington, DC.

#### Awareness Activities

- The UN General Assembly on 23<sup>rd</sup> January, 1995 adopted a resolution 49/114 which

proclaims 16<sup>th</sup> September as the International Day for the Preservation of the Ozone Layer, to commemorate the signing of the Montreal Protocol on Substances that Deplete the Ozone Layer which was signed on 16th September, 1987. The International Day for the Preservation of the Ozone Layer is celebrated at national and state levels since 1995.

- The Fifteenth International Day for the Preservation of the Ozone Layer was celebrated in Delhi on 16th September, 2009. The theme of this year's International Ozone Day was "Universal participation : Ozone protection unifies the world". Shri Jairam Ramesh, Hon'ble Minister of State for Environment and Forests (Independent Charge) was the Chief Guest. Around five hundred fifty school children, policy makers, technocrats and government officials attended the function.
- On this occasion poster, painting, skit competitions were organized among school children. Prizes for the best three in each competition were given. The publication "Montreal Protocol: India's Success Story" was released and distributed to the participants on this occasion.

### Achievements

- India has met the following compliance targets as per the control schedule of the Montreal Protocol:-
  - Freeze of CFC production and consumption in July, 1999 at 22588 ODP tons and 6681 ODP tons respectively.
  - Freeze of Halon production and consumption on January 1, 2002.

- Total phase-out of Halon production in 2003.
- Phase-out of 85% production and consumption of CTC as on January 1, 2005.
- Accelerated phase-out of production of CFCs w.e.f August 1, 2008, seventeen months earlier than the phase-out schedule of the Montreal Protocol .
- Phase-out of consumption of CFCs in all applications as on January 1, 2010 except in manufacturing of Metered Dose Inhalers (MDIs) for Asthma and Chronic Obstructive Pulmonary Disease (COPD) patients.
- The Ex-Com of the MLF had approved a total of two hundred ninety nine projects involving MLF funding of about US \$349 million for phasing out 25000 ODP tons of production and 23000 ODP tons of consumption of ODS.
- In 2009 during 57<sup>th</sup> to 59<sup>th</sup> meeting of the Ex-Com of the MLF, US\$ 12.1 million were approved for implementation of 2009 Annual Work Plan of CTC Phase-out Plan for the consumption and production sectors and accelerated CFC production Phase-out.
- Training, workshops were organized for service technicians on good servicing practices and retrofitting of CFC based refrigeration appliances to non-CFCs. The technicians were drawn from both formal and informal sectors. More than 10,000 technicians have been trained under the National CFC Consumption Phase-out Plan (NCCoPP).

- The equipment support has been provided to the trained technicians under NCCoPP to use good servicing practices in the field which has resulted in reduction of use of CFCs in servicing sector.
- Reclamation units have been provided at a number of places and organizations including Indian Railways to recover, reclaim and reuse the CFCs.
- In 29<sup>th</sup> meeting of the OEWG, the India proposed that Indian producers can produce pharmaceutical-grade CFCs for manufacturing of MDIs used by Asthma and COPD patients for EUN to meet its own requirements as well as for other to meet the basic domestic needs of other Article 5 Parties and submitted Conference Room Paper (CRP) on EUN and campaign production. The OEWG forwarded in square brackets a draft decision prepared by the Contact Group based on the India's CRP to the 21<sup>st</sup> MOP.
- The Chairman of the 58<sup>th</sup> Ex-Com formed a Contact Group to discuss the various issues related to cost consideration for financing the HCFC phased-out in Article 5 Parties. India played a vital role in the deliberations during the Contact Group and expressed willingness to accept the cut-off date, 16<sup>th</sup> September 2007, the date of decision XIX/6 (accelerated phased-out of HCFCs) which was emerging as consensus. India also made a proposal for a comprehensive analysis to develop policies to define eligible incremental costs for HCFC phase-out.
- The 21<sup>st</sup> MOP to the Montreal Protocol on Substances that Deplete the Ozone Layer was held in Port Ghalib, Egypt from November 4 to 8, 2009. The Indian delegation was represented by Dr. B.P. Nilratna, Joint Secretary, MoEF and Dr. A. Duraisamy, Director, Ozone Cell, MoEF. An Amendment was proposed by a number of Member Countries including USA and Canada to bring Phase-down of HFCs under the ambit of a Montreal Protocol. India was not in favour of this Amendment as it adversely affects the Indian Industries. Indian delegation during the 21<sup>st</sup> MOP made tireless effort to oppose the proposed Amendment.
- India made a very comprehensive well structured intervention and raised legal, policy and technical issues against the proposed amendment of bring HFCs under the ambit of the Montreal Protocol. Most of the Parties especially the Article 5 Parties referred the intervention made by India while making the interventions. Finally, the amendment to the Montreal Protocol was not agreed in the 21<sup>st</sup> MOP.
- The draft decision based on India's CRP in 29<sup>th</sup> OEWG was discussed in detail at the 21<sup>st</sup> MOP in a Contact Group. India played a very vital role on behalf of all the Article 5 MDI manufacturing Parties during the discussion. Based on the interventions made by the Indian delegation the Contract Group recommended a draft decision which has a number of elements including review of Production Sector Agreements of India and China with the Ex-Com to allow these two countries to produce pharmaceutical grade CFCs for manufacturing of MDIs in their own countries as well for export CFCs to other MDI manufacturing countries.

- India has been elected as the Member of the Ex-Com for the year 2010 and will have China, Malaysia and Indonesia as its Co-opted Members..
- The following workshops were conducted during this year:
  - A workshop on ODS Phase-out in Defence Applications was held on 29th April, 2009 at New Delhi.
  - Sectoral Working Groups Meeting for preparation of HCFC Phase-out Management Plan (HPMP) in India was held on 24th and 25th September, 2009 in New Delhi. The Meeting was very well attended by the stakeholders from Industry, Industry Associations Research

Organizations, NGOs and concerned Government Organizations. The Working Groups especially the Refrigeration and Air-conditioning Manufacturing, Foam manufacturing discussed the various strategies to implement the Road Map for phasing-out the HCFCs in India.

- One Day National Awareness Workshop on "CFC MDI Phase-out Transition Strategy Implementation and Adoption of CFC free Alternatives in India" was held on 5th October, 2009 in New Delhi.
- Launching of Roadmap for Phase-out of HCFCs in India was held on 6th October, 2009 in New Delhi. On this occasion, Shri Jairam Ramesh, Hon'ble Minister of



Fig-49. Launching of Roadmap for HCFC Phase-out in India

State for Environment and Forests (IC) released the Roadmap for Phase-out of HCFCs in India.

- The objective of the Roadmap is to phase out Production and Consumption of HCFCs in various applications as per the reduction targets of the Montreal Protocol in a well coordinated manner without any commercial and financial dislocations in the country.
- Open Type compressor (OTC) workshop on good practices & servicing were held in different states of India.
- National Academy of Customs Narcotics and Drugs (NACEN) and Ozone Cell organized training programme for customs officers as part of Policy and Customs training project in the RTIs of NACEN.

### Regulatory Measures

- The Ozone Depleting Substances (Regulation and Control) Rules, 2000 under the Environment (Protection) Act, 1986 has been notified in the Gazette of India on July 19, 2000. These Rules set the deadlines for phasing out of various ODS, besides

regulating production, consumption, trade, import and export of ODS and the products containing ODS. The ODS Rules were amended in 2001, 2003, 2004, 2005 and 2007 to facilitate implementation of ODS phase-out by the enterprises in various sectors.

- These Rules prohibit the use of CFCs in manufacturing various products beyond January 1, 2003 except in MDI and other medical purposes. Other ODS such as CTC, halon, methyl chloroform will be used upto January 1, 2010. Further, the use of methyl bromide has been allowed upto January 1, 2015. Since HCFCs are used as interim substitute to replace CFCs, these would be allowed upto January 1, 2030.
- The latest amendment to the rules, have defined feedstock use of ODS and extended the date of registration for enterprises using ODS.

### Fiscal Measures

- Customs and Excise duty exemption have been extended for MLF assisted ODS phase-out projects or expansion of capacity with non-ODS technology during the financial year 2009-2010.





**CHAPTER - 14**  
**ADMINISTRATION AND**  
**CIVIL CONSTRUCTION**

## Personnel Administration

### Staff Position

The staff strength of the Ministry including NAEB, NRCDC is eight hundred seventy four. The details of the posts are given in Table-30.

function as a separate, distinct, centralized and confidential unit for the purpose of recruitment (through Direct Recruitment/ Deputation) as well as promotion under FCS (Flexible Complementing Scheme) in the Group 'A' Scientific Posts for the Ministry, its Regional

Table-30. Number of employees in various groups and with reservation position

Group of Post	Sanctioned Strength	Number in Position	Scheduled Caste	Scheduled Tribe	OBC	Physically Handicapped
A	169	155	14	02	03	02
B	264	221	27	07	07	01
C	441	325	97	14	19	09
<b>Total</b>	<b>874</b>	<b>701</b>	<b>138</b>	<b>23</b>	<b>29</b>	<b>12</b>

The Ministry has outsourced some clerical jobs to tide over the shortage of the staff during the year.

Offices and all the attached/subordinate offices having such posts in their organizations.

### Recruitment and Promotion of Scientists

Following the re-organisation of the Scientific/Departments/Ministries during 1986 and consequent de-linking of the Group 'A' Scientific posts for the purview of the UPSC and introduction of Flexible Complementing Scheme (FCS), P-III Section was specifically conceived and created in the Ministry to

### Review and Promotion under FCS

Under the Flexible Complementing Scheme (FCS), involving a two-tier system of evaluation for review/assessment of the Scientists for their promotion, the screenings/ interviews of Scientists, conducted during the current year are given Table-31.

Table-31. Review and assessment of scientists for promotion

Organization	Scientists considered for screening	No. of Scientists screened in for interview	No. of scientists successful in the interview
Ministry Proper	03	03	03
Botanical Survey of India	08	06	06
National Museum of Natural History	03	03	03
National River Conservation Directorate	01	0	0
Zoological Survey of India	07	05	01

## Recruitment

During the current year, nine posts of Scientist 'C' in Botanical Survey of India were filled by Direct Recruitment.

In addition to the above, the process to fill up the eleven posts of Scientist 'C', two posts of Scientist 'D' and one post of Scientist 'E' in Ministry Proper including Regional Offices, eleven posts of Scientist 'C' in Botanical Survey of India, three posts of Scientist 'B' and one post of Scientist 'D' in National Museum of Natural History, one post of Scientist 'C' in National River Conservation Directorate and two posts of Scientist 'C' in Directorate of Forest Education is underway.

## General Administration

The General Administration (GA) Division of the Ministry is entrusted with the responsibility of procurement of stationery, stores and equipment for functioning of the Ministry and providing essential services to the personnel of the Ministry including transport, communication, general upkeep etc. Some of the major initiative/activities of the Division during the year are (i) implementation of the process of requisition and issue of stationery and stores through the Material Requisition Information System (e-poorty) development by the NIC; (ii) renovation of the 5<sup>th</sup> Floor B2 wing of Preyavaran Bhawan, which was devastated in a fire in April, 2009. The office space measuring about 4000 sq. ft. has since been renovated through the CPWD as an open office system with modern facilities; (iii) the Ministry has acquired about 9000 sq. mtr. of land at Aliganj, Jorbagh Road, New Delhi for construction of its own office building. The Ministry has decided to adopt sustainable energy efficient environment friendly green

building technology which will serve as a model for others to emulate not only within the country but also in the other parts of the world. The Division is working in tandem with various agencies involved in the project to complete the building as early as possible.

## Indian Forest Service (IFS) Cadre Management Division

### Mandate

- The Indian Forest Service (IFS) Cadre Management Division is enjoined upon to handle the business of the Ministry as the Cadre Controlling Authority for the Indian Forest Service (one of the three All India Services).
- The total authorized cadre strength of the Indian Forest Service as on 1.10.2009 is three thousand seven which includes two thousand ninety six Direct Recruit and nine hundred eleven Promotion posts. The Total Senior Duty Posts (SDP) in the Indian Forest Service are one thousand eight hundred thirty four and the remaining under various reserves. Besides serving the thirty one Forest Departments in the States and Union Territories managing the country's natural resources, a good number of them work in various Ministries and institutions both in the State and Central Government.

Main activities of the IFS Cadre Management are :

- Determination of vacancies and framing of rules for Direct Recruitment and allocation of cadres to IFS probationers.
- Determination of vacancies for induction of State Forest Service Officers by promotion into Indian Forest Service, coordination of Selection Committee Meeting, Promotion and Determination of Seniority.

- Cadre Review for revision of composition and strength of IFS in various cadres.
- Selection/appointment of IFS officers to various posts under the Central Staffing Scheme of the Ministry and to various autonomous bodies including Indian Council of Forestry Research & Education, Dehradun; Indian Institute of Forest Management, Bhopal and Wildlife Institute of India, Dehradun.
- Facilitation of Selection/Appointment of IFS officers against the Central Staffing Scheme of the Department of Personnel & Training (DoPT).
- Finalisation of various service matters like inter-cadre transfers, inter-cadre deputations, cadre clearance for placements/trainings and post retirement benefits to the officers.
- Management of AGMUT cadre including promotions, transfers, postings and other service matters.

### Progress/Achievements during the year

- The IFS Cadre Management Division of the Ministry deals with the broad items of work relating to the Indian Forest Service.
- Direct Recruitment to the Indian Forest Service.
- Allocation of IFS Probationers to various State cadres.
- Up-to-date Civil List of IFS officers is available on the website of this Ministry at [www.ifs.nic.in](http://www.ifs.nic.in) besides, vacancy circulars, training programme circulars, Rules and Regulations concerning IFS, ACR availability status of IFS officers are also hosted on this site for the benefit of the members of the Service. Each and every member of Service has been provided facility to have his unique e-mail account through NIC on this site and members of Service have been provided facility to update the date relating to their posting details online for periodical upgradation.
- Eighty four Direct Recruit officer on the basis of IFS Examination, two thousand eight were inducted into the Service.
- Thirty six State Forest Service officers were inducted into the Indian Forest Service under IFS (Appointment by Promotion) Regulations, during the year 2008-09.
- About thirty seven IFS officers joined at various levels under the Central Staffing Scheme of the Ministry and about ten IFS officers joined under the Central Staffing Scheme of the Department of Personnel & Training
- Meeting of the Cadre Review Committee were held to review the strength and composition of 11 cadres, namely AGMUT, Manipur-Tripura, Rajasthan, Nagaland, Uttarakhand, Gujarat, Andhra Pradesh, Tamil Nadu, Sikkim, Uttar Pradesh and Maharashtra.
- Thirty-seven Court Cases pending in various Courts across the Country were liquidated. Around two hundred fifty Court cases relating to the issues of IFS Cadre are pending in various Tribunals/Courts all over the Country.
- For the first time, on line system for filling up of the deputational posts under CSS introduced.
- Scanning of the ACRs of almost one thousand eight hundred (out of two thousand eight hundred twenty six) officers was completed

and maintained in electronic form along with hard copies.

## Vigilance

The Vigilance Division is responsible for all vigilance/disciplinary matters relating to the Indian Forest Service officers both in the Ministry including its attached and subordinate offices, autonomous organizations/PSUs & IFS officers posted in the State Governments. The Vigilance Division functions under the direct control of Joint Secretary & Central Vigilance Officer (CVO) and overall supervision of Secretary, Environment & Forests.

The Vigilance Division is responsible for examination and processing of Disciplinary Cases, Appeals, Reviews and Memorials of Indian Forest Service Officers of all States/ Union Territories, Investigation of Complaints, Obtaining & Maintenance of Annual Immovable Property Returns etc. Cases filed in various Benches of Central Administrative Tribunal and Courts in India in connection with the disciplinary matters are also handled in Vigilance Division. The prosecution cases launched against IFS Officers by various States/Union Territories and also other Officers/Staff of the Ministry are also dealt with in Vigilance Division.

The Division requires frequent consultation with the Central Bureau of Investigation, Central Vigilance Commission, Union Public Service Commission (UPSC) and Department of Personnel and Training (DOPT) as per rules and procedures laid down on the matter.

During the year, thirty one Disciplinary Proceedings cases, seventeen Appeal cases

and seven Prosecution cases were processed in the Vigilance Division. Of these, three Disciplinary cases, eight Appeal cases and two Prosecution cases were finally disposed of. Court cases were pursued in the respective court/CAT Bench. Out of thirty six complaints received through CVC, eight complaints were finally disposed of after obtaining and considering the investigation reports. Other complaints are at various stages of investigation/examination. Twenty three complaints received from other sources were also closed during the year. Applications received under RTI Act were also processed and replies sent to the applicants. The progress on the disposal of DP, Appeal, Prosecution, Court cases and RTI cases as well as complaints is reviewed by JS&CVO from time to time.

About two hundred eighty seven Annual Property Returns as on 01.01.2009 were received from Group 'A' & 'B' officers of the Ministry as well as organisations under it, of which one hundred eighty two APRs were scrutinised till the end of December, 2009.

Based on the sensitive posts already identified in the Ministry, rotational transfers of officers and staff who have put in three years or more in a sensitive post, are made. Sensitive posts have also been identified in various field organisations and rotational transfer from sensitive posts are effected in these organisations as and when required.

Vigilance Awareness Week was observed in the Ministry during the period from 3rd November, 2009 to 7th November, 2009 and a pledge was administered by Secretary (E&F) to the officers & staff to

bring about integrity and transparency in all spheres of activities and to work unstintingly for eradication of corruption in all spheres of life.

Monthly Report on the cases relating to prosecution sanctions, disciplinary proceedings, complaints etc. was regularly sent to the CVC during the year.

### Parliament

#### Introduction

The Parliament Division in the Ministry is responsible for co-ordination of all parliament matters related to the Ministry.

#### Progress of Activities undertaken

During the current year, a total number of seven hundred fifty one Parliament Questions pertaining to various aspects were answered by the Ministry (four hundred nine questions in the Lok Sabha, forty five starred and three hundred sixty four unstarred and three hundred forty two questions in the Rajya Sabha, thirty three starred and three hundred nine unstarred). The questions covered a wide range of issues with which the Ministry is concerned, prominent among them being a wider range of issues with the Ministry is concerned such as Wildlife Management, Pollution, Forest Conservation, Freshwater & Marine Conservation, EIA, Climate Change & Meteorology & Environmental Conservation etc.

The report on the Parliament Questions replied during the year 2009 by the MoEF and other Ministries is under process and will be published shortly by ENVIS Centre. The present report serves as a helpful source of

document for policy makers, academicians and researchers interested in Parliamentary studies as well as for those, who are keen to bring environmental issues to the forefront of Government policies.

The graphical presentation of the Parliament Questions replied to by the MoEF during 2009-10 both in Lok Sabha and Rajya Sabha in various sessions are given in Fig.-50 and Fig.-51.

During the year 2009-10 one meeting of the Consultative Committee of Members of Parliament attached to the Ministry was held on the subject Copenhagen Accord. The meetings of the Department related Parliamentary Standing Committee of Science and Technology, Environment and Forests of the Members of the Parliament were held on different subjects on different occasions.

#### Internal Work Study Unit (IWSU)

Activities relating to internal work study are coordinated by Internal Work Study (IWS) Unit of the Ministry. This is to ensure timely action by various sections on proper record management and strict compliance of various provisions of the manual of office procedure.

#### Progress/ Achievements made during the year

- During the year, one thousand five hundred eleven files were sent for review from Departmental Record Room (DRR) and three thousand two hundred eighty eight files received in DRR for retention.
- In order to have a quick retrieval system and an accurate and permanent data base, the computerization of all the files in the

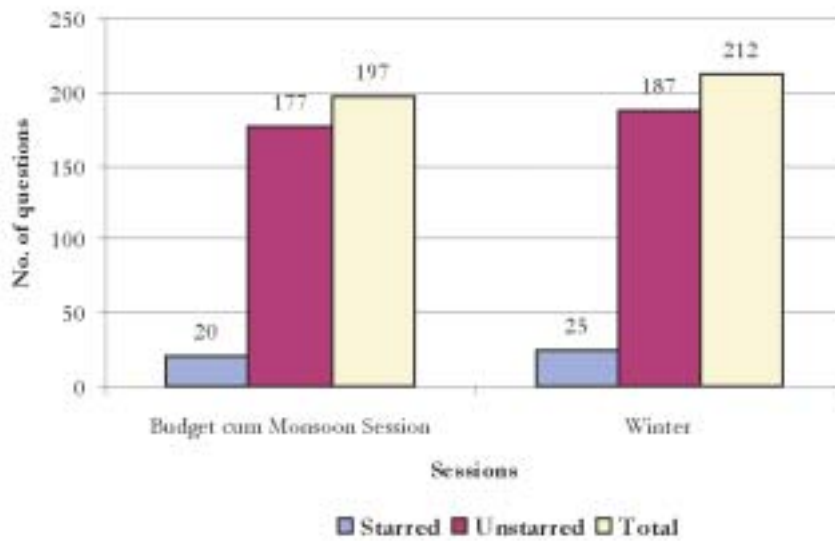

Fig-50. Number of questions replied to by the Ministry in Lok Sabha during 2009-2010

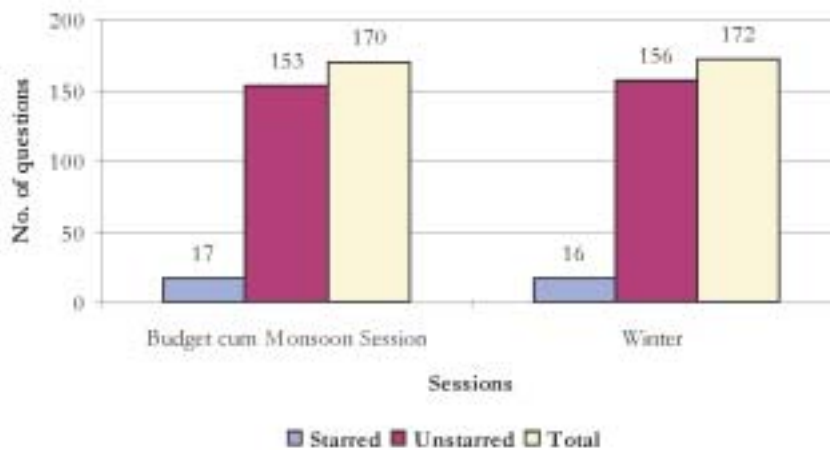

Fig-51. Number of questions replied to by the Ministry in Rajya Saha during 2009-2010

DRR has been completed through development of software. This is very helpful in monitoring the record management in the Ministry. So far, the DRR has completed computerization of more than twenty one thousand files.

- One thousand three hundred eleven recorded files of category 'B' or files live for twenty

five years or more have been identified for appraisal to be done by National Archives of India (NAI), New Delhi.

- Work Measurement Study of scientific and non-scientific posts in the Ministry including NAEB and NRCD, by the Work Measurement Committee with a core-member from Staff Inspection Unit (SIU), Department of Expenditure, is under process.

- O&M inspections of the organizations under the Ministry and Sections/Divisions of the Ministry is being completed.

- Records Retention Schedule for substantive functions of the Ministry has been prepared and forwarded to National Archives of India for their vetting.

- Review of 'Channel of Submission and Level of Final Disposal of Case' for the Ministry has been completed and is available on the Ministry's website.

## Information Technology and e-Governance

The Government has recognized Information Technology (IT) as a major important tool for speedy implementation and monitoring of various schemes and decisions in public interest. Accordingly, Ministry has

embarked on a comprehensive exercise to implement an e-Governance project titled 'ENVISION' with the objective of transforming the functioning of the Ministry and its constituent organizations, and also to transform the way the Ministry serves its various stakeholders.

e-Governance project of MoEF called ENVISION is "to apply the principles of good governance – transparency, rationality, accountability, reduction in time and costs, ease and convenience of citizens and businesses in accessing the information and services provided by the Ministry through different channels e.g. internet.

It seeks to render services to its various stakeholders with accurate, timely and reliable information and develop a more friendly and hospitable interface with public.

Project is to be implemented in three Stages:

- Stage 1 (Conceptualization) includes development of vision and objectives, determine scope of transformation envisaged and selection of a suitable consultant through a competitive bidding process. National Institute for Smart Government (NISG) was engaged for preparing the Request for Proposal (RFP) which led to the engagement of Stage 2 consultants for the Business Process Reengineering (BPR) exercise as well as implementation of Proof of Concept (PoC) for the identified processes.
- Stage 2 (Project Development) M/s PricewaterhouseCopers Pvt. Ltd. (PwC) engaged as Stage 2 consultants undertook detailed study of the 'AS-IS' processes and has designed the 'TO-BE' processes under the domain of BPR exercise for regulatory,

functional and promotional activities leading to ease access to information through a website ensuring paperless office. To corroborate soundness of the concept, selected processes will be taken up for Proof of Concept (PoC) implementation.

- Stage 3 (System Integration and Project Implementation) The Ministry invited Expression of Interest (EOI) from the System Integrators to implement and maintain ENVISION solution based on the qualification criteria for submission of such proposals and short-listed seven organizations.

### Progress/Achievements made during the year

- Request for Proposal for Stage 3 consultant was reviewed and circulated to the short-listed firms. The Pre-Bid meeting was organized and the minutes of the meeting was circulated for submission of Techno-commercial bids. After the receipt of Technical and Financial Bids, evaluation of technical bids was held and financial bids of the technically qualified bidders were opened.
- Implementation of Proof-of-Concept for Leave, GPF, Environmental Clearance and Wetland Scheme has been completed and the software applications have been demonstrated to the concerned Divisions.
- The IT infrastructure at the Ministry, BSI, Kolkata, ZSI, Kolkata and Andaman & Nicobar Forest Plantations and Development Corporation, Port Blair was strengthened.
- Based on the Training Needs Analysis, the Ministry had developed a comprehensive proposal for training of over five thousand



employees in both IT and Non-IT domains. The Request for Proposal was circulated and the pre-bid meeting was organised. The Technical and Financial bids were received and agency was finalized after the due evaluation processes. The IT training was provided to about one thousand officers and staff of the Ministry and the attached offices.

- Proposal for selection of agency for Scanning Digitisation of Old Archival Documents at Botanical Survey of India, Kolkata have been finalized. The agency was selected through Tendering process and the work of scanning digitization started.
- Proposal for selection of agency Photographic digitization of Textile Designs, Natural Dyes and Illustrations in the old archival documents at Botanical Survey of India, Kolkata have been finalized. The agency was selected through Tendering process and approval in the Ministry are under process.
- Process for establishment of Programme Monitoring Unit (PMU) initiated and the room has been renovated.
- For scanning and digitization of records in the Ministry, the Tender document was published. The Techno-commercial bids were received and the evaluation of technical bids is under process. The IT infrastructure including servers and storage system procured and installed.
- The re-structuring and re-designing of the website of the Ministry have been completed.

### RTI Cell

Activities relating to implementation of

RTI Act, 2005 are coordinated by RTI Cell of the Ministry.

### Progress/ Achievements made during the year

- The Ministry has received nine hundred twelve RTI applications and eighty two appeals under RTI Act, 2005 (from Jan.,2009 to 31<sup>st</sup> Oct.,2009).
- For effective implementation of RTI Act, 2005, Central Public Information Officers (CPIOs) and Appellate Authorities (AAs) have been designated. The notification designating CPIOs/AAs is revised periodically as and when there is change in allocation work of CPIOs/AAs.
- A workshop on effective implementation/ understanding of RTI Act, 2005 was organized on 11<sup>th</sup> November, 2009 for the staff and officers up to the level of Joint Director in the Ministry.
- Decisions of Central Information Commission (CIC) and DoPT, relevant to this Ministry are being circulated to the CPIOs/AAs for better understanding.
- All the Subordinate Offices / Institutions / Autonomous bodies have been requested to periodically revise the notification for CPIOs/AAs.
- Reports being sent regularly to DoPT and Central Information Commission.

### Protocol Unit

- Providing comprehensive protocol arrangements for Minister of Environment and Forests, Secretary, Special Secretary and Director General of Forests and Special



## Ministry of Environment & Forests

Secretary and Director General of Forests and Special Secretary (DGF&SS);

- Obtained one hundred forty five visas of senior officers within given time frame;
- Arranged more than five hundred ninety eight domestic/international air tickets for officers of the Ministry.

### Public Grievance Cell

A Grievance Cell has been functioning in the Ministry to attend to the complaints of public regarding forestry, environmental matters etc. Joint Secretary (Admin.) has been nominated as Public Grievance Officer of the Ministry.

The particulars of the Public Grievance Officer of the Ministry are as under:

Joint Secretary (Admin.)  
Room No.440, (4<sup>th</sup> Floor),  
Paryavaran Bhawan, CGO Complex,  
Lodi Road, New Delhi – 110 003  
Tel.: 011-24361774.  
e-mail: [akg@nic.in](mailto:akg@nic.in)

The general public can meet the Public Grievance Officer every Wednesday from 10.00 AM to 1.00 PM. The main function of the Cell is to ensure timely redressal of public grievances by taking up the matter with the concerned authorities such as District Magistrates, Municipal Corporations, Pollution Control Boards, State Governments, etc. Most of the complaints related to:

- Unauthorised industries located in residential areas discharging harmful gases and hazardous effluents in the immediate neighbourhood.

- Environmental degradation due to mismanagement of civic amenities like location of waste dump, water logging etc.
- Poor maintenance of open areas and parks; and
- Commercial establishments operating illegally in the residential buildings causing nuisance to people living in the immediate vicinity.
- Non-settlement of payment of salary dues and retirement dues, benefits like pension etc. to staff.
- During the year, one hundred grievances were received from the general public and staff.

The Public Grievance cases are thus monitored regularly at specified time intervals in MoEF and the replies are sent to the complainants as early as possible. Once the final replies are sent, the petition is treated as closed and the same is indicated in the statements prepared in respect of Public Grievances.

The staff of various divisions/sections have been trained by holding one day video conferencing at Paryavaran Bhavan with the assistance of Directorate of Administrative Reform & Public Grievances (DARPG) officials to dispose off the complaints online through Centralised Public Grievance Redress And Monitoring System (CPGRAMS). To run the Public Grievances portal (PGRAMS), the IDs have been provided to the concerned Sections/Divisions in the Ministry for quick disposal of grievances/monitoring and issuing reminders online.

## Implementation of Official Language Policy

### Introduction

Sustained efforts were made to ensure proper compliance of the Official Language Policy of the Union, as envisaged in the Constitution of India, the Official Languages Act, the Official Languages Rules, the Annual Programme and orders issued from time to time.

All documents coming under the purview of Sec. 3(3) of the Official Languages Act were issued in Hindi and English bilingual form. The letters received in Hindi and representations/ appeals signed in Hindi were replied to in Hindi ensuring 100% compliance of the Rule 5 7(2) of the O.L. Rules.

### Progress of Activities undertaken

#### Official Language Implementation Committee

Meetings of Official Language Implementation Committee were organised with a view to review the status of implementation of Official Language Policy in the Divisions of the Ministry.

#### Hindi Workshop

Hindi workshops were organised for the officers and staff to carry out their day to day transaction in Hindi.

#### Incentive Schemes

Aimed at encouraging and motivating the employees to increase the use of Hindi, incentive schemes were implemented in the Ministry.

### Publication of Hindi Magazine "Paryavaran"

The special issue of "Paryavaran" magazine on medicinal plants was brought out.

### Inspections

High Power Committee of Parliament on Official Language inspected Botanical Survey of India, Allahabad, National Afforestation & Eco-Development Board, New Delhi and Wild life Crime Control Bureau, Mumbai. In addition to these inspections, twelve Attached/Subordinate Offices were also inspected by Joint Secretary/Director (OL) to review the position of implementing Official Language Policy of the Union.

### Hindi Fortnight

During the Hindi Fortnight various competitions were organized. The employees of the Ministry, NAEB and NRCD participated in these competitions. The winners were honoured with Cash Prizes and Commendation Certificates.

### Civil Construction Unit (CCU)

The Civil Construction Unit (CCU) was established in March, 1987. This Unit undertakes construction works for all the attached and subordinate offices of the Ministry such as BSI, ZSI, FSI, NMNH, IGNFA and autonomous bodies like IIFM, IPIRTI, WII, ICFRE and GBPIHED. The CCU has constructed a number of office buildings, laboratories, museums and residential accommodation at various places such as Almora, Dehradun, Bhopal, Delhi, Bengaluru, Jabalpur, Coimbatore and Hyderabad.



## Ministry of Environment & Forests

---

There are three divisions looking after construction activities throughout India. Two divisions are located at Delhi for works in Northern Region and the third division is located at Bengaluru for works under Southern Region.

Civil construction works of the Ministry are executed by CPWD where CCU does not have its own unit. CCU provides necessary inputs for planning and coordinates works being executed by CPWD. The management of budget also rests with CCU.

Some of the important works completed by CCU during the year 2009-2010 are:

– Five faculty quarters for IIFM at Bhopal.

The sanctioned cost of the project is Rs. 99.31 lakhs and the work has been completed in September, 2009.

– Five Type-IV quarters for WII at Dehradun. The sanctioned cost of the project is Rs.59.71 lakhs. It has been completed in June, 2009.

The construction work of museum and auditorium blocks for Rajiv Gandhi Regional Museum of Natural History at Sawai Madhopur is currently being executed by CCU. The sanctioned cost of the project is Rs.4100 lakhs. The museum & auditorium blocks shall be completed by December, 2010.

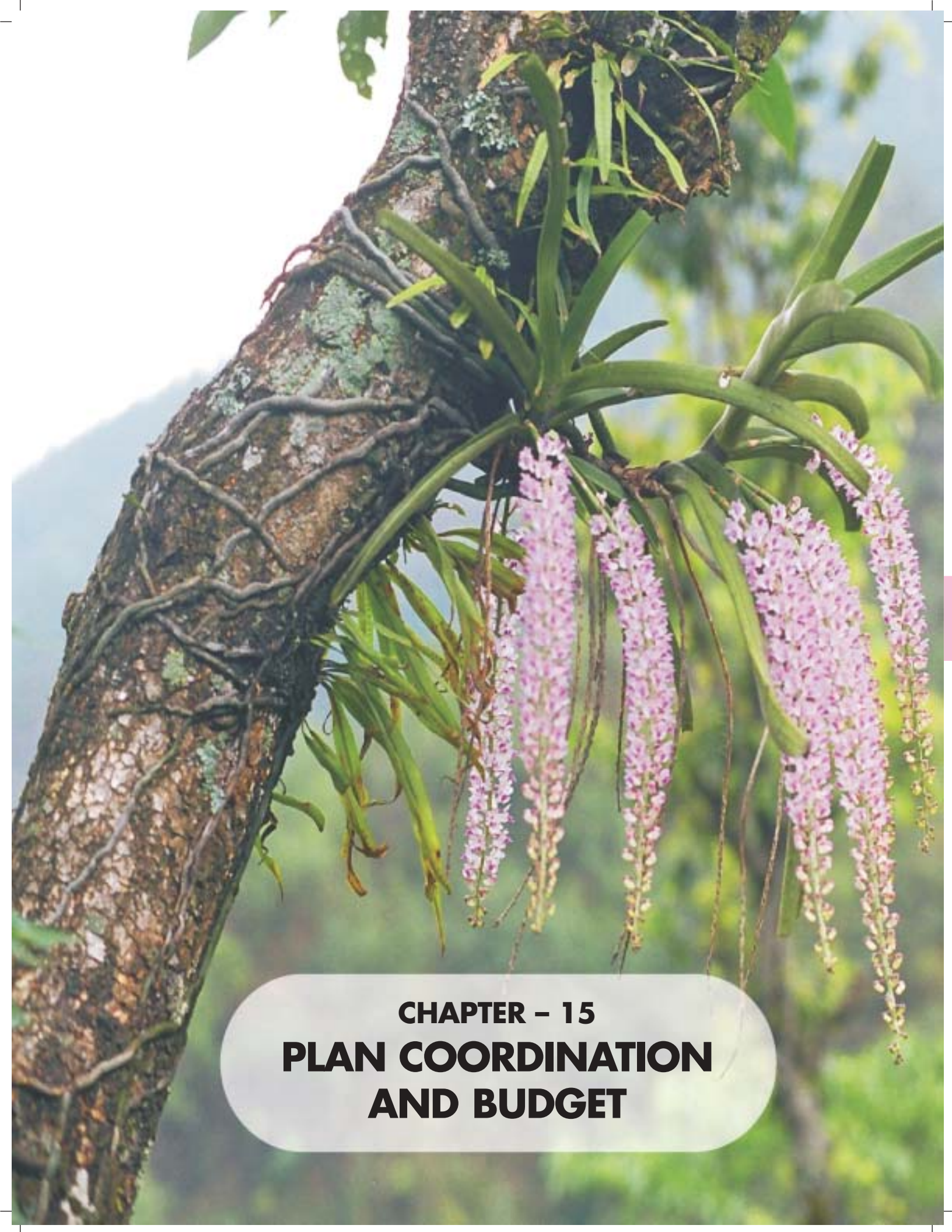

**CHAPTER - 15**  
**PLAN COORDINATION**  
**AND BUDGET**

## Ministry of Environment & Forests

### Introduction

The Plan Coordination Division is responsible for the coordination of all Plan schemes and programmes of the Ministry in close association with the Planning Commission. This involves preparation, monitoring and review of Five Year Plans, Annual Plans and the Annual Action Plans of the Ministry. The Division also looks after the monitoring of progress reports and reports under the 20-Point Programme (Points XV item No.52 & 53).

### XIth Five Year Plan (2007-2012)

Against an approved outlay of Rs.5945 crores, the total expenditure of the Ministry during the X<sup>th</sup> Five Year Plan (2002-07) amounted to Rs.5115 crores. For the XI<sup>th</sup> Five Year Plan, 2007-12, the Ministry has been provided with an outlay of Rs.10,000 crores. A Mid Term Appraisal of Ministry's XI<sup>th</sup> Five Year Plan was carried out by the Planning

Commission during the year. The Annual plan 2007-08, first year of the XI<sup>th</sup> Plan had an approved outlay of Rs.1351 crores against which the actual utilization amounted to Rs.1349.73 crores. The Annual Plan 2008-09, second year of the XI<sup>th</sup> Plan had an approved outlay of Rs.1500.00 crores against which the actual utilization amounted to Rs.1483.02 crores. For 2009-10, the approved outlay of the Ministry was Rs.1880.00 crores which has now been reduced to Rs 1650.00 crores in RE stage, against which an amount of Rs 1428.72 crores has been utilized till February, 2010. Sector-wise details are given in Table-32.

The progress of plan schemes are reviewed regularly in the Ministry and necessary corrective action is taken to ensure proper and meaningful deployment of resources with a view to build up the capacities of the State Governments in Forestry and Environment Sector, for the programmatic

**Table-32.** X<sup>th</sup> Plan Expenditure, XI<sup>th</sup> Plan Outlays / Expenditure – Ministry of Environment and Forests

(Rs. crore)

Sl. No.	Sector	X <sup>th</sup> Plan		XI <sup>th</sup> Plan	2007-2008		2008-2009		2009-2010		
		Outlay	Exp.	Outlay	Outlay	Exp.	Outlay	Exp.	Outlay	Outlay (RE)	Exp. (28.02.2010)
1	Environment	1200.00	918.83	1246.01	259.16	224.22	255.00	240.42	291.42	265.76	187.80
2	National River Conservation Directorate	1670.00	1543.69	2540.00	340.00	320.94	326.71	326.12	577.33	428.28	396.44
3	Forestry & Wildlife	1600.00	1283.55	2943.99	371.61	361.73	521.08	520.87	599.63	574.29	506.83
4	National Afforestation and Eco-development Board	1300.00	1293.40	3150.00	359.23	422.05	372.21	370.71	386.62	357.67	324.44
5	Animal Welfare	175.00	75.11	120.00	21.00	20.79	25.00	24.90	25.00	24.00	13.21
	<b>Total</b>	<b>5945.00</b>	<b>5114.58</b>	<b>10000.00</b>	<b>1351.00</b>	<b>1349.73</b>	<b>1500.00</b>	<b>1483.02</b>	<b>1880.00</b>	<b>1650.00</b>	<b>1428.72</b>

aspects and variegated Centrally Sponsored and Central Sector Scheme.

### Annual Plan 2010-11

An outlay of Rs.2200.00 crores has been allocated for the Annual Plan 2010-11

of the Ministry. The approved outlay comprises of Rs.1231.88 crores in Environment and Ecology Sector and Rs.968.12 crore in the Forestry and Wildlife Sector. Sector-wise details are given in Table-33.

Table-33. Plan Outlay for 2010-11

(Rs. crore)

Sl. No.	Sector	Outlay 2010-11
1	Environment	480.17
2	National River Conservation Directorate	751.71
3	Forestry & Wildlife	592.12
4	National Afforestation and Eco-development Board	352.00
5	Animal Welfare	24.00
	<b>Total</b>	<b>2200.00</b>

## ORGANISATIONAL STRUCTURE OF ( Divisions Under

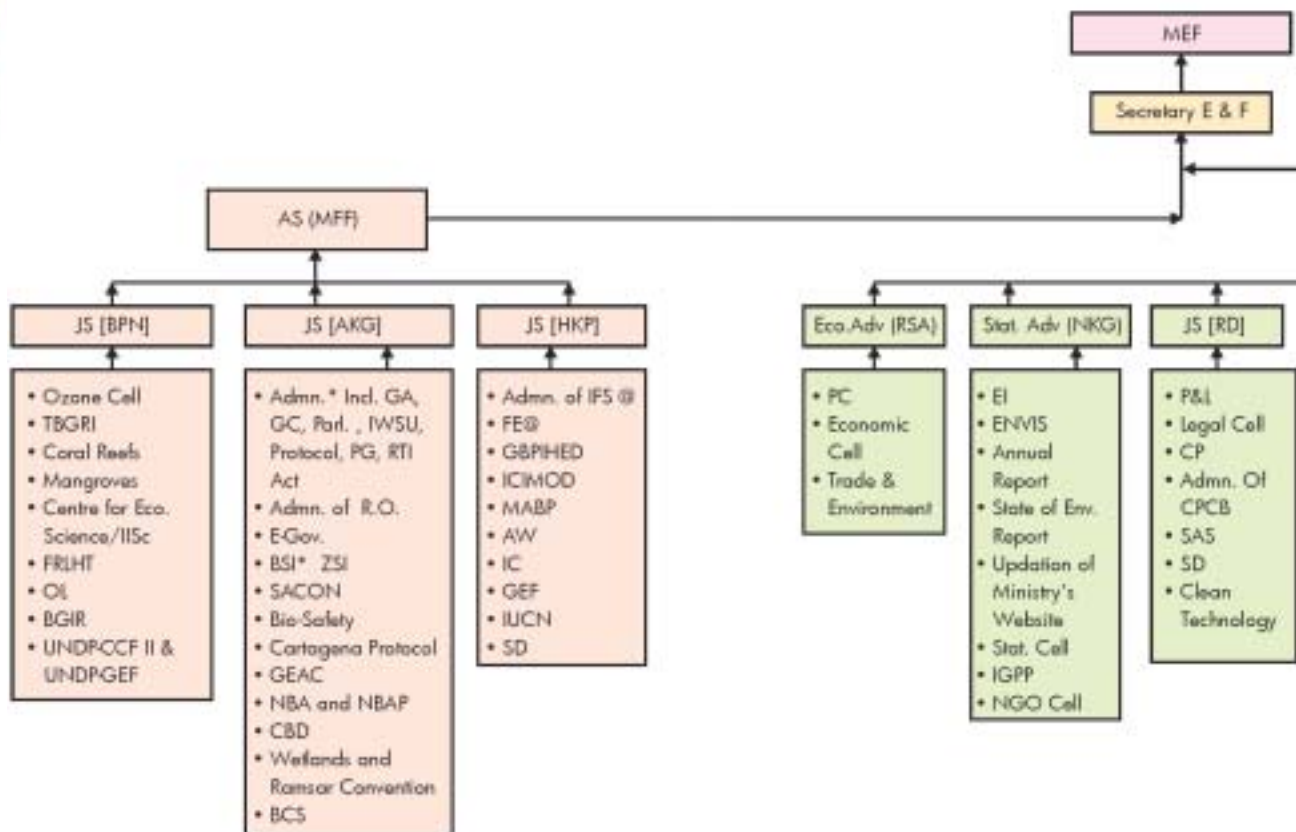

\* This work will directly be submitted to the Secretary (E&F)

\*\* Officers for this work will report to SS (RHK)

@ JS (HKP) will report to DGF&SS for this work

# Officers for this work will report to AS(JMM)

AW	: Animal Welfare	GPG	: Global Public Goods
BGIR	: Botanical Garden of the Indian Republic	GEAC	: Genetic Engineering Approval Committee
BG	: Botanic Garden	GC	: General Co-ordination
BSI	: Botanical Survey of India	GEF	: Global Environment Facility
CC	: Climate change	GA	: General Administration
CP	: Control of Pollution	IGPP	: Indira Gandhi Paryavaran Puraskar
CRZ	: Coastal Regulation Zone	IA	: Impact Assessment
CPCB	: Central Pollution Control Board	IC	: International Co-operation
CBP	: Capacity Building Project	FE	: Forest Establishment
CBD	: Convention on Biological Diversity	IWSU	: Internal Work Study Unit
EE	: Environment Education	MABP	: Man and Biosphere Programme
EIVR	: Entities of Incomparable Value Regulations	MD	: Male Declaration
ICIMOD	: International Centre for Integrated Mountain Development	NBAP	: National Biodiversity Action Plan
FRLHT	: Foundation for Revitalization of Local Health Traditions	NBA	: National Biodiversity Authority
GBPIHED	: G.B. Pant Himalayan Institute of Environment Development	NATCOM	: National Communication
		NRCD	: National River Conservation Scheme
		NILCP	: National Lake Conservation Plan
		PC	: Plan Co-ordination
		P&L	: Policy and Law



# MINISTRY OF ENVIRONMENT AND FORESTS (Environment Sector)

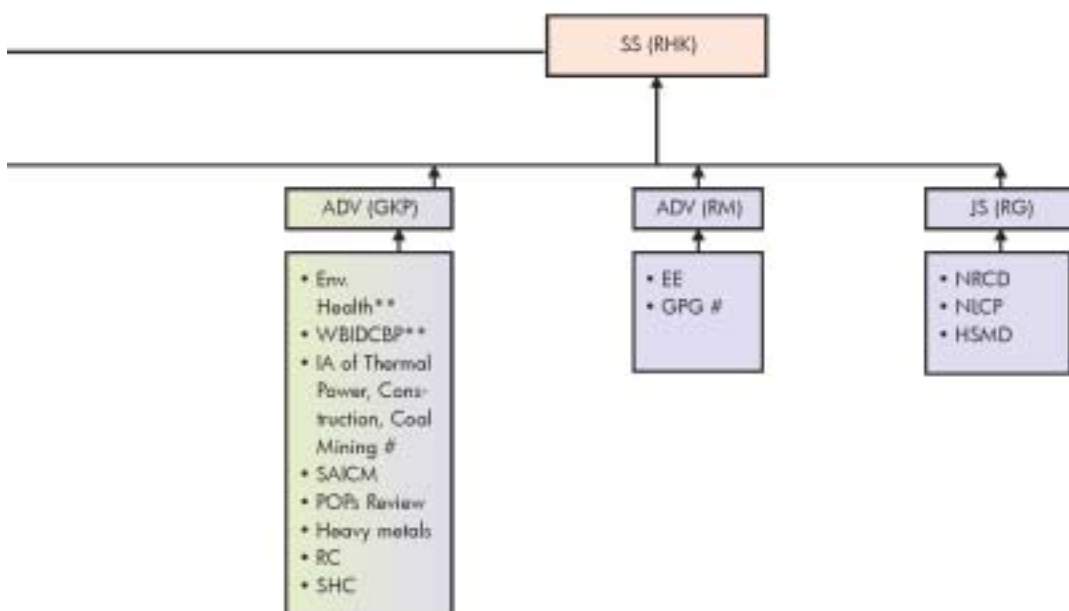

POPs	: Persistent Organic Pollutants
RE	: Research in Environment
SACON	: Salim Ali Centre for Ornithology & Natural History
SAICM	: Strategic Approach to International Chemicals Management
SAS	: Source Apportionment Studies
SD	: Sustainable Development
UNFCCC	: United Nations Framework Convention on Climate Change
UNCCD	: United Nations Convention to Combat Desertification
CDM	: Clean Development Mechanism
WBIDCBP	: World Bank Industrial Development Capacity Building Project
VIG	: Vigilance
HSMD	: Hazardous Waste Management Division
RC	: Rotterdam Convention.
OL	: Official Language
PG	: Public Grievances
ZSI	: Zoological Survey of India

SS (RHK): R.H. Khwaja, Spl. Secretary  
 AS (MFF): M. F. Farooqui, Addl. Secretary  
 JS (BPN): B.P. Nilaratna, Joint Secretary  
 JS (HKP): H.K. Panda, Joint Secretary  
 JS (AKG): A.K. Goyal, Joint Secretary  
 Eco. Adv (RSA): R.S. Ahlawat, Economic Adviser  
 Stat. Adv (NKG): Nilkanth Ghosh,  
 Statistical Adviser  
 JS (RD): Rajneesh Dube, Joint Secretary  
 Adv (GKP): G.K. Pandey, Adviser  
 Adv (RM): R. Mehta, Adviser  
 JS (RG): R. Gauba, Joint Secretary

ORGANISATIONAL STRUCTURE OF MINISTRY OF ENVIRONMENT AND FORESTS  
( Divisions Under Environment Sector)

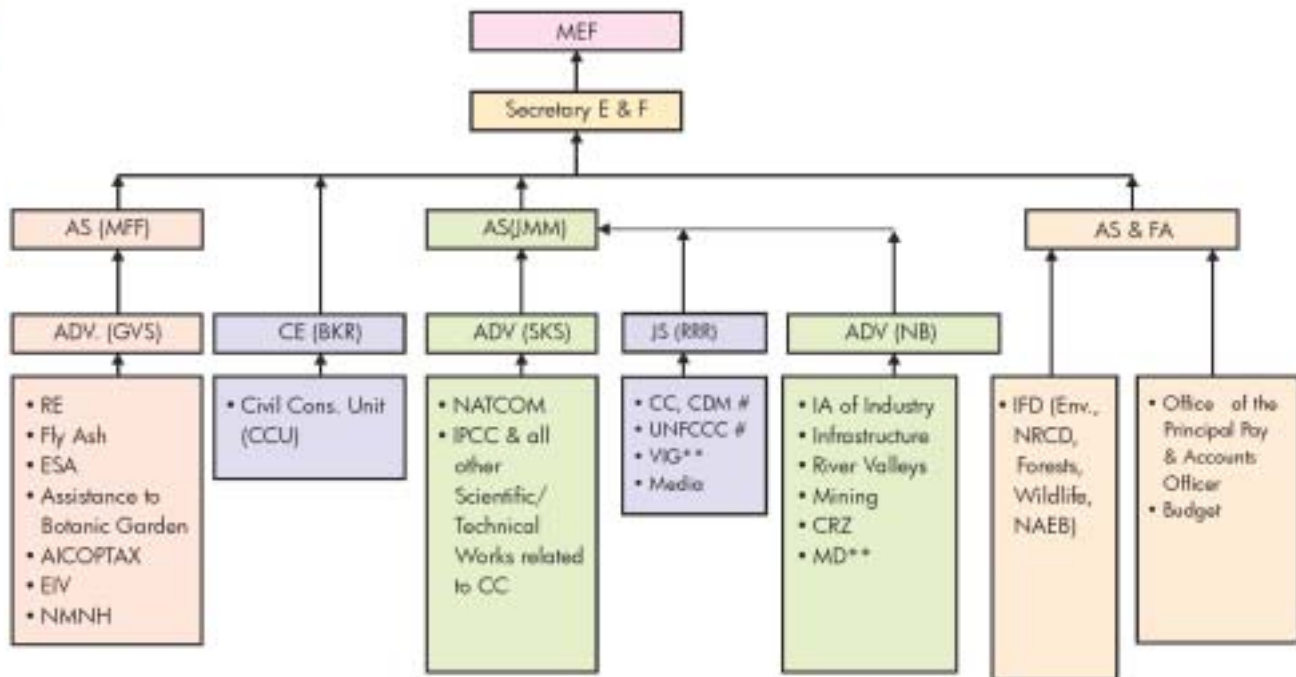

AS (MFF): M.F. Farooqui, Addl. Secretary  
 AS (JMM): J.M. Mauskar, Addl. Secretary  
 AS&FA: Additional Secretary and Financial Adviser  
 Adv (GVS): G.V. Subramaniam, Adviser  
 CE (BKR): B.K. Rokde, Chief Engineer  
 ADV (NB): Nalini Bhatt, Adviser  
 ADV (SKS): Subodh K. Sharma, Adviser  
 JS (RRR): R.R. Rashmi, Joint Secretary

\*\* Officers for this work will report to SS (RHK)

AICOPTAX : All India Coordinated Project on Building in Taxonomy  
 CRZ : Coastal Regulation Zone  
 CCU : Civil Construction Unit  
 EIV : Entities of Incomparable Value  
 ESA : Ecologically Sensitive Areas  
 HSMD : Hazardous Substances Management Division  
 IA : Impact Assessment  
 IFD : Integrated Finance Division

NRCD : National River Conservation Directorate  
 NDMA : National Disaster Management Authority  
 NMNH : National Museum of Natural History  
 NILCP : National Lake Conservation Plan  
 NAEB : National Afforestation and Eco-Development Board  
 PU : Public Liability Insurance  
 RE : Research in Environment  
 SWM : Solid Wastes Management

**ORGANISATIONAL STRUCTURE OF MINISTRY OF ENVIRONMENT AND FORESTS  
( Divisions Under Forestry and Wildlife Sector)**

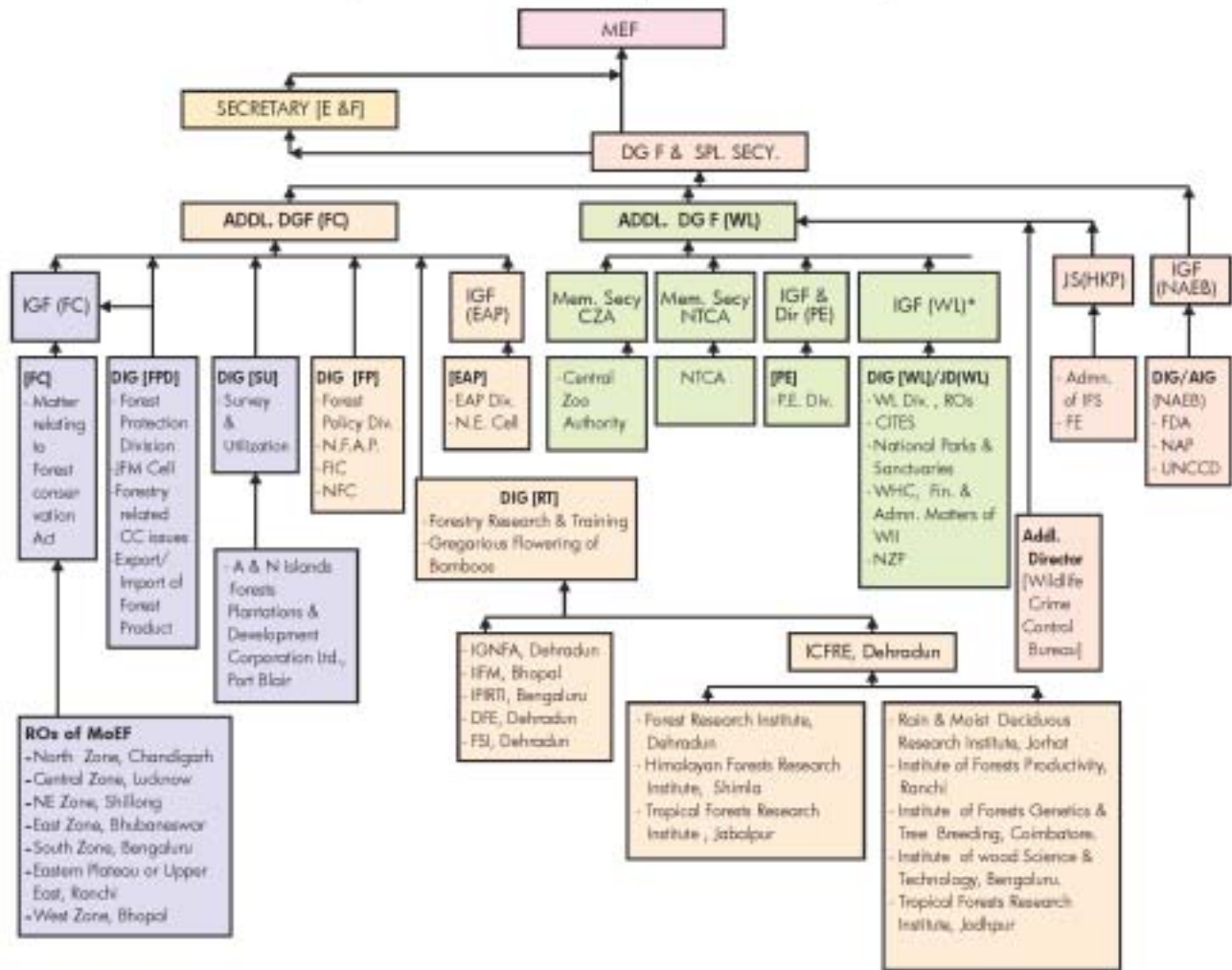

\* Vacant post of IGF(WL) is being looked after DIGF (WL)

- CITES : Convention on International Trade on Endangered Species
- DFE : Directorate of Forest Education
- EAP : Externally Aided Projects
- FC : Forest Conservation
- FPD : Forest Protection Division
- FP : Forest Policy
- FIC : Forest International Cooperation
- FSI : Forests Survey of India
- IPRTI : Indian Plywood Industries Research and Training Institute
- IIFM : Indian Institute of Forest Management
- IGNFA : Indira Gandhi National Forest Academy
- JFM : Joint Forest Management

- NFAP : National Forestry Action Programme
- PE : Project Elephant
- NZP : National Zoological Park, New Delhi
- NFC : National Forestry Commission
- NAEB : National Afforestation & Eco-development
- NTCA : National Tiger Conservation Authority
- ROs : Regional Offices
- RT : Research & Training
- SU : Survey & Utilization
- WHC : World Heritage Convention
- WL : Wildlife
- WII : Wildlife Institute of India

Regional Offices of the Ministry

S.No.	Name of the Organization/ Institute	Communication Linkage	Area
<b>Regional Offices</b>			
1.	Shri K.S Reddy, IFS Chief Conservator of Forest (C), Ministry of Environment and Forests, Regional Office (SZ), Kendriya Sadan, IV <sup>th</sup> FLOOR Floor, E&F Wings, 17 <sup>th</sup> Main Road, Koramangala II Block, Bangalore-560034 (Karnataka)	Ph. No. 080-25635901 Fax No. 080-25537184	Andhra Pradesh, Goa, Karnataka, Kerala, Tamil Nadu, Puducherry and Lakshadweep
2.	Shri J.K. Tewari , IFSC Chief Conservator of Forests (C), Ministry of Environment and Forests, Regional Office (EZ), A/3, Chandersekharapur, Bhubaneshwar-751023	Ph. No. 0674-2301213 Fax No. 0674-2302432	Orissa, Andaman & Nicobar, Island, Bihar, Jharkhand and West Bengal
3.	Shri A.K. Rana, IFS Chief Conservator of Forests (C), Ministry of Environment and Forests, Regional Office (WZ), E-5, Kendriya Paryavaran Bhawan, E-5 Arera Colony, Link Road-3, Ravishankar Nagar, Bhopal-462016	Ph. No. 0755-2466525 Fax No. 0755-2463102	Madhya Pradesh, Chhattisgarh, Maharashtra, Gujarat, Dadra & Nagar Haveli, Daman & Diu
4.	Shri B.N. Jha, IFS Chief Conservator of Forests (C), Ministry of Environment and Forests, Regional Office (NEZ), Uplands Road, Laitumkhrach, Shillong-793003	Ph. No. 0364-2227673 Fax No. 0364-2227047	Arunachal Pradesh, Assam, Manipur, Meghalaya, Tripura, Nagaland, Mizoram and Sikkim
5.	Shri Azam Zaidi, IFS Chief Conservator of Forests (C), Ministry of Environment and Forests, Regional Office (CZ), Kendriya Bhawan, 5 <sup>th</sup> Floor, Sector "H", Aliganj, Lucknow-226020	Ph. No. 0522-2326696 Fax No. 0522-2326696 0522-2323850	Uttar Pradesh, Uttarakhand and Rajasthan
6.	Shri S.K. Sehrawat, IFS, Conservator of Forests (C), Ministry of Environment and Forests, Regional Office (NZ), Bays No. 24-25, Sector 31 A, Dakshin Marg, Chandigarh-160030	Ph No. 0172-2638135 Fax No. 0172-2638061	Haryana, Himachal Pradesh, Punjab, J&K, Chandigarh and Delhi

**Regional Centres of National Afforestation and  
Eco-development Board (NAEB)**

<b>S.No.</b>	<b>Name &amp; Address of Regional Centre</b>	<b>State/UTs covered as per MOU</b>
1.	Regional Centre for NAEB Agriculture Finance Corporation Ltd. B-1/9, Community Centre, Janakpuri, New Delhi-110058	Haryana, Rajasthan, Uttar Pradesh, Uttarakhand and UT of Delhi
2.	Regional Centre for NAEB Agriculture Finance Corporation Ltd. Dhanraj Mahal, 1st Floor, CSM Marg, Mumbai-400001	Maharashtra, Gujarat, Goa and UTs of Daman & Diu, Dadar & Nagar Haveli
3.	Regional Centre for NAEB North Eastern Hill University, Shillong – 793 014	Arunachal Pradesh, Assam, Manipur, Meghalaya, Mizoram, Nagaland and Tripura
4.	Regional Centre for NAEB University of Agricultural Sciences, GKVK Campus, Bengaluru-560065	Andhra Pradesh, Karnataka, Kerala, Tamil Nadu and UTs of Puducherry and Lakshadweep
5.	Regional Centre for NAEB Indian Institute of Forest Management, Nehru Nagar, Post Box no. 357, Bhopal-462003	Chhattisgarh, Madhya Pradesh and Orissa
6.	Regional Centre for NAEB Dr. Y. S. Parmar University of Horticulture and Forestry, Nauni, Solan-173230	Himachal Pradesh, Jammu & Kashmir, Punjab and UT of Chandigarh
7.	Regional Centre for NAEB Jadavpur University, Kolkata-700032	Bihar, Jharkhand, Sikkim, West Bengal and UT of Andaman & Nicobar Islands

**Centres of Excellence / Autonomous / Associated Agencies etc.  
of Ministry of Environment and Forests**

Sl.No.	Centres of Excellence	Contact Details
1.	Centre for Environment Education (CEE), Nehru Foundation for Development, Thaltej Tekra, Ahmedabad – 380 054	Tel : 079-26858002-09, 26844745 Fax : 91-079-26858010 email: cee@ceeindia.org
2.	C.P.R Environmental Education Centre (CPREEC), 1 A, Eldams Road, Chennai – 600 018, Tamil Nadu	Tel : 044-24346526 Fax : 91-44-24320756 email: cpreec@vsnl.com
3.	Centre for Ecological Sciences (CES), Indian Institute of Science (IISc) Bengaluru – 560 012, Karnataka	Tel:080-23600382, 23600985 Fax:080-23602280, 23601428 email: chairman@ces.iisc.ernet.in
4.	Centre for Mining Environment (CME), Indian School of Mines, Dhanbad – 826 004, Jharkhand	Tel : 0326-2296624, 2202486 Fax : 0326-2296603, 2203042 email:cme@ismdhanbad.ac.in
5.	Salim Ali Centre for Ornithology and Natural History (SACON), Kalayampalayam, Coimbatore – 641 010	Tel: 0422-2657101-105, 2657086 Fax : 0422 2657088 email:centre@sacon.ernet.in
6.	Centre for Environmental Management of Degraded Ecosystems (CEMDE), School of Environmental Studies, University of Delhi, Delhi – 110 007	Telefax: 011-27666237 email : crb26@hotmail.com
7.	Madras School of Economics (MSE), Gandhi Mandampam Road, Chennai – 600 025	Telefax: 044-22352157, 22354847 Fax. : 044-22352155, 22352155 email: sankar_u75@hotmail.com mse@envis.nic.in
8.	Foundation for Revitalization of Local Health Traditions (FRLHT), 50 MSH Layout, 2 <sup>nd</sup> Stage, 3 <sup>rd</sup> Main, 2 <sup>nd</sup> Cross, Anand Nagar, Bengaluru – 560024	Tel.: 080-28565847, 8565890, 8565873 Fax.: 080-28565895, 8565873 email : s.ajith@frlht.org.in http://envis.frlht.org.in
9.	Tropical Botanic Garden and Research Institute(TBGRI), Pacha Palode, Thiruvananthapuram – 695562, Kerala	Tel : 0472 - 2869246 Fax : 0472-2869646 email: gmnair@satyam.net.in
10.	Centre for Animals and Environment, CARTMAN, Koramangala, 6 <sup>th</sup> Block, Bengaluru – 550 095, Karnataka	Tel.: 080-25530121, 25530304 email: indheritage@hotmail.com

**Autonomous Agencies**

**a) Environment Wing**

1	Central Pollution Control Board, Parivesh Bhawan CBD-cum-Office Complex, East Arjun Nagar, Delhi - 110 032	Tel : (011) 22308902, 22301932 Fax: (011) 22307233, 22304948 email: cpcb@alpha.nic.in
---	--	---

## Annual Report 2009-2010

- 2 Gobind Ballabh Pant Institute of Himalayan Environment and Development, Kosi - Katarmal, Almora - 263 643, Uttarakhand  
Tel : (05962) 241014  
Fax : (05962) 241150  
email: ao@gbpihed.nic.in
- b) Forest Wing**
- 1 Indian Institute of Forest Management, P.B. No. 357, Nehru Nagar, Bhopal - 462 003  
Tel : (0755) 775716  
Fax: (0755)772878  
email:ramprasad@iifm.bren.nic.in
- 2 Indian Plywood Industries Research and Training Institute, P.B. No. 2273, Tumkur Road, Bengaluru - 560 022  
Tel : (080) 8394231, 8394232  
Fax : 91-80-8396361  
email: ipirti@giasbg01.vsnl.net.in
- 3 Indian Council of Forestry Research and Education  
P.O. New Forests  
Dehradun - 248 006  
Tel : (0135)757021  
Fax: (0135)756865  
email: katwalrps@icfre.up.nic.in
- Research Institutes**
- 1 Forest Research Institute  
P.O. New Forests,  
Dehradun - 248 006  
Tel : (0135) 755277  
Fax: (0135) 756865  
email : rawatgs@icfre.up.nic.in
- 2 Institute of Forest Genetics and Tree Breeding,  
Forest College Campus  
P.B. No.1061, R.S. Puram H.P.O.  
Coimbatore - 641 002  
Tel : (0422) 431540, 435541  
Fax : (0422) 430549  
email: ifgcb@ sathyam.net.in
- 3 Institute of Wood Science and Technology,  
18th Cross, Malleswaram,  
Bengaluru - 560 003  
Tel : (080) 3341731  
Fax : (080) 3340529  
email:ksrao@iwst.res.in
- 4 Arid Forest Research Institute,  
New Pali Road,  
Jodhpur – 342 005, Rajasthan  
Tel: (0291)2722549  
Fax: (0291) 2722764  
email: director@afri.res.in  
<http://www.afri.res.in>
- 5 Tropical Forest Research Institute  
P.O. RFRC, Mandla Road,  
Jabalpur - 482 021 Rajasthan  
Tel : (0761) 322585  
Fax: (0761) 321759  
email: tfri@mantramail.com
- 6 Rain Forest Research Institute  
P.B. No. 136,  
Deovan Jorhat - 785 001, Assam  
Tel : 0376-322052, 322054  
Fax: (0376) 322052  
email : rainfor@sancharnet.in
- 7 Himalayan Forests Research Institute  
Shimla - 171 009,  
Himachal Pradesh  
Tel : (0177) 2626778  
Fax: (0177) 2626779  
email : hfri@hotdok.net.in
- 8 Institute of Forest Productivity  
Ranchi - 834 001, Madhya Pradesh  
Tel :(0651) 208234  
Fax: (0651) 208234  
email : ifp@bitSMART.dot.com



## Ministry of Environment & Forests

---

### Centres

- 1 Centre for Social Forestry & Eco-rehabilitation  
Allahabad - 211 002, Uttar Pradesh  
Tel : (0532) 609037  
Fax: (0532) 609037  
email : csfer@nde.vsnl.net.in
- 2 Centre for Forestry Research & Human Resource Development, Nagpur Road, Chhindwara-480001  
Tel: (07162) 43237
- 3 Forest Research Centre  
F-105, 1st Floor, Sri Ranga Towers  
Sardar Nagar, Safilguda,  
Hyderabad-500004  
email : tfri@mantramail.com
- 4 Advanced Centre for Bamboo and Rattan  
P.B. No. 136, Deovan,  
Jorhat-785001, Assam  
email : ksrao@iwst.res.in

### c) Wildlife Wing

- 1 Wildlife Institute of India,  
P.B. No. 18, Chandrabani,  
Dehradun - 248 001  
Tel : (0135) 640112-115  
Fax:(0135) 640117  
email: wii@gov.in
- 2 Central Zoo Authority  
Bikaner House, Annexe VI  
Shahjahan Road , New Delhi - 110011  
Tel : 011-23381585  
Fax : 011-23386012  
email : cza@ndf.vsnl.net.in  
<http://envfor.nic.in/cza>

### Subordinate Offices

#### a)Environment Wing

- 1 Botanical Survey of India  
CGO Complex, 3rd MSO Building,  
DF Block, Sector 1, Salt Lake City,  
Kolkata – 700 064  
Tel : 033-23346040/4963  
Fax : 033-23215631  
email : bsi\_headquarter@rediffmail.com
- 2 Zoological Survey of India  
M-Block, New Alipur,  
Kolkata - 700 053  
Tel : (033) 24006893, 24003383  
Fax : (033) 24006893  
email: enviszsi@cal.vsnl.net.in
- 3 National Museum of Natural History,  
FICCI Building, Barakhamba Road,  
New Delhi - 110 001  
Tel : (011) 3314932  
Fax : (011) 3314932  
<http://www.nmnh.org>

#### Regional Centres of ZSI

1. The Officer In Charge,  
Zoological Survey of India,  
Eastern Regional Station,  
Fruit Garden, Risha Colony,  
Shillong-793003, Meghalaya.  
Tel.:0364-223638, 226495  
Fax:0364-226495



## Annual Report 2009-2010

2. The Officer In Charge,  
Zoological Survey of India,  
Western Regional Station,  
Vidya Nagar, Sector 29,  
PB No. 3053, PCNTDA Post,  
Near Akurdi Rly, Station,  
Pune-411044, Maharashtra. Tel.:020-7652564, 7651927,  
5880054(R)  
Fax:020-7652564
3. The Officer In Charge,  
Zoological Survey of India,  
Northern Regional Station,  
218 Kaulagarh Road,  
P.O : IPE, Dehradun-248195, U. P. Tel.:0135-758349, 758362(O/C),  
54939(O),758362  
Fax:0135- 671826
4. The Officer In Charge,  
Zoological Survey of India,  
Central Regional Station,  
424, New Adarsh Colony,  
Kamala Nehru Nagar,  
Jabalpur-482002, Madya Pradesh. Tel.:0761-315592
5. The Officer In Charge,  
Zoological Survey of India,  
Desert Regional Station,  
Pali Road, Jhalamand,  
Jodhpur-342001, Rajasthan. Tel.:0291-750408
6. The Officer In Charge,  
Zoological Survey of India,  
Southern Regional Station,  
100, Santhome High Road,  
Chennai-600028, Tamil Nadu. Tel. : 4942898, 4943255  
Fax. : 044-4942898
7. The Officer In Charge,  
Zoological Survey of India,  
Arunachal Pradesh Field Station,m,  
Senkhi Valley, Post Box No. 112,  
Itanagar-791113, Arunachal Pradesh. Tel. : 0360-203652,  
2203653(R)  
Fax : 0360-20652
8. The Officer In Charge,  
Zoological Survey of India,  
Gangetic Plains Regional Station,  
Handloom Bhawan(4thFL.),  
Rajendra Nagar, Patna-800016, Bihar. Tel. : 670686, 350332
9. The Officer In Charge,  
Zoological Survey of India,  
Marine Aquarium Cum Research Centre,  
Digha, District:  
Midnapore-741428, West Bengal. Tel. : 66310, 66311,  
66312, 66463(R)



## Ministry of Environment & Forests

---

10. The Officer In Charge,  
Zoological Survey of India,  
High Altitude Zoology Field Station,  
Opposite Saproon Gurudwar,  
Saproon, Solan-173211  
Tel. : 01792-20413, 24483,  
09816024105  
(Mobile) 23174(R)  
Fax : 01792-21060
11. The Officer In Charge,  
Zoological Survey of India,  
Marine Biological Station,  
100, Santhome High Road,  
Chennai-600028, Tamil Nadu.  
Tel. : 4942680, 4943191,  
4450853(R)  
Fax : 044-4942680
12. The Officer In Charge,  
Zoological Survey of India,  
Andaman and Nicobar Reg. Station,  
Port Blair-7441002, Andaman.  
Tel. : 03192-3314830115(R),  
33157(R),  
Fax : 03192-30115
13. The Officer In Charge,  
Zoological Survey of India,  
Fresh Water Biological Station,  
1-1-300/B, Ashok Nagar,  
Hyderabad-500020, Andhra Pradesh.  
Tel. : 040-7603514,  
4800620(R)  
Fax : 040-7634662
14. The Officer In Charge,  
Zoological Survey of India,  
Sunderbans Field Reg. Station,  
Canning-743329,  
Dist: 24 Parganas(S), West Bengal.  
Tel. : 9118-5521  
(Local Call From Calcutta),  
033-4550651  
Fax : 03128-55211
15. The Officer In Charge,  
Zoological Survey of India,  
Estuarine Biological Station,  
Hill Patna, Behrampur-760005, Orissa.  
Tel. : 0680-206894,  
202676(R)  
Fax : 0680-200637
16. The Officer In Charge,  
Zoological Survey of India,  
Western Ghats, Field Res. Stn.,  
Kamala Buildings, 1st Floor,  
Annie Hall Road,  
Kozikode-673002, Kerala.  
Tel. : 0495-357884(R)  
Telefax : 0495-701928

### Regional Centres of BSI

1. Botanical Survey of India  
India, Central Circle, 10, Chatham Lines,  
Allahabad- 211002, Uttar Pradesh.  
TeleFax: 0532 2250179  
Phone : 0532 2441192  
Fax: 0135-2757951
2. Botanical Survey of India  
Northern Circle, 192 , Kaulgarh Road, Dehra  
Dun- 248195 , Uttarakhand  
Phone: 0135-2753433  
Fax: 0291 2741736

## Annual Report 2009-2010

3. Botanical Survey of India  
775/80, Subhas Nagar,  
Khema Ka Kuan, P.O Nandavan,  
Jodhpur- 342008, Rajasthan  
Phone: 0291 2747163
4. Botanical Survey of India  
Western Circle, 7,  
Koregaon Road, Pune- 411001,  
Maharashtra  
Phone : 26122125  
Fax (020 26124139  
Fax: 0422 2432835
5. Botanical Survey of India  
Southern Circle, T.N.A.U. Campurs,  
Lawlay Road, P.O. Coimbatore-641003,  
Tamil Nadu.  
Phone: 2432788,2432487  
Fax: (0364 2224119
6. Botanical Survey of India  
Eastern Circle , Woodlands, Laithmukrta,  
Shillong – 793003  
Phone : 0364 2223971, 2223618  
Fax: 0360 2211713
7. Botanical Survey of India  
Arunachal Field Station, Sankie View,  
Itanagar – 791111, Arunachal Pradesh  
Phone: 0360 2212405  
Fax: 03192 230120
8. Botanical Survey of India  
Andaman & Nicobar Circle,  
P.O. No. 692, Haddo, Port Blair-744102.  
Phone: 03192 233224  
Fax: 03592 204717
9. Botanical Survey of India  
Sikkim Himalayan Circle,  
Below Rajbhawan Campus,  
P.O. Rajbhawan,  
Gangtok – 737103, Sikkim  
Phone 202789
10. Botanical Survey of India  
Decan Circle,  
Zoological Survey of India Campus,  
Plot No. 366/1, Attapur, Hyderguda post,  
Hyderabad - 500 048  
Tel:(0422) 2435987,  
M.: 098668849872

### **b) Forest Wing**

1. Forest Survey of India,  
Kaulagarh Road, P.O. IPE,  
Dehradun-248195  
Tel:(0135) 756139, 755037  
Fax:(0135) 759104  
email: fsidir@nde.vsnl.net.in
2. Indira Gandhi National Forest Academy  
P.O. New Forests,  
Dehradun - 248 006  
Tel : (0135)2754647  
Fax: (0135) 2757314  
email: ignfa@ignfa.up.nic.in
3. Directorate of Forest Education  
P.O. New Forest, Dehradun - 248 006, UP  
Tel: (0135) 757326  
Fax : (0135) 757326

**Regional Offices of Forest Survey of India**

1. Regional Director (Central Zone)  
Forest Survey of India, Central Zone  
C.G.O. Complex, Block 'A',  
Seminary Hills, Nagpur-440006  
Tel : 0172-2510194 (O),  
2511309 (R)  
email: tejinder\_84@rediffmail.com
2. Regional Director (Eastern Zone)  
Forest Survey of India, 97/1B,  
Hazra Road  
(2nd Floor), Kolkata – 700026  
Tel : 033-24752812 (O)  
24483377 (R), 9830054124 (M)  
Fax : 033-24752812  
email: regdirez@hotmail.com
3. Regional Director (SZ)  
Forest Survey of India, 8th Floor, B-Wing,  
Kendriya Sadan, Koramangala,  
Bengaluru - 34  
Tel : 080-25520136  
Fax : 080-25520136  
email: fsisz@blr.vsnl.net.in
4. Regional Director (North Zone)  
Forest Survey of India, North Zone,  
Himlok Parisar, "Shivalik Khand", Batsley  
Longwood, Shimla - 171001,  
Himachal Pradesh  
Tel : 0177-2658285  
Fax : 0177-2655572

**c) Wildlife Wing**

1. Director,  
National Zoological Park,  
Mathura Road, New Delhi - 110 003  
Tel : (011) 4619825  
Fax : (011) 4602408

**Regional Offices**

1. Wildlife Preservation  
Western Region, 11 Air Cargo Complex  
Sahar, Mumbai - 400 099  
Tel : (022) 8230666  
Fax: (022)8230666
2. Wildlife Preservation  
Eastern Region, Nizam Palace,  
6th Floor, M.S. Building,  
234/4, A.J.C. Bose Road,  
Kolkata - 700 020  
Tel : (033) 2478698  
Fax : (033) 2478698
3. Wildlife Preservation  
Northern Region, Bikaner House,  
ShahjahanRoad, New Delhi - 110 011  
Tel : (011) 3384456  
Fax: (011) 3384456
4. Wildlife Preservation  
Southern Region, C-2/A, Rajaji Bhawan,  
Basant Nagar, C.G.O. Complex,  
Chennai - 600 090  
Tel : (044) 4916747  
Fax: (044)4916747

**Public Sector Undertaking**

- 1 Andaman & Nicobar Islands Forests and  
Plantation Development Corporation Ltd.  
Van Vikas Bhawan, Port Blair,  
Andaman & Nicobar Islands.  
Tel : (03192) 20261, 20752  
Fax : (03192) 21254

**LIST OF PROJECTS SANCTIONED DURING 2009-2010**

**Environment Research Programme (ERP)**

<b>Sl.No.</b>	<b>Title of the Project</b>	<b>Name of Principal Investigator &amp; Institute</b>
1.	Development of Environmentally benign process technology for extraction of Natural Dye of North-Eastern Region	Dr. P.G. Rao, North-East Institute of Science & Technology, Jorhat-785006, Assam
2.	Phytoremediation of Saline soils by a Novel Arbuscular Mycorrhiza- like Fungus for value addition and growth promotion of selected medicinal plants.	Dr. Amit C. Kharkwal, Amity Institute of Microbial Technology, Amity University Uttar Pradesh, Sector-125, Expressway, Noida-201301
3.	Phyto-remediation using mangrove species for sustainable water quality in Uppanar Estuary of Cuddalore district, TamilNadu –A novel approach.	Dr. P. Mullai, Department of Technology, Annamalai University, Annamalai Nagar-608002, Tamil Nadu
4.	Incubation Studies on the effect of soil and environmental parameters on formation and emission of nitrous oxide.	Dr. Gautam Roy Chaudhury, Institute of Minerals and Materials Technology, Bhubaneswar-751013, Orissa
5.	Study of pesticide pollution in Karnataka through honeybees and their products as bioindicators	Dr. V. Sivaram, Department of Botany, Bangalore University, Bangalore-560056, Karnataka
6.	Mono-and bi-metallic nanoparticles adsorbed on solid support : A cost effective and efficient way for treatment of industrial effluents and contaminated surface water	Dr. Praveen Kumar Tandon, Department of Chemistry, University of Allahabad, Allahabad-211002, Uttar Pradesh (U.P)
7.	Treatment of petroleum refinery waste water in sequencing batch reactor	Dr. Indra Deo Mall, Department of Chemical Engineering, IIT Roorkee, Roorkee-247667, Uttarakhand
8.	Development of new pesticide delivery devices for remediation of Environmental pollution.	Dr. D.K. Sharma, Department of Chemistry, H.P. University, Summer Hill, Shimla-171005. Himachal Pradesh (H.P)
9.	Impact assessment of continuous fertilization on heavy metals and microbial diversity in soils under long term fertilizer experiment.	Dr. Tapan Adhikari, Indian Institute of Soil Science, Nabibagh, Berasia Road, Bhopal-462038
10.	Development of technology for biodegradable nursery pots	Dr. S P Agrawal, Director & Head, Organic Building, Material Division, Central building research institute, Roorkee-247667



## Ministry of Environment & Forests

Sl.No.	Title of the Project	Name of Principal Investigator & Institute
11.	Utilization of ants as bio-indicators to monitor environmental pollution in spoils of coal mines and red mud dumps of Aluminum smelters.	Dr.(Mrs.) Neelkamal Rastogi, Centre of Advanced Study, Deptt. of Zoology, Banaras Hindu University, Varanasi-221005.
12.	Development of molecular markers for the identification of biological forms of <i>Anopheles stephensi</i> prevalent in arid areas of Rajasthan.	Dr. Karam V. Singh, Desert Medicine Research Centre, Indian Council of Medical Science, New Pali Road, Jodhpur-342005, Rajasthan
13.	Environmental and socio-economic externalities of land Degradation the Nilgris Mountain of Tamil Nadu	Dr. C. Sekar, Agricultural Engineering College and Research Institute, Post Harvest Technology Centre, Tamil Nadu Agricultural University, Coimbatore-641003
14.	Effects of pollutants on the Biodiversity river Jhelum with special emphasis on cold water fisheries	Dr. Mohammad Farooq Mir, Post Graduate Department of Environment & Science / Hydrology, Faculty of Science, S.P. College, Srinagar-190001 (J&K)
15.	Environmental concentration of microbial polyester as potential bioindicators of pollution and their degradation studies.	Dr. R.M. Murugappan, Department of Zoology, Unit of Industrial Microbiology Thiagarajar College, Madurai-625 009, Tamil Nadu.
16.	Assessment of Exposure to Toluene disocyanate (TDI) among polyurethane from industry workers	Dr. S. Raghavan, National Institute of Occupational Health (NIOH), Post Box No. 2031, Meghaninagar, Ahmedabad-380016, Gujarat
17.	Persistent organic pollutants(POPs) in sediments and food web of tropical mangrove ecosystem at Pichavaram, South India	Dr. T. Jeyakumar, Chemistry Section (FEAT), Annamalai University, Annamalai Nagar -608002 Tamil Nadu
18.	Impact of Diesel Oil Pollution on Freshwater Aquaculture and its Possible Bioremediation by Microorganisms	Dr. Apurba Ratan Ghosh, Department of Environmental Science, The University of Burdwan, Burdwan – 713104 (W.B.)
19.	Bryophytes-tool for National Multi -Elemental atmospheric survey of 100 years	Dr. Dinesh K. Saxena, Department of Botany, P.G. D. Environment Management Bareilly, Bareilly College Bareilly-243005, Uttar Pradesh (U.P)
20.	Cellular/molecular mechanisms involved for arsenic detoxification and tolerance in rice and Indian mustard varieties	Dr. Meetu Gupta, Deptt. of Biosciences, Jamia Millia Islamia, New Delhi-110025

## Annual Report 2009-2010

Sl.No.	Title of the Project	Name of Principal Investigator & Institute
21.	Assessment of anthropogenic activities on soil / water and certain medicinal plants species in and around Bharalu river in Guwahati city	Dr. Jibon Kotoky, Institute of Advanced Study in Science & Technology (IASST), Paschim Boragaon, Vigyan Garchuk, Guwahati-781035, Assam
22.	Development of new environment friendly adsorption media and its value added application for removal of hazardous anions from water.	Dr. Rajkishore Patel, Department of Chemistry, National Institute of Technology, Rourkela-769008, Orissa
23.	Modeling of environmental emission and design and development of fuzzy controlled Fume extraction system for electric discharge machining process.	Dr. S.P. Sivapirakasam, Department of Mechanical Engineering, National Institute of Technology, Tiruchirappalli-620015, Tamil Nadu
24.	Study on macro-fungal diversity in forest litter and screening their ligninolytic properties to explore the feasibility of using litter-decomposing fungi as bioremediants.	Prof. Sujata Chaudhuri, Deptt. of Botany, University of Kalyani, Kalyani-741235, Dt. Nadia, West Bengal
25.	Occurrence and impact of endocrine disrupting substances in the chosen fin and shell fishes of south-east coast of India	Dr. P. Subramanian, Department of Animal Sciences, Bharathidasan University, Tiruchirappalli-620024, Tamil Nadu
26.	Abatement of F2 using fluidized Bed	Dr. (Mrs.) Abanti Sahoo, Department of Chemical Engineering, NIT, Rourkela-769008, Orissa
27.	Impact of stone mining on water quality of Tlawng river in Mizoram: Strategy for management of river water through eco-restoration of abandoned mine areas.	Dr. B.P. Mishra, Department of Forest Ecology Biodiversity & Environmental Sciences, Mizoram University, Aizawl-796 009. Manipur
28.	Metallothionein Gene, a molecular biomarker for Heavy Metal Pollution and management	Dr. Balu T. Kuzhivelil, Department of Zoology, Christ College, Irinjalakuda, Kerala-680125.

### Ecosystem Research Scheme (ERS)

Sl.No.	Title of the Project	Name of Principal Investigator & Institute
1.	Algal Flora from different habitats of Central Assam and Conservation of Collected Strains	Dr. Farishta Yasmin, Senior Lectur in Botany Deptt. of Botany, Nowgong College P.o. Nagaon, Assam-782 001.
2.	An analytical study of JFM program for evolving strategy for its revival in Madhya Pradesh and Chhattisgarh State	Dr. P. Bhattacharya, Faculty, Technical Forestry, Indian Institute of Forest Management, P.B. No. 357, Bhopal-462 003.

## Ministry of Environment & Forests

Sl.No.	Title of the Project	Name of Principal Investigator & Institute
3.	Diversity of Endophytic Fungi in Selected Medicinal Plants of Melghat Forest	Dr. M.K. Rai, Professor & Head Deptt. of Biotechnology, Sant Gadge Baba Amravati University Amravati-444602, Maharashtra
4.	Assessment of Bryo-diversity in Uttarakhan, Western Himalaya	Dr. Geeta Asthana, Reader Deptt. Of Botany, University of Lucknow, Uttar Pradesh

### Eastern and Western Ghats Research Programme (E&WGRP)

Sl.No.	Title of the Project	Name of Principal Investigator & Institute
1.	Dung specificity, Guild structure, seasonality and Species composition of Dung beetles ( <i>Coleoptera: scarabaeinae</i> ) associated with the dung droppings of major mammals (Elephant, Gaur, Wild Boar, Deer and Macaque) and composition of Arboreal dung beetles in the wet and dry forests of the Western Ghats	Shri Sabu K. Thomas Post Graduate & Research Deptt. of Zoology, St. Joseph's College, Devagiri, Calicut-673 008, Kerala.
2.	Biodiversity of Predatory Hemipteran Insects in Southern Western Ghats and their utility in Biological Control	Dr. K. Sahayaraj Deptt. of Advanced Zoology and Biotechnology, St. Xavier's college (Autonomous), Palayamkottai-627002, Tamil Nadu.

### Policy Research

1.	Distribution of benefits and Costs among stakeholders of a Protected Area : An empirical study of Great Himalayan National Park (GHNP) in Kullu (HP)	Dr. R S Prasher Regional Horticultural Research Station, Jachh (Nurpur), Dist. Kangra-176201 (H. P.)
----	--	--

### National Natural Resource Management System (NNRMS)

Sl.No.	Title of the Project	Name of Principal Investigator & Institute
1.	Forests in Carbon Sequestration: Estimating Carbon Sequestration Potential using Remote Sensing and GIS	Dr. P.V. Karunakaran, Director, Natural Resource Management, Centre for Environment and Development, Thozhuvancode, Vattiyookavu P.O., Thiruvananthapuram-695013, Kerala
2.	To develop a protected area. Information management system in Namdapha National Park Mauling National Park Mehao Sanctuary and D'Ering Memorial Wildlife Sanctuary – Arunachal Pradesh using Remote Sensing of GIS Technology	Dr. G. Areendran World Wide Fund for Nature – India, Lodhi Road, New Delhi-110003



## Annual Report 2009-2010

Sl.No. Title of the Project	Name of Principal Investigator & Institute
3. Mapping of Non-Timber Forest Produce using Remote Sensing and GIS	Dr. V.K. Srivastava, RS&GIS Application Area, National Remote Sensing Agency (Department of Space), Balanagar, Hyderabad-500037, Andhra Pradesh
4. Monitoring of Arsenic in Ground Water of Ballia District, Uttar Pradesh Using Remote Sensing and GIS Techniques.	Dr. Imran Ali, Department of Chemistry, Jamia Millia Islamia, New Delhi-110025
5. Use of Remote Sensing and GIS for urban solid waste disposal (Identification of Dumping site and optimal transportation Route Modeling)	Prof. Anjana Vyas, Centre for Research and Development Unit (CRDU), CEPT, K.I. Campus, Navrangpura, Ahmedabad-380009, Gujarat
6. Landslide hazard zonation of Kalingpung subdivision of West Bengal and creation of a portal to upload Landslide hazard map and all other maps created using open GIS	Dr. P.K. Paul, Department of Mining Engineering, Bengal Engineering and Science University, Shibpur, Howrah-711103, West Bengal
7. Forest Encroachment in Karnataka – A two decadal analysis using RS and GIS	Dr. R.K. Somashekhar, Department of Environmental Science, Bangalore University, Bangalore-560056, Karnataka
8. Development of Forest Fire Management System in Shimla Forest Division in Himachal Pradesh (India) Using Geospatial Information System Impact of Glacier Recession on the Vegetative	Dr. Laxmi Kant Sharma Department of Remote Sensing Birla Institute of Technology Mesra-835215, Ranchi

### Biosphere Reserve Scheme

Sl.No. Title of the Project	Name of Organization
1. Cover of the Valley of Flowers, Uttarakhand Himalaya	Dr. Laxmi Kant Sharma, Department of Remote Sensing, Birla Institute of Technology, Mesra-835215, Ranchi

### National Wetland Conservation Programme (NWCP)

Sl.No. Title of the Project	Name of Organization
1. Geo-Environmental analysis of Vellayani Lake, Kerala southwest India University of Kerala	Dr. V.Sobha University of Kerala
2. Nematode faunal diversity and community structure: indicators of the environmental conditions at at Keetham Lake Agra"	Prof. (Dr.) Qudsia Tahseen, Reader in Zoology, Aligarh Muslim University
3. Environmental Resources Research Centre, Ashtamudi Lake, Kerala	Dr.M.P.Nayar, Kozhicode, Kerala

**National River Conservation Plan**

S. No.	Name of the Project/ Scheme	Name of the Town/ City
<b>Haryana</b>		
1.	Common Reforms Implementation Programme	Faridabad (YAP-II)
<b>Maharashtra</b>		
2.	Sewage Treatment Plant (76 mld)	Kolhapur, (ORCP)
<b>Madhya Pradesh</b>		
3.	Low Cost Sanitation	Chitrakut (ORCP)
4.	Interception & Diversion	Chitrakut (ORCP)
5.	Land Acquisition	Chitrakut (ORCP)
6.	Public Awareness & Participation	Chitrakut (ORCP)
7.	River Front Development	Chitrakut (ORCP)
8.	Sewage Treatment Plant (4.7 mld)	Chitrakut (ORCP)
9.	Improved Wood Crematoria	Chitrakut (ORCP)
<b>Rajasthan</b>		
10.	Sewage Treatment Plant (30 & 6 mld) and I & D	KOTA (ORCP)
<b>Sikkim</b>		
11.	STP and Rehabilitation of Sewer Main(Bye Pass)	Gangtok (ORCP)
<b>Tamil Nadu</b>		
12.	Interception & Diversion	Thanjavur (ORCP)
<b>Uttarakhand</b>		
13.	Interception & Diversion	Deo Prayag (S/C Towns)
14.	Sewage Treatment Plant (1.4 mld)	Deo Prayag (S/C Towns)
15.	Interception & Diversion	Karan Prayag (S/C Towns)
16.	Interception & Diversion	Rudra Prayag (S/C Towns)
17.	Sewage Treatment Plant (3.0 mld)	Rudra Prayag (S/C Towns)
<b>West Bengal</b>		
18.	River Front Development	Barrackpore (GAP-II), (Main Stem)
19.	Seven Ghat (bank of Hooghly River)	Barrackpore (GAP-II) , (Main Stem)
20.	River Front Development	Biadyabati (GAP-II) , (Main Stem)
21.	Electric Crematoria	Naihati (S/C Towns)
22.	Lifting Station for Pollution Abatement	Tolly's Nallah(GAP-II) , (Main Stem)
<b>YAP</b>	→	Yamuna Action Plan
<b>ORCP</b>	→	Other River Conservation Plan
<b>S/C Towns</b>	→	Supreme Court Order Towns
<b>GAP-II</b>	→	Ganga Action Plan Phase-II (Main Stem)

**National Lake Conservation Plan**

S. No.	Lake	State	Sanctioned cost(in Rs. crore)
1.	Three lakes of Bangalore namely Vengaiakere, Nagavara and Jarganahalli	Karnataka	11.48
2.	Bellandur lake, Bangalore	-do-	5.54
3.	Kotekere lake, Belgaum	-do-	5.64
4.	Bhishma lake, Gadag	-do-	2.50
5.	Lal Bagh, Bangalore	-do-	1.66
6.	Channapatna lake, Hasan	-do-	4.97
7.	Sharanbhasveshwara lake, Gulbarga	-do-	4.89
8.	Akkamahadevi lake, Haveri	-do-	2.64
9.	Kundawada lake, Davangere	-do-	3.41
10.	Kote Tavarekere lake, Chikmagalur	-do-	3.64
11.	Tripuranthkeshwar lake, Bidar	-do-	4.67
12.	Gowramma & Hambalmba	-do-	4.77
13.	Amanikere	-do-	13.37
14.	Banjara lake, Hyderabad	Andhra Pradesh	4.30
15.	Powai lake, Mumbai	Maharashtra	6.62
16.	Nine lakes in Thane	-do-	2.53
17.	Mahalaxmi lake, Vadagaon	-do-	1.85
18.	Rankala lake, Kolhapur	-do-	8.65
19.	Varhala Devi lake, Bhiwandi	-do-	4.60
20.	Sidheshwar	-do-	4.32
21.	Mansagar lake, Jaipur	Rajasthan	24.72
22.	Anasagar lake, Ajmer	-do-	15.28
23.	Pushkar	-do-	48.37
24.	Fatehsagar	-do-	41.86
25.	Pichola Lake, System, Udaipur	Rajasthan	84.75
26.	Ooty lake	Tamil Nadu	1.75
27.	Kodaikanal lake, Dindigul	-do-	10.42
28.	Three lakes of Agartala	Tripura	2.02
29.	Four lakes in Nainital	Uttarakhand	16.85
30.	Nainital lake, Nainital	-do-	47.97
31.	Rabindra Sarovar	West Bengal	6.96
32.	Mirik lake, Darjeeling	-do-	4.01
33.	Adi Ganga	-do-	24.94
34.	Dal lake, Sri Nagar	J&K	298.76
35.	Veli Akkulum lake, Thiruvananthpuram	Kerala	24.56
36.	Bindu Sagar lake, Bhubaneshwar	Orissa	3.50
37.	Rani talab, Rewa	Madhya Pradesh	3.31
38.	Sagar lake, Sagar	-do-	21.33
39.	Shivpuri Lakes (Jadav Sagar, Chandpatha), Shivpuri	-do-	51.99
40.	Mansi Ganga lake, Govardhan, Mathura	Uttar Pradesh	22.71
41.	Twin Lakes in Mokochung	Nagaland	25.83
	<b>Total</b>		<b>883.94</b>

**LIST OF PROJECTS COMPLETED DURING 2009-2010**

**Environment Research Programme (ERP)**

Sl.No.	Title of the Project	Name of Principal Investigator & Institute
1.	Exploitation of Cyanobacteria for metal binding, detoxification and metal removal from Aquatic Ecosystems.	Dr. Nirupama Malick, Agriculture and Food Engineering Department, IIT, Kharagpur-721302
2.	Phyto-removal of heavy metals from industrial effluents	Dr. Padma S. Vankar, Indian Institute of Technology, Kanpur, 302, Southern Laboratories Kanpur-208016, U.P.
3.	Geo-chemical assessment of fluoride content in rock/soil/water systems in Karbianglong District, Assam	Dr. P. Kotaky, North-East Institute of Science and Technology (Earlier RRL), Jorhat-785006, Assam
4.	Traditional Methods of Water Harvesting and its Impact on Environment in Bikaner District, Rajasthan	Dr. Jai Bharat Singh, Government Dungar College, Bikaner-334003, Rajasthan
5.	NAT2 gene polymorphism (RELP) in urinary bladder mucosa due to environmental pollutant exposure.	Dr. A.K. Mandal, Department of Pathology, Maulana Azad Medical College, Bahadur Shah Zafar Marg, New Delhi-110002
6.	Utilisation of agricultural waste for the development of useful advanced ceramics.	Dr. Japes Bera, Department of Ceramic Engineering, National Institute of Technology, Rourkela-769008, Orissa

**Ecosystem Research Scheme (ERS)**

Sl.No.	Title of the project	Name of Principal Investigator (PI) & Institute
1.	Biodiversity studies of Orthoptera in Kaziranga National Park, Assam"	Dr. (Mrs.) Nizara D. Bharthakur/Dr. N. Senthilkumar, Rain Forest Research Institute, P.B. No. 136, Deovan, Sotai, Jorhat-785001.
2.	14/40/2002-ERS/RE Status, Ecology and Conservation of striped Hyena ( <i>Hyaena hyaena</i> ) in Gir National Park and Sanctuary	Dr. Jamal A. Khan Wildlife Society of India, Department of Wildlife Sciences, Aligarh Muslim University, Aligarh-202 002
3.	Diversity and ecology of mites infesting medicinal plants of West Bengal	Dr. Goutam Kumar Saha Reader in Zoology University of Calcutta, 35, Ballygunge Circular Road, Kolkata-700 019.

## Annual Report 2009-2010

Sl.No.	Title of the project	Name of Principal Investigator (PI) & Institute
4.	Ecology and Biocontrol potential of the "Giant Coccinellid Predators of Aphids".	Prof. B.K. Agarwala Deptt. Of Life Sciences, Tripura University, Suryamaninagar-799130, Tripura(W).
5.	Studies on ecosystem level changes following the gregarious flowering of <i>Melocanna baccifera</i> in Mizoram".	Dr. F. Lalnunmawai Deptt. of Forestry, Mizoram University Tanhril Campus, Aizawal-796009. Mizoram
6.	Diversity and distribution of Asterinaceous fungi in India.	Dr. V.B. Hosagoudar Microbiology Division Tropical Botanic Garden & Research Institute Palode, Thiruvananthapuram -695 562, Kerala
7.	Restoration of certain Mining sites of Gujarat by application of VAM fungi	Dr. Arun Arya Reader in Botany Department of Botany, Faculty of Science, The M.S. University of Baroda, Vadodara-390002.

### Eastern and Western Ghats Research Programme (E&WGRP)

Sl.No.	Title of the project	Name of Principal Investigator (PI) & Institute
1.	Chemical loading into reservoirs: Investigation from selected watersheds of Periyar river in Western Ghatsm, Kerala	Dr. M.N. Muraleedharan Nair, CSD, Centre for Earth Science, Studies,. P.B. No. 7250, Akkulam, Thiruvananthapuram-695031
2.	Bioecology of spiders in Western Ghats of Kerala	Dr. P.A. Sabastian, Department of Zoology, Sacred Heart College, Thevara, Cochin-682013, Kerala
3.	A Study on the Herpetofaunal Communities of the Upper vaigai Plateau Western Ghats, India	Dr. S. Bhupathy, Salim Ali Centre for Ornithology & Natural History (SACON), Anaikatty, Coimbatore-641108, Tamil Nadu
4.	Herbivorous Arthropod fauna associated with some ferns of Western Ghats of Southern India	Dr. R.W. Alexander Jesusasan, Department of Zoology, Madras Christian College, Chennai-600059
5.	Ecosystem structure and dynamism, biodiversity, human dimensions and their linkages of Eringole Sacred Grove in the Western Ghats of India	Dr. K.K.N. Nair, Kerala Forest Research Institute , Peechi, Thrissur, Kerala-680653
6.	Need for conserving forest canopies-Assessing the diversity of canopy insects in the Western Ghats	Shri Y.B. Srinivasa, Institute of Wood Science and Technology, 18 <sup>th</sup> Cross, Malleswaram, Bangalore-560003

## Ministry of Environment & Forests

Sl.No.	Title of the project	Name of Principal Investigator (PI) & Institute
7.	Tolerance of indigenous forest species to degraded Lateritic soils of Kerala	Dr. M.P. Sujatha, Kerala Forest Research Institute, Peechi, Kerala-680653
8.	Taxonomy Studies on family Noctuoidea: (Lepidoptera) from Western Ghats of India	Dr. Jagbir Singh, Department of Zoology, Punjabi University, Patiala-147002
9.	Biodiversity of mites associated with insects in Western Ghats	Dr. K. Ramaraju, Centre for Plant Protection Studies, Tamil Nadu Agricultural University, Coimbatore-641003
10.	Ecology of Co-existing owls, Spotted owl (Owlet (Athene brama) and Barn owl (Tyto alba) in Madurai District Tamil Nadu South India	Dr. R. Santhana Krishnan, Deptt. Of Zoology, Saraswathi Narayanan College, Madurai-625022
11.	Studies on the biodiversity of hyphomycetes in dry deciduous forest soils and litters of semi-arid tropical areas of the Puttaparthi Mandal, Ananthapur District	Dr. B.S. Vijayakumar, Sri Satya Sai Institute of Higher Learning, Prasanthinilayam-515134. Andhra Pradesh.
12.	Establishment of in-vitro gene bank Nothopodytes foetida(Wt.) Sleumer-Threatened species of Western Ghats	Dr. D.H. Tejavathi, Prof. of Botany, Bangalore University, Bangalore-560056

### Policy Research Project

Sl.No.	Title of the project	Name of Principal Investigator & Institute
1.	Corporate Environmental responsibility and the Market: study of Indian manufacturing firms.	Prof. P. D. Jose, Indian Institute of Management (IIM), Bengaluru -560076, Karnataka
2.	Formulation of a Sui-Generis Regime for traditional knowledge (Ethnobiology)	Prof. P. Pushapangadan Institute for Herbal and Biotech Product Development, Triruvanthapuram -695005, Kerala
3.	Societal Risks "Policy for Managing Societal Risks in India".	Prof. A. Damodaran, Indian Institute of Management (IIM), Bengaluru -560076, Karnataka

### National Natural Resource Management System (NNRMS)

Sl.No.	Title of the project	Name of Principal Investigator & Institute
1.	Forest Type Mapping of India's Forest	Dr. Subhash Ashutosh, Joint Director, Forest Survey of India, Kaulagarh Road, Dehradun-248195, Uttarakhand
2.	Snow and Glacier Studies	Dr. Ajai, Group Director, Space Application Centre, Ambawadi Vistar P.O., Ahmadabad-380015

## Biosphere Reserves

Sl.No.	Title of the project	Name of Organization
1.	Macrofungal Biodiversity of Nanda Devi Biosphere Reserve and it's in vitro conservation	Punjab University, Chandigarh – 160 014
2.	Studies on the animal habitat interaction in the buffer zone of Nanda Devi Biosphere Reserve	Wildlife Institute of India, Dehradun
3.	Study on the biodiversity of Agaricales at Sikkim Himalaya	University of Calcutta, Kolkata.

## National River Conservation Directorate

Projects completed during 01-04-2009 to 31-10-2009

S. No.	Name of the Project/ Scheme	Name of the Town/ City
<b>Haryana</b>		
1.	Additional Sewerage Works	Faridabad (YAP-II)
2.	Sewer Lines (Phase-II/ Stage-II)	Karnal (YAP-II)
3.	Sewer Lines (Phase-II/ Stage-II)	Panipat (YAP-II)
4.	Additional Sewerage Works	Panipat (YAP-II)
5.	Sewer Line (Phase-II/ Stage-II)	Yamunanagar-Jagdhari (YAP-II)
6.	Additional Sewerage Works	Yamunanagar-Jagdhari (YAP-II)
<b>Karnataka</b>		
7.	Sewage Treatment Plant	Nanjangud (ORCP)
<b>Uttar Pradesh</b>		
8.	River Front Development	Lucknow ( Gomti-II)
<b>Uttarakhand</b>		
9.	Interception & Diversion (Part-II)	Sri-Nagar (S/C Towns)
<b>West Bengal</b>		
10.	Lifting Station-I	Asansol (DAP)
11.	Sewage Treatment Plant (Zone-B) 13.17 mld	Asansol (DAP)
12.	Sewage Treatment Plant (5.90 mld)	Barrackpore (GAP-II), (Main Stem)
13.	Electricity Crematoria (Madhyagram)	Bansberia (GAP-II), (Main Stem)
14.	STP ( mld)	Budge-Budge (GAP-II), (Main Stem)
15.	Sewage Treatment Plant	Budge-Budge (GAP-II), (Main Stem)
16.	Afforestation	Kharda (Extended), (S/C Towns)
17.	Sewage Treatment Plant (a)	Naihati, (S/C Towns)
18.	Sewage Treatment Plant (b)	Naihati, (S/C Towns)
19.	Sewage Treatment Plant	Naihati, (S/C Towns)
20.	Interception and Diversion	Rishra, (GAP-II), (Main Stem)
21.	Lifting Station (A)	Rishra, (GAP-II), (Main Stem)

<b>NRCP</b>	→	National River Conservation Plan
<b>S/C Towns</b>	→	Supreme Court Order Towns
<b>GAP-II</b>	→	Ganga Action Plan Phase-II
<b>DAP</b>	→	Damodar Action Plan

**ANNEXURE-V**

**STATE-WISE AND TOWN-WISE DETAILS OF APPROVED COST (CCEA),  
SANCTIONED COST AND EXPENDITURE IN 167 TOWNS UNDER  
NATIONAL RIVER CONSERVATION PLAN**

Sl. No.	STATE/TOWN	River No.	River	Sanctioned Cost (DPR) (Rs. in lakh)
<b>I</b>	<b>ANDHRA PRADESH</b>			
1	Bhadrachalam	1	Godavari	200.70
2	Mancherial		Godavari	231.30
3	Rajamundry		Godavari	2178.60
4	Ramagundam		Godavari	574.55
5	Hyderabad	2	Musi	33565.53
	<b>Sub Total :</b>			<b>36750.68</b>
<b>II</b>	<b>BIHAR</b>			
6	Arrah	3	Ganga	34.25
7	Barahya		Ganga	40.48
8	Barh		Ganga	18.90
9	Bhagalpur		Ganga	20.09
10	Buxar		Ganga	7.63
11	Chapra		Ganga	0.00
12	Fatwah		Ganga	18.02
13	Hazipur		Ganga	0.00
14	Kahelgaon		Ganga	0.00
15	Mokamah		Ganga	0.00
16	Munger		Ganga	40.30
17	Patna		Ganga	178.07
18	Sultanganj		Ganga	37.43
	<b>Sub Total :</b>			<b>395.18</b>
<b>III</b>	<b>DELHI</b>			
19	Delhi	4	Yamuna	18064.08
	YAP-II		Yamuna	46935.45
	<b>Sub Total</b>			<b>64999.53</b>



## Annual Report 2009-2010

Sl. No.	STATE/TOWN	River No.	River	Sanctioned Cost (DPR) (Rs. in lakh)
<b>IV GOA</b>				
20	Panaji	5	Mandovi	1409.52
	<b>Sub Total</b>			<b>1409.52</b>
<b>V GUJARAT</b>				
21	Ahemadabad	6	Sabarmati	10195.87
	<b>Sub Total :</b>			<b>10195.87</b>
<b>VI HARYANA</b>				
22	Chhachhrauli		Yamuna	104.79
23	Faridabad		Yamuna	7573.57
24	Gharaunda		Yamuna	141.27
25	Gohana		Yamuna	347.51
26	Gurgaon		Yamuna	2764.64
27	Indri		Yamuna	136.88
28	Karnal		Yamuna	2493.94
29	Palwal		Yamuna	1054.19
30	Panipat		Yamuna	4351.02
31	Radaur		Yamuna	108.86
32	Sonepat		Yamuna	2263.40
33	Yamunanagar-Jagdri		Yamuna	2880.22
	YAP-II		Yamuna	6342.97
	<b>Sub Total:</b>			<b>30563.26</b>
<b>VII JHARKHAND</b>				
34	Ghatshila	7	Subarnarekha	68.02
35	Jamshedpur		Subarnarekha	174.52
36	Ranchi		Subarnarekha	133.07
37	Bokaro-Kangali	8	Damodar	9.87
38	Chirkunda		Damodar	0.00
39	Dugdha		Damodar	0.00
40	Jharia		Damodar	0.00

Ministry of Environment & Forests

Sl. No.	STATE/TOWN	River No.	River	Sanctioned Cost (DPR) (Rs. in lakh)
41	Ramgarh		Damodar	16.17
42	Sahebganj		Ganga	20.67
43	Sindri		Damodar	0.00
44	Sudamdih		Damodar	9.87
45	Telmachu		Damodar	5.53
<b>Sub Total :</b>				<b>437.73</b>
<b>VIII KARNATAKA</b>				
46	Bhadravati	9	Bhadra	376.98
47	Davangere	10	Tungabhadra	466.05
48	Harihara		Tungabhadra	249.94
49	K.R.Nagar	11	Cauvery	57.80
50	Kollegal		Cauvery	108.65
51	Nanjangud		Cauvery	223.86
52	Shimoga	12	Tunga	370.38
53	Srirangapatna		Cauvery	144.01
54	Bangalore	13	Pennar	4627.00
<b>Sub Total :</b>				<b>6624.67</b>
<b>IX KERALA</b>				
55	Pamba	14	Pamba	1844.98
<b>Sub Total :</b>				<b>1844.98</b>
<b>X MADHYA PRADESH</b>				
56	Bhopal	15	Betwa	339.32
57	Burhanpur	16	Tapti	481.47
58	Chapara	17	Wainganga	39.85
59	Indore	18	Khan	4019.20
60	Jabalpur	19	Narmada	133.85
61	Keolari		Wainganga	36.16
62	Mandideep		Betwa	36.13

## Annual Report 2009-2010

Sl. No.	STATE/TOWN	River No.	River	Sanctioned Cost (DPR) (Rs. in lakh)
63	Nagda	20	Chambal	310.79
64	Seoni		Wainganga	25.10
65	Ujjain	21	Kshipra	1804.96
66	Vidisha		Betwa	447.47
67	Hoshangabad		Narmada	1299.07
68	Rewa	22	Beehar	1944.00
69	Chitrakut	23	Mandakini	620.42
<b>Sub Total :</b>				<b>11537.83</b>
 <b>XI MAHARASHTRA</b>				
70	Karad	23	Krishna	318.72
71	Nanded		Godavari	1346.76
72	Nashik		Godavari	6201.76
73	Sangli		Krishna	2555.27
74	Trimbakeshwar		Godavari	1164.00
75	Prakkasha	24	Tapi	244.43
76	Kolhapur	27	Panchganga	7429.00
<b>Sub Total :</b>				<b>19259.94</b>
 <b>XII NAGALAND</b>				
77	Dimapur	25	Diphu and Dhansiri	3174.00
<b>Sub Total :</b>				<b>3174.00</b>
 <b>XIII ORISSA</b>				
78	Chandbali	26	Brahamini	34.90
79	Cuttack	27	Mahanadi	804.30
80	Dharamshala		Brahamini	19.63
81	Talcher		Brahamini	370.20
82	Puri		Coastal Area	8044.86
<b>Sub Total :</b>				<b>9273.89</b>

## Ministry of Environment & Forests

Sl. No.	STATE/TOWN	River No.	River	Sanctioned Cost (DPR) (Rs. in lakh)
<b>XIV PUNJAB</b>				
83	Jalandhar	28	Satluj	5221.78
84	Ludhiana		Satluj	13351.21
85	Phagwara		Satluj	1386.21
86	Phillaur		Satluj	112.06
87	Kapurthala		Satluj	1256.26
88	Sultanpur Lodhi		Satluj	240.74
	<b>Sub Total</b>			<b>21568.26</b>
<b>XV RAJASTHAN</b>				
89	Keshoraipattan		Chambal	72.55
90	Kota		Chambal	15022.85
	<b>Sub Total</b>			<b>15095.40</b>
<b>XVI SIKKIM</b>				
91	Gangtok	29	Rani Chu	2516.20
92	Singtom		Rani Chu	632.82
93	Ranipool		Rani Chu	590.24
	<b>Sub Total</b>			<b>3739.26</b>
<b>XVII TAMIL NADU</b>				
94	Bhiwani		Cauvery	392.84
95	Chennai	32, 33	Adyar, Cooum	40425.46
96	Erode		Cauvery	1472.13
97	Kumarapalayam		Cauvery	232.14
98	Pallipalayam		Cauvery	184.67
99	Trichy		Cauvery	430.05
100	Karur		Cauvery	3105.32
101	Kumbakonam		Cauvery	4410.45
102	Mayiladuthurai		Cauvery	4481.04
103	Trichirappalli		Cauvery	11667.00

## Annual Report 2009-2010

Sl. No.	STATE/TOWN	River No.	River	Sanctioned Cost (DPR) (Rs. in lakh)
104	Thanjavur	32	Vennar	6274.76
105	Madurai	33	Vaigai	13024.18
106	Tirunelveli	34	Tamrabarani	5492.90
<b>Sub Total :</b>				<b>91592.95</b>
<b>XVIII UTTAR PRADESH</b>				
107	Agra		Yamuna	8429.50
108	Allahabad		Ganga	5853.04
109	Anupshaher		Ganga	450.38
110	Bijnor		Ganga	434.43
111	Chunar		Ganga	39.53
112	Etawah		Yamuna	559.76
113	Farrukkabad		Ganga	0.00
114	Garhmukteshwar		Ganga	130.94
115	Ghaziabad		Yamuna	9457.95
116	Ghazipur		Ganga	55.93
117	Jaunpur	35	Gomti	377.17
118	Kanpur		Ganga	8276.53
119	Lucknow		Gomti	31067.49
120	Mathura		Yamuna	2486.12
121	Mirzapur		Ganga	261.69
122	Mughal Sarai		Ganga	148.08
123	Muzaffar Nagar		Yamuna	1285.94
124	NOIDA		Yamuna	2704.69
125	Saharanpur		Yamuna	2486.62
126	Saidpur		Ganga	0.00
127	Sultanpur		Gomti	434.65
128	Varanasi		Ganga	4161.21
129	Vrindavan		Yamuna	855.92
	YAP-II			11507.94
<b>Sub Total (UP)</b>				<b>91465.51</b>

## Ministry of Environment & Forests

Sl. No.	STATE/TOWN	River No.	River	Sanctioned Cost (DPR) (Rs. in lakh)
<b>XIX</b>	<b>UTTARAKHAND</b>			
130	Badrinath		Ganga	1208.07
131	Deoprayag		Ganga	1217.71
132	Gopeshwar		Ganga	30.36
133	Hardwar & Rishikesh		Ganga	4989.62
134	Joshimath		Ganga	16.90
135	Karnaparag		Ganga	888.84
136	Ranipur		Ganga	392.55
137	Rudraprayag		Ganga	1335.48
138	Srinagar		Ganga	590.05
139	Uttar Kashi		Ganga	816.46
	<b>Sub Total</b>			<b>11486.04</b>
<b>XX</b>	<b>WEST BENGAL</b>			
140	Andal		Damodar	17.85
141	Asansol		Damodar	340.66
142	Bhadreshwar & Champdani		Ganga	943.87
143	Baidyabati		Ganga	1192.76
144	Bansberia		Ganga	896.04
145	Barrackpore		Ganga	3778.81
146	Budge-Budge		Ganga	826.72
147	Chakdah		Ganga	128.43
148	Circular Canal		Ganga	893.63
149	Dhulian		Ganga	144.87
150	Diamond Harbour		Ganga	375.07
151	Durgapur		Damodar	21.20
152	Garulia		Ganga	470.73
153	Gayeshpur, Halilshar & Kancharapara		Ganga	2002.51
154	Jangipur		Ganga	144.64
155	Jijganj Azimganj		Ganga	451.93
156	Katwa		Ganga	295.71
157	Kharda (Extended)		Ganga	545.35

## Annual Report 2009-2010

Sl. No.	STATE/TOWN	River No.	River	Sanctioned Cost (DPR) (Rs. in lakh)
158	Konnagar		Ganga	1362.52
159	Maheshtala		Ganga	1131.70
160	Murshidabad		Ganga	228.69
161	Naihati		Ganga	1903.25
162	North Barrackpore		Ganga	1428.58
163	Raniganj		Damodar	18.70
164	Rishra		Ganga	1020.54
165	Tolly's Nallah		Ganga	2465.17
166	Uttarpara Kotrung		Ganga	929.31
167	Siliguri	36	Mahananda	5488.23
<b>Sub Total (W.B.)</b>				<b>29447.47</b>
<b>Total : (20 States) :</b>				<b>460861.96</b>
<b>CETP, Calcutta (West Bengal)</b>				
<b>ESTT. &amp; R&amp;D</b>				<b>8292.00</b>
<b>OVER ALL TOTAL :</b>				<b>469153.96</b>

**IMPLEMENTING AGENCIES OF STATES UNDER NATIONAL RIVER CONSERVATION PLAN**

**S.No. Nodal Implementing Agency**

**1. ANDHRA PRADESH**

i) Engineer-in Chief,  
Public Health Engg. Department, A.C. Guards,  
Hyderabad

ii) Managing Director,  
Hyderabad Metropolitan Water Supply &  
Sewerage Board, Khairtabad,  
Hyderabad -500 004

iii) Managing Director,  
AP Tourism Corporation Ltd.,  
"Tourism House", 3-5-891,  
Himayat Nagar, Hyderabad-500029,  
Andhra Pradesh

**2. BIHAR**

Managing Director,  
BRJP, West Boring Canal Road, Patna,  
Bihar -800 001

**3. GOA**

Executive Engineer, WD -III, PHE  
Goa Public Works Deptt. St. INEZ, Panaji, Goa

**4. GUJARAT**

Municipal Commissioner,  
Ahmedabad Municipal Corporation,  
Ahmedabad-380 001.

**5. HARYANA**

Engineer-in-Chief  
PWD Public Health Branch.  
Bay No. 13-18 Sector-4, Panchkula, Haryana

**6. JHARKHAND**

Managing Director,  
MADA, Luby Circular Road, Dhanbad, Jharkhand,

**7. KARNATAKA**

i) Managing Director,  
Karnataka Urban Water Supply & Drainage Board,  
KHB Complex, Cauvery Bhawan, K.G. Road,  
Bangalore-560 009.

ii) Member Secretary,  
Kr S.P.C.B., 6, 7, 8 & 9<sup>th</sup> floor,  
Public Utility Building, M.G. Road,  
Bangalore-560 001, Karnataka.



**8. KERALA**

Managing Director,  
Kerala Water Authority, Jala Bhawan,  
Thiruvananthapuram, Kerala

**9. MADHYA PRADESH**

i) Member Secretary,  
M.P. Pollution Control Board, Paryavaran Parisar,  
E-5, Arera Colony, Bhopal-462 013

ii) E-N-C, PHED,  
Govt. of M.P., Satpura Bhawan, Bhopal,  
Madhya Pradesh

**10. MAHARASTRA**

i) Member Secretary,  
Maharashtra Jeevan Pradhikaran (MJP)  
4<sup>th</sup> floor, Express Tower, Nariman Point,  
Maharashtra

ii) Commissioner,  
Nasik Municipal Corporation,  
Nasik, Maharashtra

**11. NAGALAND**

Chief Engineer,  
Public Health Engineering, Department,  
Govt. of Nagaland, Kohima

**12. NCT DELHI**

i) Delhi Jal Board,  
Varunalaya Phase-II, Jhandewalan,  
Delhi-110 005.

ii) Additional Commissioner (S&JS)  
Municipal Corporation of Delhi,  
I.P. Estate, New Delhi-110 002

**13. ORISSA**

Member Secretary/Chief Engineer,  
Orissa Water Supply and Sewerage Board,  
Satya Nagar, Bhubaneswar.

**14. PUNJAB**

Managing Director,  
Punjab Water Supply & Sewerage Board,  
Plot I-B, Sector-27A, Madhya Marg, Chandigarh

**15. RAJASTHAN**

Chief Engineer (Hqs) PHED,  
2, Civil Lines, Govt. of Rajasthan, Jaipur-302 006.

**16. SIKKIM**

PCE-cum-Secretary,  
Water Security & PHED, Govt. of Sikkim, Gangtok

**17 TAMIL NADU**

i) Managing Director,  
CMWSSB, No-1, Pumping Station Road,  
Chintadripet, Chennai-600 002

iii) Secretary,  
Municipal Admin & Water Supply,  
Govt. of Tamil Nadu, Secretariat Chennai

ii) Managing Director,  
TWAD Board, Chepauk, Chennai-600 005

**18. UTTAR PRADESH**

Managing Director,  
U.P. Jal Nigam, 6, Rana Pratap Marg, Lucknow

**19. UTTRAKHAND**

Managing Director  
Uttaranchal Peyjal Nigam,  
11, Mohini Road, Dehradun

**20. WEST BENGAL**

i) Chief Executive Officer,  
KMDA, Prashasan Bhawan,  
DD-I, Sector-I, Kolkata-700 064

ii) Director of Industries,  
Commerce & Industries Dept.,  
Govt. of W. Bengal, New Secretariat  
Building, 9<sup>th</sup> Floor, 1, K.S. Roy Road,  
Kolkata-700 001

**LIST OF WETLANDS IDENTIFIED UNDER NATIONAL WETLAND CONSERVATION PROGRAMME**

(\* Twenty five Wetlands of International Importance from India under Ramsar Convention)

S.No.	State/UT	S.No.	Name of Wetlands
1.	Andhra Pradesh	1.	Kolleru *
2.	Assam	2.	Deepar Beel *
		3.	Urpad Beel
		4.	Sone Beel
3.	Bihar	5.	Kabar
		6.	Barilla
		7.	Kusheshwar Asthan
4.	Gujarat	8.	Nalsarovar
		9.	Great Rann of Kachh
		10.	Thol Bird Sanctuary
		11.	Khijadiya Bird Sanctuary
		12.	Little Rann of Kachh
		13.	Pariej
		14.	Wadhvana
		15.	Nanikakrad
5.	Haryana	16.	Sultanpur
		17.	Bhindawas
6.	Himachal Pradesh	18.	Renuka *
		19.	Pong Dam *
		20.	Chandratal *
		21.	Rewalsar
		22.	Khajjiar
7.	Jammu & Kashmir	23.	Wullar *
		24.	Tso Morari *
		25.	Tisgul Tso & Chisul Marshes
		26.	Hokersar *
		27.	Mansar-Surinsar *
		28.	Ranjitsagar
		29.	Pangong Tsar



## Ministry of Environment & Forests

S.No.	State/UT	S.No.	Name of Wetlands
		30.	Gharana
		31.	Hygam
		32.	Mirgund
		33.	Shalbugh
		34.	Chushul & Hanley
8.	Jharkhand	35.	Udhwa
		36.	Tilaiya Dam
9.	Karnataka	37.	Magadhi
		38.	Gudavi Bird Sanctuary
		39.	Bonal
		40.	Hidkal & Ghataprabha
		41.	Heggeri
		42.	Ranganthittu
		43.	K.G. Koppa wetland
10.	Kerala	44.	Ashtamudi *
		45.	Sasthamkotta *
		46.	Kottuli
		47.	Kadulandi
		48.	Vembnad Kol *
11	Madhya Pradesh	49.	Barna
		50.	Yashwant Sagar
		51.	Wetland of Ken River
		52.	National Chambal Sanctuary
		53.	Ghatigaon
		54.	Ratapani
		55.	Denwa Tawa wetland
		56.	Kanha Tiger Reserve
		57.	Pench Tiger Reserve
		58.	Sakhyasagar
		59.	Dihaila
		60.	Govindsagar
		61.	Sirpur

## Annual Report 2009-2010

S.No.	State/UT	S.No.	Name of Wetlands
12.	Maharashtra	62.	Ujni
		63.	Jayakawadi
		64.	Nalganga wetland
13.	Manipur	65.	Loktak *
14.	Mizoram	66.	Tamdil
		67.	Palak
15.	Orissa	68.	Chilka *
		69.	Kuanria wetland
		70.	Kanjia wetland
		71.	Daha wetland
		72.	Anusupa
16.	Puducherry	73.	Ousteri lake
17.	Punjab	74.	Harike *
		75.	Ropar *
		76.	Kanjli *
		77.	Nangal
18.	Rajasthan	78.	Sambhar *
19.	Sikkim	79.	Khechuperi Holy Lake
		80.	Tamze Wetland
		81.	Tembaao Wetland Complex
		82.	Phendang Wetland Complex
		83.	Gurudokmar Wetland
		84.	Tsomgo wetland
20.	Tamil Nadu	85.	Point Calimer *
		86.	Kaliveli
		87.	Pallaikarni
21.	Tripura	88.	Rudrasagar *
		89.	Gumti reservoir
22.	Uttar Prdaesh.	90.	Nawabganj
		91.	Sandi
		92.	Lakh Bahoshi
		93.	Samaspur



## Ministry of Environment & Forests

S.No.	State/UT	S.No.	Name of Wetlands
		94.	Alwara Wetland
		95.	Semarai Lake
		96.	Nagaria lake
		97.	Keetham Lake
		98.	Shekha wetland
		99.	Saman Bird Sanctuary
		100.	Sarsai Nawar
		101.	Patna Bird Sanctuary
		102.	Chandotal
		103.	Tal Bhaghel
		104.	Taal Ganbhirvan & Taal Salona
		105.	Aadi Jal Jeev Jheel
23.	Uttarakhand	106.	Ban Ganga Jhilmil Tal
		107.	Asan
24.	West Bengal	108.	East Calcutta Wetland *
		109.	Sunderbans
		110.	Ahiron Beel
		111.	Rasik Beel
		112.	Santragachi
25.	Meghalaya	113.	Patlakhawa- Rasomati
		114.	Umiam lake
26.	UT (Chandi-garh)	115.	Sukhna
	Madhya Pradesh	116.	Bhoj Wetland *
	Orissa	117.	Bhitarkanika Mangroves *
	Rajasthan	118.	Keoladeo National Park *
	Uttar Pradesh	119.	Upper Ganga *

**Names of Nodal Agencies of NGC Programme**

S.No.	State/UT	State Nodal Agency
1	Andhra Pradesh	Directorate of NGC, Deptt. of Environment, Forests, Science & Tech., Govt. of A.P., No. 18, A-Block, Buddha Bhavan Complex, MG Road, Hyderabad - 500 003
2	Andaman & Nicobar (U.T.)	H. Q. Circle, Department of Forests, Vansadan, Haddo, Port Blair - 741002
3	Arunachal Pradesh	Department of Environment & Forests, Government of Arunachal Pradesh, Arunachal Pradesh State Pollution Control Board, Environment & Forests Office Complex, 'P' Sector, Itanagar - 791 111
4	Assam	Assam Science, Technology and Environment Council, Bigyan Bhawan, G. S. Road, Guwahati - 781 005
5	Bihar	Bihar State Poll. Control Board, Beltron Bhawan, 2 <sup>nd</sup> floor, Lal Bahadur Shastri Nagar, Patna - 800 023
6	Chandigarh (UT)	Department of Environment, Chandigarh Administration, Additional Town Hall Building, 1 <sup>st</sup> Floor, Sector -17-, Chandigarh -160 017
7	Chhattisgarh	Chhattisgarh Environment Conservation Board, 1 - Tilak Nagar, Shiv Mandir Chowk, Main Road, Avanti Vihar, Raipur - 492 006
8	Dadra & Nagar Haveli (UT)	Pollution Control Committee (PCC), DNH, Silvassa - 396230
9	Daman & Diu (UT)	Pollution Control Committee, Fort Area, Daman & Diu, Moti Daman - 396 220
10	Delhi (NCT)	Eco Club Society of Delhi, Department of Environment, Govt. of NCT of Delhi, Level -6, C-Wing, Delhi Secretariat, I.P Estate, New Delhi - 110 002
11	Goa	Goa State Council of Science, Technology & Environment, Opp. Saligao Seminary, Saligao, Barceze, Goa - 403 511
12	Gujarat	Gujarat Ecological Education and Research Foundation (GEER), Near Indroda Nature Park, Sec. - 9, Gandhi Nagar - 382 009



## Ministry of Environment & Forests

S.No.	State/UT	State Nodal Agency
13	Haryana	Haryana State Pollution Control Board, Plot No. C-11, Sector -6, Panchkula -134 101
14	Himachal Pradesh	State Council for Science, Technology & Environment, 34, SDA Complex, Kasumpti, Shimla -171 009
15	Jammu & Kashmir	(May to Oct) Srinagar- Sheikh-ul Alam Campus, Rajbagh behind Govt Silk Factory, Srinagar- Kashmir (Nov to April) J & K State Pollution Control Board Jammu- Parivesh Bhawan, Glandni Transport Nagar (Narwal) Jammu
16	Jharkhand	Jharkhand State Pollution Control Board, T. A. Division Building, Ground Floor, H. E. C., Dhurwa, Ranchi - 834 004
17	Karnataka	Environmental Management & Policy Research Institute, Department of Forests, Ecology and Environment, Government of Karnataka, "Hasiru Bhavana", Doresanipalya Forest Campus, Vinayakanagar Circle, J. P. Nagar, 5 <sup>th</sup> Phase, Bangalore - 560 078
18	Kerala	Kerala State Council for Science, Tech. & Environment, Shashtra Bhawan, Pattom, Thiruvanthapuram - 695 004
19	Lakshadweep (UT)	Deptt. of Environment and Forests, UT Administration of Lakshadweep, Kavaratti - 682555
20	Madhya Pradesh	Environment Planning and Coordination Organisation (EPCO), Kachnar, Parayavaran Parisar, E-5, Sector, Arera Colony, Bhopal - 462 106
21	Maharashtra	Maharashtra Ekatmik Padik Jamin Vikas Yantrana, Directorate of Social Forestry, Maharashtra State, Central Administrative Building, Ground Floor, Pune - 411 001
22	Manipur	Manipur Pollution Control Board, Lamphelpat, Near Imphal West D.C. Office Complex, Imphal-795004
23	Meghalaya	Forests & Environment Department, Sylvan House, Lower Lauchumere, Shillong - 793 001
24	Mizoram	Mizoram State Pollution Control Board, MG Road, Khatla, Aizawl - 796 001



## Annual Report 2009-2010

S.No.	State/UT	State Nodal Agency
25	Nagaland	Nagaland Pollution Control Board, Signal Point, Dimapur – 797112
26	Orissa	Centre for Environmental Studies (CES), Forests & Environment Department, Govt. of Orissa, N-1/247, IRC Village, Nayapalli, Bhubaneswar – 751 015
27	Pudducherry (UT)	Environment Education Cell, State Training Centre, Perunthalivar Kamaraj Education Complex, 'B' Block, IV Floor, Anna Nagar, Puducherry – 605 005
28	Punjab	Punjab State Council for Science and Technology, Adjacent Sacred Heart School, Sector – 26, Post Box No. 727, Chandigarh - 160019
29	Rajasthan	Rajasthan Rajya Bharat Scouts & Guides, Rajya Mukhyalaya, Jawahar Lal Nehru Marg, Bajaj Nagar, Jaipur – 302 015
30	Sikkim	State Environment Committee, Deptt. of Forests, Environment & Wildlife, Government of Sikkim, Deorali –737 102
31	Tamil Nadu	Environment Management Agency of Tamil Nadu (EMAT), Govt. of Tamil Nadu, Ground Floor, Panagal Building, No.1, Jeenis Road, Saidapet, Chennai-600015
32	Tripura	Tripura State Pollution Control Board, Vigyan Bhawan, Pt. Nehru Complex, Gorkha Basti, P.O. Kunjaban, Agartala, Tripura (W) – 799 006
33	Uttar Pradesh	Directorate of Environment, Vineet Khand-1, Gomti Nagar, Lucknow
34	Uttarakhand	Uttarakhand Sabhi Ke Liye Shiksha Parishad, SSA, Shiksha Shankul, Mayur Vihar, Sahastradhara Road, Dehradun – 248 001
35	West Bengal	West Bengal Pollution Control Board, Department of Environment, Government of West Bengal, Paribesh Bhawan, 10A, Block – LA, Sector III, Bidhannagar, Kolkata – 700 098

List of RRAs under NEAC 2009-10

S.No.	Name of Organisations	Area of Jurisdiction
1.	Sri Swarupa Nistha Ashrama, Philosophical Welfare Society, H.No. 1-1189-99, 1 <sup>st</sup> Floor, N.G.O. Colony, Kadiri-515591, Anathapur Distt. Andhra Pradesh	Andhra Pradesh (South)
2.	Deccan Development Society, 101, Kishan Residency House No.1-11-242/1, Street No.5, Begum Pet, Hyderabad- 500 016	Andhra Pradesh (North)
3.	Assam Science Society, P.B.No.78, Lamb Road, Lataasil, Guwahati-781 001	Assam
4.	Rural Youth Coordination Centre, Camp Office: House No. 210, Indira Nagar Rajapur, Post-Patna G.P.O., Distt-Patna-800 001 Head Office: At. Po. Distt. Saran, Bihar Pin-841401	Bihar
5.	Jan Kalyan Parishad, Moh. Namana Kala Ring Road, (Near Comel School), Ambikapur, Distt. -Surguja, Chattisgarh-497001	Chhattisgarh
6.	Indian Environmental Society, U-112, Vidhata House, 3 <sup>rd</sup> Floor, Vikas Marg, Shakarapur, Delhi- 110 092 Branch Office: Kaveri Building, Ground Floor Sanjay Palace, Agra	Delhi & Western U.P.
7.	Vikram Sarabhai Centre for Development Interaction (VIKSAT), Nehru Foundation for Development, Thaltej Tekra, Vastrapur Road, Ahmedabad- 380 054	Gujarat & Daman Diu
8.	Haryana Nav Yuvak Kala Sangam (HNYKS) 46, Sector-I, Rohtak-124001, Haryana	Haryana
9.	State Council for Science, Technology & Environment H.P. 34, SDA Complex, Kasumpti, Shimla- 171 009	Himachal Pradesh
10.	World Wide Fund for Nature-India, Jammu & Kashmir State Office, C/O Centre for Environment Education & Training, New University campus, Jammu-180006	Jammu
11.	The NGOs Co-ordination Federation (J&K), Usman Complex Solina, Srinagar-190009 (J&K)	Kashmir including Ladakh

## Annual Report 2009-2010

S.No.	Name of Organisations	Area of Jurisdiction
12.	Gram Vikas Kendra, K-3/57, Hans Stoehr Road, TELCO Colony, Jamshedpur- 831 004	Jharkhand
13.	Karnataka Rajya Vijnana Parishat, Vijnana Bhawan, No. 24 /2 &24/3, 21 <sup>st</sup> Main Road, Banashankari-II Stage, Bangalore- 560 070	Karnataka
14.	Centre for Environment & Development, Thozhuvancode, Vattiyoorkavu P.O., Thiruvananthapuram, Kerala -695013	Kerala, Lakshadweep & Minicoy Island
15.	Bhartiya Agro-Industries Foundation (BAIF), Development Research Foundation, BAIF Bhawan, Dr. Manibhai Desai Nagar, National Highway No. 4, Warje, Pune- 411 058	Maharashtra, Goa & Dadara Nagar Haveli
16.	Environment & Ecology Wing, Deptt. of Environment and Forests, Government of Manipur, Porompat, Near D.C. Officer, Imphal (east)-795 001	Manipur
17.	Environmental Planning & Coordination Organisation (EPCO), 'Kachnar' Paryavaran Parisar, E-5, Arera Colony, Bhopal- 462 016	Madhya Pradesh
18.	Center for Environment Protection (CEP), B-27/1, Tuikual South, Aizwal-796001, Mizoram	Mizoram
19.	Nagaland Pollution Control Board, Signal Point, Dimapur, Nagaland-797112	Nagaland
20.	Centre for Environment Studies, Forests and Environment Department, Government of Orissa, N-3/56 I.R.C. Village, Bhubaneshwar- 751015	South Orissa
21.	Animal Welfare Society of Orissa, Branch Office: At/Po- Bhandaripokhari, Distt-Bhadrak, Orissa Head Office: Qr. No. 4R-2, Unit -8 Gopbandhu Square, Bhubaneshwar -751012	North Orissa
22.	Punjab State Council for Science & Technology, MG SIPA Building, Near Sacred Heart Public School, Sector-26, Chandigarh- 160 019	Punjab & Chandigarh
23.	Consumer Unity & Trust Society (CUTS), D-217, Bhaskar Marg, Bani Park, Jaipur-302016, Rajasthan	Rajasthan
24.	C.P. Ramaswamy Iyer Foundation, The grove, 1-Eldmas Road, Alwerpet, Chennai- 600 018	Tamilnadu (North) & Andaman Nicobar



## Ministry of Environment & Forests

S.No.	Name of Organisations	Area of Jurisdiction
25.	C.P. Ramaswamy Environment Education Centre, No. 1-A, Eldams Road, Chennai- 600 018	Pondicherry
26.	PEACE Trust, Near Police Colony, Trichy Road, Dindigul, Tamil Nadu-624005	Tamilnadu (South)
27.	Tripura State Pollution Control Board, Pandit Nehru Complex, Gorkhabasti, Agartala-799 006	Tripura
28.	Devoted Organization for Reforming Environment (DORE), 196-B, Khari Bazar, Ranikhet-263645, Uttarakhand	Uttarakhand
29.	Shohratgarh Environmental Society, Prem Kunj, 9, Adarsh Colony, Shohratgarh, Siddharth Nagar Distt. 272 205 (U.P.)	Uttar Pradesh (East)
30.	School of Fundamental Research, 29, Pratapaditya Road, Kolkata- 700 026	West Bengal Except Darjeeling Hilly Areas and Sillyguri
31.	Federation of Societies for Environmental Protection (FOSEP), Darjeeling, Dr. S.M. Das Road, Red Cross Building, Darjelling-734101, West Bengal	Darjeeling Hilly Area & Siliguri
32.	Department of Environment& Forests, Office of the PCCF & Principle. Secretary., 'P'-Sector, Government of Arunachal Pradesh, Itanagar- 791 111	Arunachal Pradesh
33.	Department of Environment, Government of Meghalaya, Shillong-793 001.	Meghalaya
34.	State Environment Agency Forest, Environment and Wildlife Management Department, Government of Sikkim, Gangtok-737 101	Sikkim

## Audit Reports of Comptroller and Auditor General of India for the year 2008-09

### Scientific Departments (Compliance Audit – Report No. 16 of 2008-09)

#### MINISTRY OF ENVIRONMENT AND FORESTS

##### 6.1 Failure of village tree plantation project

Due to improper planning and lack of monitoring on part of National Afforestation and Eco-development Board, the objective of undertaking plantation of trees all over the country at a cost of Rs.5.87 crore was not achieved, defeating the purpose for which the project was sanctioned. Only an amount of Rs.2.34 crore could be spent on the scheme as of January 2009 by the states/UTs as per the utilisation certificates received in the Ministry.

##### 6.2 Inadmissible payment of Transport Allowance

Grant of Transport Allowance in violation of orders of Ministry of Finance led to inadmissible payment of Rs.67.66 lakh as transport allowance.

##### 6.3 Functioning of Central Zoo Authority, New Delhi

Central Zoo Authority (CZA) functioned only as a grant releasing agency instead of an agency to ensure conservation of endangered species of animals in zoos. CZA failed to ensure effective protection of animals/breeding programmes in the zoos. It had not fully identified the list of endangered species and undertook conservation breeding programmes for only three of the identified 63 endangered species. There was decrease in the number of endangered animals in the zoos all over the country due to high mortality. There was over-crowding of animals such as tigers, sambar/spotted deer, leopards etc., in a large number of zoos, much beyond the optimal number of animals prescribed under CZA guidelines. CZA was unaware as to whether the zoos were following the norms and regulations introduced by it for upkeep etc., to ensure the proper health of animals in zoos as it did not conduct any regular monitoring of the functioning of zoos. The system of financial management in CZA was also weak with CZA unable to monitor whether the funds released by it were actually being spent by the state zoos for the sanctioned purpose.

LIST OF ENVIS CENTRES

Sl.	Address	Communication Linkages	Subject Area
<b>ENVIS Institutional Centres (Subject Specific)</b>			
1	Dr. D.S. Kamyotra Member Secretary Shri Keyur Shah ENVIS Coordinator Central Pollution Control Board (CPCB) Parivesh Bhawan, CBD-Cum Office Complex, East Arjun Nagar, Delhi-110 032, Delhi	Phone: 011-22301932 Fax: 011-22304948, 22301932 Email: cpcb@envis.nic.in	Control of Pollution (Water, Air and Noise)
2	Dr. Ashwani Kumar Director Dr. (Mrs.) Poonam Kakkar ENVIS Coordinator Industrial Toxicological Research Centre(ITRC) Post Box No.80 Mahatma Gandhi Marg Lucknow-226 001, Uttar Pradesh	Phone: 0522-2284591, 2621856, 2613357, 2627586, 2613786 (Extn. 269, 305, 306,307) Mobile: 9335902630 Fax: 0522-2628227, 2611547 Email: itrc@envis.nic.in, envisiitr@envisiitr.org.in, director@iitrindia.org, ashwani26@rediffmail.com, poonam_kakkar@yahoo.com	Toxic Chemicals
3	Dr. H.N. Sayed Director Dr. Sunil Kumar Deputy Dir (Sr. Grade) & ENVIS Coordinator National Institute of Occupational Health(NIOH) Meghani Nagar Ahmedabad, Gujarat-380016	Phone: 079- 22686351,22686259 Fax: 079-22686361 Email: nioh@envis.nic.in	Environmental and Occupational Health
4	Prof. R. Sukumar Chairman Dr. T.V. Ramachandran ENVIS Coordinator Centre for Ecological Sciences - Indian Institute of Science (IISc) Bengaluru-560 012, Karnataka	Phone: 91-080-23600985, 22933099, 22932506 Fax: 91-080-23601428, 23600085, 23600683 Email: iisc@envis.nic.in	Western Ghats and Biological Diversity
5	Prof. T. Balasubramanian Director and ENVIS In-Charge Centre for Advanced Studies in Marine Biology(CASMB) Annamalai University, Parangipettai-608 502, Tamil Nadu	Phone: 04144-243223, 243533, 253089, 09443330214 Fax: 04144- 243555 Email: casmb@envis.nic.in, stbcas@nic.in, cdl_aucasmb@sancharnet.in	Mangroves, Estuaries, Lagoons, Coral Reefs

## Annual Report 2009-2010

Sl.	Address	Communication Linkages	Subject Area
6	Dr. Ramakrishna Director Dr. T.K. Pal ENVIS Coordinator Zoological Survey of India(ZSI) Prani Vigyan Bhawan, M Block, New Alipore, Kolkata-700053, West Bengal	Phone: 033-24008595, 24006893, 24003925 (Extn. 292) Mobile: 9433325558, 9433016738 Fax: 033-24006893 Email: zsi@envis.nic.in, tkpal51@rediffmail.com	Faunal Bio diversity
7	Prof. Gurdeep Singh ENVIS Coordinator Centre of Mining Environment (CME) Indian School of Mines Dhanbad-826004, Jharkhand	Phone: 0326-2296624 Fax: 0326-2296624, 2296603 Email: ism@envis.nic.in	Environmental Problems of Mining
8	Dr. S. Devotta Director Dr. T. Chakraborty ENVIS Coordinator National Environmental Engineering Research Institute(NEERI) Nehru Marg, Nagpur-440020, Maharashtra	Phone: 0712-2226026,2226071 Fax: 0712-2225191 Email: neeri@envis.nic.in	Hazardous Waste
9	Dr. L.M.S. Palni Director Dr. P.P. Dhyani ENVIS Coordinator G.B. Pant Institute of Himalayan Environment and Development Kosi - Katarmal Almora-263643, Uttarakhand	Phone: 05962-241041,241153 (Extn.54), 241015 Mobile: 09412092188, 09720335427 Fax: 05962-241014/15, 241150, 241153 Email: gbpihed@envis.nic.in, himenvis@gbpihed.nic.in, lmspalni@rediffmail.com, psdir@gbpihed.nic.in	Himalayan Ecology
10	Dr. M. Sanjappa Director Shri P.Lakshminarasimhan ENVIS Coordinator Botanical Survey of India(BSI) ENVIS Centre on Floral Diversity CNH Building, 3 <sup>rd</sup> Floor, Indian Botanic Garden, Howrah-711103 West Bengal	Phone: 033-26683235, 26680667 Fax: 033-26686226 Email: bsi@envis.nic.in, bsi_headquarter@rediffmail.com, envis@cal2.vsnl.net.in, m.sanjappa@nic.in, m_sanjappa@yahoo.co.in	Floral Biodiversity



## Ministry of Environment & Forests

Sl.	Address	Communication Linkages	Subject Area
11	Shri Jagdish Kiswan Director General Shri Shalendra Kaushik ENVIS Coordinator Forest Research Institute(FRI) Indian Council of Forestry Research Education New forest - P.O. Dehradun-248006, Uttarakhand	Phone: 0135-2756414 Fax: 0135-2756865 Email: fri@envis.nic.in	Forestry
12	Dr. P.R. Sinha Director Dr. V.B. Mathur ENVIS Coordinator Wildlife Institute of India(WII) PO Box NO. 18, Chandrabani Dehradun-248001, Uttarakhand	Phone: 0135-2640910, 2640304, 2040111-14 (Extn.202) Fax: 0135-2640117 Email: wii@envis.nic.in	Wildlife and Protected Area Management
13	Shri M.L. Arrawatia Secretary, Dept. of Science & Technology Shri Dorji Thinlay Bhutia ENVIS Coordinator Member Secretary & ENVIS In-charge State Council of Science and Technology for Sikkim (SCSTS) Deorali, Gangtok-737 102, Sikkim	Phone: 03592-208940, 205551 Fax: 0359-2208764, 2228764 Email: scsts@envis.nic.in	Eco-Tourism
14	Dr. K.P.R. Vittal Director Dr. D.C. Ojha ENVIS Coordinator Central Arid Zone Research Institute (CAZRI) Dr. Raheja Library Jodhpur-342 003, Rajasthan	Phone: 291-2740931, 2740706 Fax: 291-3000361 Email: cazri@envis.nic.in, tdas@cazri.res.in	Desertification
15	Dr. Paul P. Appasamy Director Dr. K.S. Kavi Kumar ENVIS Coordinator Madras School of Economics(MSE) Gandhi Mandampam Road Chennai-600 025, Tamil Nadu	Phone: 044-22352157 Fax: 044-22352155 Email: mse@envis.nic.in	Environmental Economics



## Annual Report 2009-2010

Sl.	Address	Communication Linkages	Subject Area
16	Prof. N. Munuswamy Hon. Director/ ENVIS Coordinator Department of Zoology - University of Madras Life Science Building, Guindy Campus, Chennai-600 025, Tamil Nadu	Phone: 044-22300899 Mobile: 09884171947, 09444895145 Fax: 044-22300899 Email: dzum@envis.nic.in, enviscoordinator@gmail.com, munuswamym@yahoo.com	Micro-organisms and environmental management
17	Dr. A. Jaygovind Director Dr. O.V. Nandimath ENVIS Coordinator National Law School of India University(NLSIU) Nagarbhavi, P.O.Box – 7201 Bangalore-560 072, Karnataka	Phone: 080-23213160, 23211303 Fax: 080-23217858 Email: nlsiu@envis.nic.in	Environmental Law
18	Prof. R. Ramesh Director Institute for Ocean Management(IOM) Anna University Chennai-600 025, Tamil Nadu	Phone: 044-22330108, 22200159, 22203408 Mobile: 9840966299 Fax: 044-22200158 Email: iom@envis.nic.in, rramesh_au@yahoo.com, ramesh@annauniv.edu	Coastal Regulation Zone Management and Coastal Shelter Belts
19	Dr. B.N. Goswami Director Dr. Gufran Beig Scientist & ENVIS Coordinator Indian Institute of Tropical Meteorology (IITM) Dr. Homi Bhabha Road, Pashan, Pune-411 008, Maharashtra	Phone: 020-25893600 (Extn. 261, 212) Mobile: 09423018580 Fax: 020-25893825 Email: iitm@envis.nic.in, pollution@tropmet.res.in, goswami@tropmet.res.in, beig@tropmet.res.in	Acid Rain and Atmospheric Pollution
20	Dr. J.S. Yadav Director Dr. U.Suryanarayana Murthy ENVIS Coordinator Indian Institute of Chemical Technology(IICT) Habsiguda, Uppal Road Hyderabad-500 007, Andhra Pradesh	Phone: 040-27193134 Fax: 040-27193227 Email: iict@envis.nic.in	Bioinformatics - Vector Control

## Ministry of Environment & Forests

Sl.	Address	Communication Linkages	Subject Area
21	Dr. M.O. Garg Director Dr. L.P. Singh ENVIS Coordinator Central Building Research Institute (CBRI) Roorkee-247 667, Uttarakhand	Phone: 01332-283442, 272391, 2722432 Mobile: 09837031050 Fax: 01332-272272, 272543 Email: cbri@envs.nic.in, singh_cbri@yahoo.co.in, director@cbrimail.com, lpsingh@cbri.in	Fly Ash
22	Dr. R. Tuli Director Dr. Nandita Singh ENVIS Coordinator National Botanical Research Institute (NBRI) Rana Pratap Marg Lucknow-226 001, Uttar Pradesh	Phone: 0522-2205842(303), 2205839 Mobile: 09415110314 Fax: 0522-2205847 Email: nbri@envs.nic.in, n.singh@nbri.res.in	Indicators of Plant Pollution
23	Shri. Bharat P. Jain Member Secretary Gujarat Cleaner Production Centre (GCPC) Block No.4, 3rd Floor, Udyog Bhawan, Sector-11, Gandhi Nagar-382 017, Gujarat	Phone: 079-23243211, 23225811-14 Fax: 079-3244306 Email: gcpc@envs.nic.in	Cleaner Production & Technology
24	Prof. Arabinda Kumar Das Vice Chancellor Prof. S.C. Santra ENVIS Coordinator Department of Environmental Sciences (DES) Kalyani University, Kalyani Distt. Nadia West Bengal - 741235	Phone: 033-25808749 Fax: 033-25828282 Email: scsantra@yahoo.com	Environmental Biotechnology
25	Prof. Shoben K. Saha Director Prof. Meenakshi Dhote ENVIS Coordinator School of Planning and Architecture (SPA) 4, Block Indraprastha Estate New Delhi-110002	Phone: 011-23702393, 95 Fax: 011-23702383 Email: spa-env@nic.in; epohd@vsnl.net	Human Settlement

## Annual Report 2009-2010

Sl.	Address	Communication Linkages	Subject Area
26	Prof. V.K. Jain ENVIS Coordinator School of Environmental Sciences Jawaharlal Nehru University, New Delhi-110067	Phone: 011-26704315 Fax: 26741502 Email: envis@mail.jnu.ac.in, cchatterjee@mail.jnu.ac.in	Biogeochemistry
27	Prof. Deepak Kumar Bagchi Vice Chancellor Prof. Subrata Maity ENVIS-In-charge Bidhan Chandra Krishi Viswavidyalaya Mohanpur, Nadia – 741252 West Bengal	Phone: 03473 223256/7 Extn. – 258, 033-25879772 Fax: 033 25828460, 03473 222275 Email: dk_bagchi@yahoo.com; maity@vsnl.com	Biosphere Reserve

### ENVIS NGO Centres (Subject Specific)

28	Dr. R.K. Pachauri Director General Shri P.K. Bhattacharya ENVIS Coordinator The Energy Resources Institute(TERI) Darbari Seth Block, Habitat Centre, Lodi Road New Delhi-110 003, Delhi	Phone: 011-24682100, 24682111 Fax: 011-24682144 Email: teri@envis.nic.in	Renewable Energy and Environment
29	Mr. Ravi Singh Secretary General and CEO Shri G. Areendran Director World Wide Fund for Nature - India(WWF) Indira Gandhi Conservation Monitoring Centre (IGCMC), 172-B, Lodhi Estate, New Delhi-110 003, Delhi	Phone: 011-41504791, 41504793 Mobile: 9968061056 Fax: 011-41504779, 24691226 Email: wwfindia@wwfindia.net, gareendran@wwfindia.net, ravisingh@wwfindia.net, rkumar@wwfindia.net	NGOs and Parliament
30	Shri. Kartikeya V. Sarabhai Director Mr. Ramesh Savalia ENVIS Coordinator Centre for Environment Education(CEE) Nehru Foundation for Development, Thaltej Tekra, Ahmedabad-380 054, Gujarat	Phone: 079-2684474526844780, 26858002-09, 26858011 Fax: 079-26858010 Email: cee@envis.nic.in, cee.envis@ceeindia.org, ceedo@ceeindia.org, ramesh.savalia@ceeindia.org	Environmental Education

## Ministry of Environment & Forests

Sl.	Address	Communication Linkages	Subject Area
31	Shri Inderjit Pal Director General Shri S.H. Baquer ENVIS Coordinator Environment Protection Training and Research Institute (EPTRI) 91/4, Gachibowli, Hyderabad-500 032, Andhra Pradesh	Phone: 040-23001242, 23000489, 23001707(D) Fax: 040-23000361 Email: eptri@envis.nic.in	Eastern Ghats
32	Dr. N. Baskara Rao Chairman Ms. Alka Tomar ENVIS Coordinator Centre for Media Studies (CMS) Research House, B-34, Community Centre, Saket, New Delhi-110 017, Delhi	Phone: 011-26851660, 26856429 Fax: 011-26968282 Email: cms@envis.nic.in	Communication and Electronic Media
33	Dr. Asad R. Rahmani Director Bombay Natural History Society (BNHS) Hornbill House, Dr. Salim Ali Chowk Shaheed Bhagat Singh road Mumbai-400 001, Maharashtra	Phone: 022-22821811 Fax: 022-22837615 Email: bnhs@envis.nic.in, bnhs@bnhs.org	Avian Ecology
34	Shri Kalyan Bose Hon. Director (Admn.) Mr. Jose Emmanuel ENVIS Coordinator Consumer Education and Research Centre (CERC) Suraksha Sankool, Thaltej, Sarkhej-Gandhinagar Highway, Ahmedabad-380 054, Gujarat	Phone: 079-27489945-46, 27450528, 27451097 Fax: 079-27489947 Email: cerc@envis.nic.in	Eco-Labeling and Eco-Friendly Products
35	Dr. (Mrs.) Nanditha C, Krishna Hon. Director CPR Environmental Education Centre (CPR) 1 Eldams Road, Alwarpet, Chennai-600 018, Tamil Nadu	Phone: 044-24346526, 24337023 Fax: 044-24320756 Email: cpreec@envis.nic.in	Conservation of Ecological Heritage and Sacred Sites in India
36	Dr. D.K. Ved Director Foundation for Revitalization of Local Health Traditions (FRLHT) 74/2, Jarakbande Kaval, Yelahanka, via Attu PO, Bangalore-560 064, Karnataka	Phone: 080-28565847, 28568007, 28565873 Fax: 080-28565895 Email: frlht@envis.nic.in	Conservation of Medicinal Plants

## Annual Report 2009-2010

Sl.	Address	Communication Linkages	Subject Area
37	Dr. Amiya Kumar Sahu President/ ENVIS Coordinator National Solid Waste Association of India (NSWAI) B-703, Customs Colony A, Marol, Military Road, Andheri (E), Mumbai – 400 059	Phone: 022-29207577 Telefax: 022-29202951 Email: nswai@envis.nic.in, econpcpl@gmail.com, econpcpl@vsnl.com, sahu_amiya@rediffmail.com	Municipal Solid Waste Management
38	Dr. Bindeshwar Pathak Founder Dr. S. Nath Chairman cum Medical Director Kumar Rajnish, Envis Coordinator Sulabh International Institute of Health and Hygiene (Sulabh) Sulabh Bhawan, Mahavir Enclave, New Delhi-110 045, Delhi	Phone: 011-25031243, 25058941 Fax: 011-25034014 Email: sulabh@envis.nic.in	Hygiene, Sanitation, Sewage Treatment Systems and Technology
39	Shri. K.G. Ramanathan President Shri. T.K. Bandopadhyay ENVIS Coordinator Indian Centre for Plastic in the Environment (ICPE) OLYMPUS House, 2nd Floor, 25, Raghunath Dadaji Street (Near Fort House - Formerly Handloom House) Fort, Mumbai – 400 001	Phone: 022-22617137, 22617165, 40022491 Fax: 022-22617168 Email: icpe@envis.nic.in	Management of Plastic, Polymers and Biopolymers
40	Dr. K.P. Nyati Director Environment Management Division – Confederation of Indian Industries (CII) India Habitat Centre 4th Floor, Core4A, Lodhi Road New Delhi-110 003, Delhi	Phone: 011-24682230-35 Fax: 011-24682229, 24682228 Email: cii@envis.nic.in	Industry - Government Environmental Interface
41	Dr. K.V. Swaminathan Chairman Mr. S.R. Adige ENVIS Coordinator Waterfalls Institute of Technology Transfer (WITT) J-29, NDSE Part-I New Delhi-110 049	Phone: 011-24642269 Fax: 011-24619083 Email: witt@envis.nic.in, witt_waterfall@yahoo.com	Environmental Audit and Accounting

## Ministry of Environment & Forests

Sl.	Address	Communication Linkages	Subject Area
42	Dr. P.A. Azeez Director Dr. S. Narendra Prasad ENVIS Coordinator Salim Ali Centre for Ornithology and Natural History (SACON) Anaikatty P.O. Coimbatore-641 108, Tamil Nadu	Phone: 0422-2657101-105, 2657086, 2657096 Fax: 0422-2657088 Email: sacon@envis.nic.in, narendra_prasad@yahoo.com	Wetland Ecosystem (including inland wetlands)
43	Dr. F. Ram Director Dr. R.B. Bhagat ENVIS Coordinator International Institute for Population Sciences(IIPS) Govandi Station Road, Deonar, Mumbai-400 088, Maharashtra	Phone: 022-25563254, 55, 56 (Extn.112, 173), 25573943, 25562062 Mobile: 09869947264 Fax: 022-25563257 Email: iip@envis.nic.in, popervis123@rediffmail.com, director@iips.net, rbbhagat@iips.net	Population, Human Settlement and Environment
44	Prof. B. Bhaskara Rao Director Dr.(Mrs.) Papia Lahiri ENVIS Coordinator Centre for Symbiosis of Technology, Environment and Management (STEM) Pocket B-10, Flat No. 7077, Vasant Kunj, New Delhi – 110070	Phone: 011-26122841, Mobile: 9350532857 Email: stemdel@gmail.com, papial2@yahoo.com	Women and Environment: their role in preservation and conservation of environment
45	Shri George C. Varughese President Ms. Sushmita Das ENVIS Coordinator Development Alternatives 111-Z/9, Kishangarh, Vasant Kunj, New Delhi – 110070	Phone: 011-26967938,26851158 Fax: 0111-26130814 Email: daervis@sdalt.ernet.in, amrita@sdalt.ernet.in	Environmentally Sound & Appropriate Technologies
46	Dr. Desh Bandhu President Indian Environmental Society (IES) Vidhata House, Vikas Marg, Shakarpur, Delhi-110092	Phone: 011-22046823,22450749 Fax: 011-22523311 Email: iesenro@del2.vsnl.net.in	Role of Panchayats in Environment

## Annual Report 2009-2010

Sl.	Address	Communication Linkages	Subject Area
<b>ENVIS Government Centres (State Government)</b>			
47	Mr. Rajeshwar Tiwari, IAS Director Dr. Razia Sultana ENVIS Coordinator Environment Protection Training and Research Institute (EPTRI) 91/4, Gachibowli, Hyderabad-500 032, Andhra Pradesh	Phone: 040-23001241, 23001242, 23006472, 23000489 (Extn. 17), 23001707(D) Fax: 040-23001241, 23000361 Email: ap@envis.nic.in, baquer@eptri.com, info@eptri.com	Status of Environment and Related Issues
48	Dr. Satyendra Kumar Choudhury Director Shri Jaideep Baruah ENVIS Coordinator Assam Science, Technology and Environmental Council Bigyan Bhawan, G.S. Road, Guwahati- 781005, Assam	Phone: 0361-2464619 Mobile: 09435032706, 09435102089 Telefax: 0361-2464617 Email: asm@envis.nic.in, astec-asm@nic.in, nverma2000@gmail.com, j.baruah@nic.in	Status of Environment and Related Issues
49	Shri. S.N. Rao Member Secretary Bihar State Pollution Control Board Beltron Bhawan, 2nd Floor, Lal Bhadur Shastri Nagar, Patna-800 023, Bihar	Phone: 0612-2281250, 2291709, 2281050 Fax: 0612-2291709, 2281050 Email: bh@envis.nic.in	Status of Environment and Related Issues
50	Shri Anil Kumar Sharma Member Secretary Mr. A.P. Savant ENVIS Coordinator, Asstt. Public Relation Officer Chhattisgarh Environment Conservation Board Nanak Niwas, Civil Lines, Raipur-492 001, Chhattisgarh	Phone: 0771-2425523 Fax: 0771-2425585 Email: cht@envis.nic.in	Status of Environment and Related Issues
51	Mrs. Naini Jayaseelan Secretary Environment Dr. B.C. Sabata Senior Scientific Officer Department of Environment - Govt. of NCT of Delhi Level-6, Wing-C, Delhi Secretariat, New Delhi-110 002, Delhi	Phone: 011-23392032, 23392029 Fax: 011-23392034 Email: del@envis.nic.in	Status of Environment and Related Issues

## Ministry of Environment & Forests

Sl.	Address	Communication Linkages	Subject Area
52	Dr. N.P.S. Varde Director/Jt. Secy. (STE) Dr. Mohan R. Girap ENVIS Coordinator Department of Science, Technology and Environment Saligao Plateau, Saligao Bardez-403 511, Goa	Phone: 0832-2407186 Fax: 0832-2407186 Email: goa@envis.nic.in	Status of Environment and Related Issues
53	Shri C.H. Pandya Director Shri Nischal Joshi Sr. Project Manager Gujarat Ecology Commission (GEC) Government of Gujarat, Block No.18/1, Udyog Bhavan, Sector-11, Gandhinagar-382017 Gujarat	Phone: 079-23257658, 23257659 Mobile: 09825030698 Fax: 079-23257656 Email: guj@envis.nic.in, gec_icef@rediffmail.com	Status of Environment and Related Issues
54	Dr. R.K. Sood Head of the Organisation Dr. Alka Sharma ENVIS Coordinator State Council for Science, Technology and Environment (SCSTE) B-34, SDA Complex, Kasumpti, Shimla-171 009, Himachal Pradesh	Phone: 0177-2622490,2620998, 2622923, 2633923 Fax: 0177-2620998 Email: hp@envis.nic.in	Status of Environment and Related Issues
55	Mrs. M.A.W. Deva ENVIS Coordinator Directorate of Environment and Remote Sensing SDA Complex, Bemina, Srinagar Phone: 0194-2490823 (May to October) 1-D, Gandhi Nagar, Jammu Phone: 0194-2438994 (November to April)	Phone: 0194-2438994 Telefax: 0194-2490823 Email: jk@envis.nic.in	Status of Environment and Related Issues
56	Shri. A.K. Mishra Chief Conservator of Forests –cum- Chief Wildlife Warden Shri Dharmendra Kumar Conservator of Forest Working Plan and Research Council Doranda, Ranchi-834 002, Jharkhand	Phone: 0651-2480655 Fax: 0651-2480655 Email: jhar@envis.nic.in	Status of Environment and Related Issues



## Annual Report 2009-2010

Sl.	Address	Communication Linkages	Subject Area
57	Mr. B. Basappa Director General Shri Chakravarti Mohan ENVIS Coordinator Environment Management & Policy Institute (EMPRI) Department of Forests, Environment and Ecology, Govt. of Karnataka, Hasiru Bhawan, Doresanipalya, Forest Campus, Vinayaka Nagar Circle, J.P. Nagar, 5 <sup>th</sup> Phase, Bangaluru- 560078, Karnataka	Phone: 080- 26490746, 26490747 22254377, 22092445 Fax: 080-26490745, 22254377 Email: kar@envis.nic.in, empri_bangalore@yahoo.co.in	Status of Environment and Related Issues
58	Dr. E.P. Yesodharan Executive Vice President Dr. Kamalakshan Kokkal Principal Scientific Officer & ENVIS Coordinator Kerala State Council for Science, Technology and Environment (KSCSTE) Sasthra Bhawan, Pattom P.O., Thiruvananthapuram-695 004, Kerala	Phone: 0471-2543701-05 Fax: 0471-2543558, 2540085 Email: ker@envis.nic.in, kscste@gmail.com, drkokkal@yahoo.com, krishnan.sabu@gmail.com	Status of Environment and Related Issues
59	Shri S.N. Mishra Executive Director Dr. Rakesh Dubey Director Disaster Management Institute(DMI) Housing and Environment Department, Paryavaran Parisar,E-5,Arera Colony,P.B.No.563, Bhopal-462 016, Madhya Pradesh	Phone: 0755-2466715, 2461538, 2461348, 5293592 Fax: 0755-2466653 Email: mp@envis.nic.in	Status of Environment and Related Issues
60	Dr. B.N. Patil ENVIS Coordinator Environment Department New Administrative Building, 15th Floor, Madam Cama Marg, Mantralaya, Mumbai-400 032, Maharashtra	Phone: 022-22854707, 22855082 Fax: 022-22025946 Email: mah@envis.nic.in, envis.maharashtra@gmail.com	Status of Environment and Related Issues
61	Dr. M. Homeshowor Singh Senior Scientific Officer Dr. Y. Nabachandra Singh ENVIS Coordinator Environment and Ecology Office - Dept. of Environment and Forests, Government of Manipur, Porompat Imphal (East)-795 010, Manipur	Phone: 0385-2227625 Mobile: 09862063880, 09436038970 Fax: 0385-2227625, 2446670 Email: man@envis.nic.in, brajakumar_t@yahoo.com	Status of Environment and Related Issues

## Ministry of Environment & Forests

Sl.	Address	Communication Linkages	Subject Area
62	Mr. C. Lalduhawma Member Secretary & ENVIS Coordinator Mizoram Pollution Control Board, Silver House, Tuikhuahtlang, Aizwal-796 001, Mizoram	Phone: 0389-2316590, 2326173, 231184, 09436142012 Fax: 0389-2316591, 2316590 Email: miz@envis.nic.in, duhawma15@yahoo.com, mpcb_azl@yahoo.com	Status of Environment and Related Issues
63	Dr. Seyiekhreipuo John Executive Director Dr. Inakhe Sumi Senior Programme Officer Nagaland Institute of Health, Environment and Social Welfare (NIHESW) Moses Complex, S-2, N.S.F., Martyr's Park, Upper PWD Kohima-797 001, Nagaland	Phone: 0370-2245619, 2245566 Mobile: 09436001470 Fax: 0370-2240626, 2245615, 2240180 Mob: 09436010783 Email: nag@envis.nic.in, nihesw@yahoo.com	Status of Environment and Related Issues
64	Shri Bhagirathi Behera Director Shri Pravat Mohan Dash ENVIS Coordinator Centre for Environmental Studies (CES) Forest & Environment Department, Government of Orissa, N-1/247, IRC Village, Nayapalli, Bhubaneswar-751 015, Orissa	Phone: 0674-2551853, 2390920, 2551853 Mobile: 09437011837, 09438186037 Fax: 0674-2553182 Email: ori@envis.nic.in, cesorissa@rediffmail.com, bhagirathibehera2002@yahoo.co.in, pravatmohandash@yahoo.com	Status of Environment and Related Issues
65	Mr. N.S. Tiwana Director Ms. Neelima Jerath ENVIS Coordinator Punjab State Council for Science and Technology(PSCST) MGSIPA Complex, Second Floor, Adj. Sacred Heart School, Sector-26 Chandigarh-160 019, Punjab	Phone: 0172- 2793600 Fax: 0172-2793143 Email: pun@envis.nic.in, neelimajerath@pscst.com	Status of Environment and Related Issues
66	Mr. Ashok Jain Chairperson Mr. Vijai Singhal ENVIS Coordinator Rajasthan State Pollution Control Board 4, Institutional Area, Jhalana Doongari, Jaipur-302 004, Rajasthan	Phone: 0141-2705731, 2707285, 2711263 Fax: 0141-2709980 Email: raj@envis.nic.in	Status of Environment and Related Issues

## Annual Report 2009-2010

Sl.	Address	Communication Linkages	Subject Area
67	Shri S.T. Lachungpa PCCF-cum-Secretary Shri C. Lachungpa Conservator of Forests & ENVIS Coordinator ENVIS Centre Sikkim, Forests, Environment & Wildlife Management Department, Government of Sikkim Forest Secretariat Annex-II, Ground Floor, Room No.1101/1102, Deorali, Gangtok-737 102, Sikkim (East)	Phone: 0359-2280381, 2281778 Fax: 0359-2280381, 2281778 Email: sik@envis.nic.in, pccfcumsecretary@gmail.com, st_lachungpa@hotmail.com, c_lachungpa123@hotmail.com, shrestha_kewal@yahoo.com	Status of Environment and Related Issues
68	Thiru. T.S. Srinivasamurthy I.F.S, Director of Environment Dr. C.Thomson Jacob Senior Programme Officer Department of Environment, Government of Tamil Nadu #1, Jeenis Road, 4th Floor Down, Panagal Building, Saidapet, Chennai-600 015, Tamil Nadu	Phone: 044-24331243, 24336421 Mobile: 09443243846, 09003071833 Fax: 044-24336594 Email: tn@envis.nic.in, tndoe@eth.net, tomson09@yahoo.co.in	Status of Environment and Related Issues
69	Prof. Mihir Deb Chairman Shri. Manas Mukherjee Executive Engineer & Project Co-ordinator Tripura State Pollution Control Board Vigyan Bhawan, Pandit Nehru Complex, Gorkhabasti, P.O. Kunjaban, Agartala-799 006, Tripura	Phone: 0381-2225421, 2328792,2300368@ Fax: 0381-2225421 Email: trp@envis.nic.in	Status of Environment and Related Issues
70	Shri. Yashpal Singh Director Shri R.K. Sardana ENVIS Coordinator Environment Directorate - Uttar Pradesh Vinit Khand-1, Gomti Nagar, Lucknow-226 020, Uttar Pradesh	Phone: 0522-2300541 Fax: 0522-2300543 Email: up@envis.nic.in	Status of Environment and Related Issues
71	Dr. T.B. Singh Chief Environment Officer Shri Amarjeet Singh Oberai Chief Environment Officer Uttarakhand Pollution Control Board E-115, Nehru Colony, Hardwar Road, Dehradun-248 011, Uttarakhand	Phone: 0135-2668922 Fax: 0135-2668092 Email: utr@envis.nic.in	Status of Environment and Related Issues

## Ministry of Environment & Forests

Sl.	Address	Communication Linkages	Subject Area
72	Shri M.L. Meena Principal Secretary Shri Arijit Banerjee Senior Environment Officer Department of Environment – Govt. of West Bengal Block 'G', 2 <sup>nd</sup> Floor, 2nd Floor, Writers' Buildings, Kolkata-700 001, West Bengal	Phone: 033-22141356, 22141357, 2214-5592 Fax: 033-22145592, 22141356 Email: wb@envis.nic.in	Status of Environment and Related Issues
73	Deputy Secretary Shri R.S. Sinha DCF, ENVIS Coordinator Department of Environment and Forest - Andaman and Nicobar Van Sadan, Haddo P.O. Port Blair-744 102, Andaman and Nicobar	Phone: 03192-233233 Fax: 03192-230113 Email: an@envis.nic.in	Status of Environment and Related Issues
74	Mr. Richard D'Souza Chairman Mr. Santosh Singh Member Secretary Daman Pollution Control Committee Moti Daman, Daman-396 220, Daman and Diu	Phone: 02638-2230963, 2230524 Fax: 02638-2230804 Email: dd@envis.nic.in	Status of Environment and Related Issues
75	Shri. Ishwar Singh Director, Mr. P.J.S. Dadhwal ENVIS Coordinator Department of Environment – Chandigarh Chandigarh Administration, Addl.Town Hall Building, 2nd Floor, Sector 17-C Chandigarh-160 001, Punjab	Phone: 0172-2700284 0172-2700065 0172-3295436 Fax: 0172- 2700149 Email: ch@envis.nic.in, dcf@chd.nic.in, dadhwalpjsd@gmail.com	Status of Environment and Related Issues
76	Shri M. Arunachalam Member Secretary Dr.K.Sundaravadivelu ENVIS Coordinator Puducherry Pollution Control Committee, Illrd Floor, Housing Board Building, Anna Nagar, Puducherry-605 005, Pondicherry	Phone: 0413-2201256 Mobile: 09443716026, 09442524264 Fax: 0413-2203494 Email: pon@envis.nic.in, ppcc.pon@nic.in, dste.pon@nic.in, drksundardste@rediffmail.com	Status of Environment and Related Issues



